



SHELVING
CARTS
WALL SHELVING
CABINETS & RACKS
WARE HANDLING
WORK STATIONS
FOOD CARRIERS



Delivering
Best-in-Class
**Shelving &
Cabinets**





Put the **PROS** to work.

In any service business, speed and accuracy are the key to customer satisfaction. The easier it is to be able to perform job tasks correlates directly to profitability and employee performance.

Metro-certified ESP Pro™ specialists evaluate your process, your product, and your purpose to provide a complete system designed to help you work.

Increase
productivity
up to
2X

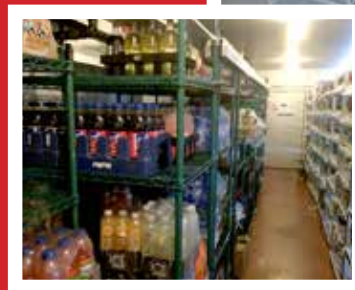

Increase
accessible
storage
up to
40%

Sure storage can be higher, or deeper...
or you may be able to squeeze in another
fixture, but does that actually serve you best?

Metro-certified ESP Pro™ specialists evaluate
all aspects of your process to provide space
that actually works for you.

Inform & socialize.

LIKE US ON FACEBOOK

Participate in the latest trends, Metro culture, contests, product offerings and more...

www.facebook.com/MetroFoodserviceSolutions

WATCH US ON YOUTUBE

See the latest how to videos, product informational videos and industry entertainment.

www.metro.com/YouTube



FLY WITH US ON TWITTER

Help spread information fast. Learn the latest Metro news and retweet what interests you!

www.twitter.com/MetroFS

REACH OUT ON INSTAGRAM

Interact with industry leading experts, operators and product specialists.

www.instagram.com/metrofoodservice

CONNECT ON LINKEDIN

Keep informed on latest industry trends, product opportunities, and Metro innovations.

www.linkedin.com/company/intermetroindustriescorp



Contents

Polymer Shelving Solutions.....8-29

- MetroMax Platform Overview.....10-11
- MetroMax i Shelves & Posts12-13
- MetroMax 4 Shelves & Posts14-15
- MetroMax Q Shelves & Posts16-17
- Casters, Pull & Push Handles18-19
- Mobile Shelving Units & Utility Carts20-21
- MetroMax Platform Accessories22-29

Wire and Solid Shelving Solutions32-79

- Wire/Polymer Hybrid Shelving32-35
- Easy-Adjust Shelving & Carts.....36-39
- Wire Shelving, Carts & Trucks.....40-49
- Casters & Accessories for Wire Shelving.....50-63
- qwikSLOT Adjustable Shelving.....66-71
- Shelving Storage Bins72-73
- Solid Shelving & Accessories74-76
- Light-Duty Wire Shelving & Accessories77
- Heavy-Duty Solid Shelving & Accessories78-79

Wall Shelving, Workstations & Worktables82-104

- SmartWall Grid & Wall Shelving82-90
- PrepMate MultiStations.....91-92
- SmartLever Multifunctional Workstations93-95
- SmartStation Productivity Workstations96-97
- Stainless Steel Worktables & Accessories98-101
- Heavy-Duty Work Tables & Accessories 102-104

High-Density Storage & Seismic Shelving..... 108-121

- High-Density Movable Aisle Shelving 108-118
- Vertical High-Density Shelving 119
- Seismic Shelving 120-121

Utility Carts, Dunnage & Security..... 124-137

- Polymer Utility Carts 124-127
- Wire & Solid Utility Carts 128-129
- Dunnage Racks & Shelves..... 130-131
- Security Storage..... 132-137

Insulated Food Carriers 138-143

- Mightylite Front Load Pan Carriers..... 140-141
- Mightylite Top Load Pan Carriers 142
- Mightylite Accessories 143



Thermal Cabinets & Racks 145-200

- C5® Cabinet Line & Accessories 146-187
 - Stationary and Mobile Holding Cabinets..... 146-177
 - Heavy-Duty Heated Transport Cabinets..... 178-183
 - Heavy-Duty Mobile Refrigerators..... 184-187
- Heated Banquet Cabinets & Accessories..... 188-194
- Holding/Delivery/Storage Cabinets 195-196
- Mobile Bun and Tray Racks 197-200



Ware Handling & Service Carts.....202-207

- “Poker Chip” Dish Dollies..... 204-205
- Side-Load Dish and Tray Carts206
- Ware Handling Racks/Carts & Accessories 206-207
- Ice Cart207



Housekeeping & Specialty.....208-221

- Lodgix Housekeeping Carts 210-211
- Lodgix Houserunner Carts & Folding Station.....212
- Valet and Amenity Carts & Stations 213-215
- Mini Bar Restocking Cart216
- Linen Trucks & Carts 217-218
- Totes & Bins.....218
- Merchandising219
- Beer and Wine Storage & Accessories 220-221



Terms and Conditions.....256-258

Index Inside Back Cover

Locations..... Back Cover





Metro® stands alone.

Leading the industry in stability, mobility and efficiency.



MetroMax® i	MetroMax® 4	MetroMax® Q	Super Erecta Pro™	Metroseal 3™	Chrome Plated & BRITE	Type 304 Stainless Steel
The strongest, most versatile, corrosion proof shelving system in the world.	Corrosion proof performance, proven Metro stability, and unrivaled value.	Quick adjustment, corrosion resistance and the strength of steel.	Durable & Cleanable. The Original...Reinnovated.	The Original Wire Shelving for Wet Environments.	Basic Storage and Transport for Dry Environments.	Long Life Use in the Toughest Environments.
★★★★ Wet Environment	★★★★ Wet Environment	★★★ Wet Environment	★★ Wet Environment	★★ Wet Environment	— Dry Environments	★★★★ Wet Environment
★★★★ Cleanability	★★★★ Cleanability	★★★★ Cleanability	★★★★ Cleanability	★★ Cleanability	★ Cleanability	★★ Cleanability
★★★★ Abrasion Resistance	★★★★ Abrasion Resistance	★★★★ Abrasion Resistance	★★★★ Abrasion Resistance	★★ Abrasion Resistance	★★★★ Abrasion Resistance	★★★★ Abrasion Resistance
1000lbs. (454kg) Shelf Capacity	800lbs. (363kg) Shelf Capacity	800lbs. (363kg) Shelf Capacity	800lbs. (363kg) Shelf Capacity	800lbs. (363kg) Shelf Capacity	800lbs. (363kg) Shelf Capacity	800lbs. (363kg) Shelf Capacity
\$\$\$\$ Relative Price	\$\$\$ Relative Price	\$\$\$ Relative Price	\$\$ Relative Price	\$ Relative Price	\$ Relative Price	\$\$\$\$ Relative Price



Superior materials and design for every application.

Robust Corners and Frames • Proven Stability
 Durable Finishes • Advanced Polymer Materials • Type 304 Stainless Steel
 Easy-to-Adjust in Increments of 1" (25mm)



MICROBAN® and the MICROBAN® symbol are registered trademarks of the Microban Products Company, Huntersville, NC.



SUPPORTS GOOD
HACCP
 PROCESSES

Metro incorporates several elements in its product design to support cleaning protocols:



- Microban® antimicrobial product protection helps keep shelves “cleaner between cleanings” by inhibiting the growth of mold, mildew, fungus, and bacteria that cause odors and stains on the shelf surface.
- Advanced polymer and other proprietary finishes provide corrosion resistance
- Smooth rounded corners to allow for easier cleaning

MetroMax® i:

The strongest, most versatile, corrosion proof shelving system in the world.



MetroMax® 4:

The Corrosion proof performance, proven Metro stability, and unrivaled value.



MetroMax® Q:

Quick adjustment, corrosion resistance and the strength of steel.



Super Adjustable Super Erecta®:

The easiest to adjust wire shelving system ever.



qwikSLOT®:

Add-A-Shelf, Remove-A-Shelf... Instantly.



Super Erecta Pro®:

Durable and Cleanable. The original – reinnovated.



Super Erecta®:

The Original Wire Storage and Handling System.



Drop Mat®:

Provides density and containment economically.



Super Erecta® Solid:

A solid performer in the proven Super Erecta style.



Take confidence to the max.

MetroMax[®] All-Polymer Shelving System



Safely Hold up to
2000 lbs.
per unit.





MetroMax Shelving

CORROSION PROOF POLYMER & HYBRID POLYMER/WIRE SHELVING

MetroMax Shelving Overview	10-11
MetroMax i Shelves & Posts	12-13
MetroMax 4 Shelves & Posts	14-15
MetroMax Q Shelves & Posts.....	16-17
Casters, Pull & Push Handles	18-19
Mobile Shelving Units & Utility Carts	20-21
MetroMax Accessories.....	22-29



MetroMax[®]

Forever Shelving.

Stronger,
cleaner,
superior
in any
environment.

Interchangeable Posts



Interchangeable Shelves



PLUS NEW
MetroMax 4
Grid Shelf (pictured)
or Solid Shelf



MetroMax Q
Grid Shelf



MetroMax i
Solid Shelf



MetroMax i
Grid Shelf



MetroMax i
Heavy-Duty
Grid Shelf



MetroMax[®] Q



GOOD



**RUST RESISTANT POLYMER
& COATED WIRE**
with Removable Shelf Mats

Quick adjustment, corrosion
resistance and the strength of steel.



15-YEAR
CORROSION WARRANTY



EASY-TO-CLEAN,
REMOVABLE MATS



HOLDS UP TO **1000 LBS**
(454kg) PER SHELF
2000 LBS (907kg) PER UNIT
1000 LBS (454kg) PER MOBILE UNIT

- DEPTHS: 18", 21", 24" [457, 530, 610mm]
- LENGTHS: 24/30/36/42/48/54/60/72"
[610/760/914/1060/1219/1372/1524/1829mm]



MetroMax® 4



BETTER



**100% RUST-PROOF
ALL-POLYMER**

Corrosion proof performance, proven Metro stability, and unrivaled value.



LIFETIME
CORROSION WARRANTY



EASY-TO-CLEAN,
REMOVABLE MATS



HOLDS UP TO **800 LBS**
(363kg) PER SHELF
2000 LBS (907kg) PER UNIT
750 LBS (340kg) PER MOBILE UNIT



TEAR RESISTANT
SURFACES

- DEPTHS: 18", 21", 24" [457, 530, 610mm]
- LENGTHS: 24/30/36/42/48/54/60"
[610/760/914/1060/1219/1372/1524mm]



MetroMax® i



BEST



**100% RUST-PROOF
ALL-POLYMER**
with Super Strong Stainless Steel Corners

The strongest, most versatile, corrosion proof shelving system in the world.



LIFETIME
CORROSION WARRANTY



EASY-TO-CLEAN,
REMOVABLE MATS



HOLDS UP TO **800 LBS**
(363kg) PER SHELF
2000 LBS (907kg) PER UNIT
1000 LBS (454kg) PER MOBILE UNIT



TEAR RESISTANT
SURFACES

- DEPTHS: 18", 24" [457, 610mm]
- LENGTHS: 24/30/36/42/48/54/60/72"
[610/760/914/1060/1219/1372/1524/1829mm]





MetroMax® i Polymer Shelving — {9.20}

Standard Shelves

- Part number includes shelf with removable mats and one bag of wedges.

	Nominal		Length		Approx. Pkd. Wt.		Cat. No. Shelf with Grid Mat	Approx. Pkd. Wt.		Cat. No. Shelf with Solid Mat
	Width (in.)	(mm)	(in.)	(mm)	(lbs.)	(kg)		(lbs.)	(kg)	
18	457	24	610	8.7	4.0	MX1824G	12.7	5.8	MX1824F	
18	457	30	760	10.5	4.7	MX1830G	14.5	6.6	MX1830F	
18	457	36	914	12.2	5.5	MX1836G	17.2	7.8	MX1836F	
18	457	42	1060	13.9	5.3	MX1842G	20.1	9.1	MX1842F	
18	457	48	1219	15.7	7.1	MX1848G	23.1	10.5	MX1848F	
18	457	54	1372	17.5	7.9	MX1854G	21.5	9.7	MX1854F	
18	457	60	1524	19.2	8.7	MX1860G	23.2	10.5	MX1860F	
18	457	72	1829	22.5	10.2	MX1872G	27.5	12.5	MX1872F	
24	610	24	610	12.2	5.5	MX2424G	14.2	6.4	MX2424F	
24	610	30	760	13.9	6.3	MX2430G	15.9	7.2	MX2430F	
24	610	36	914	15.6	7.1	MX2436G	19.6	8.9	MX2436F	
24	610	42	1060	17.5	7.9	MX2442G	21.5	9.8	MX2442F	
24	610	48	1219	19.3	8.7	MX2448G	25.3	11.5	MX2448F	
24	610	54	1372	21.0	9.5	MX2454G	25.0	11.3	MX2454F	
24	610	60	1524	22.8	10.5	MX2460G	26.8	12.1	MX2460F	
24	610	72	1829	26.0	11.8	MX2472G	31.0	14.1	MX2472F	

Actual Dimensions: Width: Add 1/4" (6mm) to nominal size. Length: Subtract 1/4" (6mm) from nominal size.
Maximum weight capacity evenly distributed: Up to and including 48" (1220mm) long shelf, 1000 lbs. (454kg); 54" (1372mm) and longer, 750 lbs. (340kg).



Standard shelf with solid mat



Standard shelf with grid mat



Heavy-duty grid shelf

Heavy-Duty Dunnage Shelves

- Weight capacity per shelf evenly distributed: 1,200 lbs. (544kg) on shelves up to and including 48" (1220mm) long; 900 lbs. (408kg) for shelves 60" (1524mm) long.

	Nominal Width		Length		Approx. Pkd. Wt.		Cat. No. Shelf with Grid Mat
	(in.)	(mm)	(in.)	(mm)	(lbs.)	(kg)	
24	610	36	914	21	9.5	MHP2436G	
24	610	48	1220	27	12.2	MHP2448G	
24	610	60	1524	33	15.0	MHP2460G	

(Dunnage shelves are not recommended for use as part of an add-on unit with two posts.)

Polymer Posts

- Corrosion proof with built-in Microban antimicrobial product protection.
- Stationary posts include an adjustable leveling foot to compensate for uneven floors. Leveling foot can be adjusted 1" (25mm).

Nominal Height (in.)	(mm)	Approx. Pkd. Wt.		Cat. No. Stationary Post with Leveling Foot	Cat. No. Mobile Post for Stem Caster
		(lbs.)	(kg)		
9	228	0.3	0.15	—	MX9UP
13	330	0.5	0.2	MX13P	MX13UP
27	685	0.9	0.4	MX27P	MX27UP
33	838	1.0	0.5	MX33P	MX33UP
54	1372	1.6	0.7	MX54P	MX54UP
63	1600	1.8	0.8	MX63P	MX63UP
74	1880	2.2	1.0	MX74P	MX74UP
86	2184	3.0	1.4	MX86P	MX86UP

(Special height cut posts are available. Consult your Metro representative.)



MetroMax® i Replacement Wedges

Bag of (4)
 Cat. No. **MX9985**
 MetroMax® i Wedges are not compatible with original MetroMax shelves and posts.



Post Clamp

Adds stability by joining posts of two separate units together. With it, each unit is supported by four posts and buttressed by the adjacent unit.
 Cat. No. **9994X**



Foot Plate

Use to add stability to the shelving unit or to bolt units to the floor.
 Cat. No. **Zinc 9993Z**
 Cat. No. **Stainless Steel 9993S**

NOTE: For maximum rigidity on heavily loaded carts, the steel posts may be used. See page 16 for models.

Note: MetroMax® i shelves, posts, and wedges are not compatible with original MetroMax shelves and posts.

MetroMax® i Shelving Starter and Add-On Units – {9.10}

- Starter Units consist of four polymer posts and indicated number of MetroMax i shelves.
- Add-On Units consist of two polymer posts, indicated number of shelves, and two “S” Hooks per shelf, for attaching add-on unit to starter unit in an end-to-end configuration. To attach shelves at right angles, Intermediate “S” Hook Kits must be ordered separately.

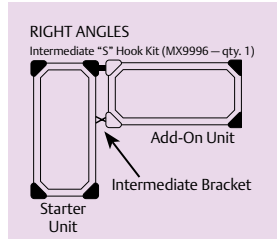
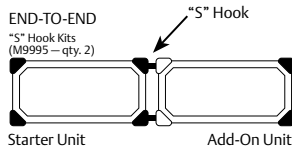

- Regular “S” Hook location
- ✗ Intermediate bracket location
- Post
- Post not required



Add-On units with “S” hooks can only be attached to shelves supported by two or more posts.

4-Tier Unit with 63" posts

Nominal Width/Length (in.)	Nominal Width/Length (mm)	Approx. Pkd. Wt. (lbs.)	Approx. Pkd. Wt. (kg)	Cat. No. Starter Unit	Approx. Pkd. Wt. (lbs.)	Approx. Pkd. Wt. (kg)	Cat. No. Add-On Unit
18x24	457x610	48.0	21.8	X316GX3	44.0	20.0	AX316GX3
18x30	457x760	52.0	23.6	X326GX3	48.0	21.8	AX326GX3
18x36	457x914	56.0	25.4	X336GX3	52.0	23.6	AX336GX3
18x42	457x1060	64.0	29.0	X346GX3	60.0	27.2	AX346GX3
18x48	457x1219	72.0	32.7	X356GX3	68.0	30.8	AX356GX3
18x60	457x1524	88.0	39.9	X366GX3	84.0	38.1	AX366GX3
18x72	457x1829	100.0	45.4	X376GX3	96.0	43.5	AX376GX3
24x24	610x610	54.0	24.5	X516GX3	50.0	22.7	AX516GX3
24x30	610x760	64.0	29.0	X526GX3	60.0	27.2	AX526GX3
24x36	610x914	68.0	30.8	X536GX3	64.0	29.0	AX536GX3
24x42	610x1060	76.0	34.5	X546GX3	72.0	32.7	AX546GX3
24x48	610x1219	84.0	38.1	X556GX3	80.0	36.3	AX556GX3
24x60	610x1524	92.0	41.7	X566GX3	88.0	39.9	AX566GX3
24x72	610x1829	116.0	52.6	X576GX3	112.0	50.8	AX576GX3

Actual Dimensions: Width: Add 1/4" (6mm) to nominal size.
Length: Subtract 1/4" (6mm) from nominal size.

5-Tier Unit with 74" posts

Approx. Pkd. Wt. (lbs.)	Approx. Pkd. Wt. (kg)	Cat. No. Starter Unit	Approx. Pkd. Wt. (lbs.)	Approx. Pkd. Wt. (kg)	Cat. No. Add-On Unit
60.0	27.2	5X317GX3	55.0	24.9	5AX317GX3
65.0	29.5	5X327GX3	60.0	27.2	5AX327GX3
70.0	31.8	5X337GX3	65.0	29.5	5AX337GX3
80.0	36.3	5X347GX3	75.0	34.0	5AX347GX3
90.0	40.8	5X357GX3	85.0	38.6	5AX357GX3
110.0	49.9	5X367GX3	105.0	47.6	5AX367GX3
125.0	56.7	5X377GX3	120.0	54.4	5AX377GX3
65.0	29.5	5X517GX3	60.0	27.2	5AX517GX3
80.0	36.3	5X527GX3	75.0	34.0	5AX527GX3
85.0	38.6	5X537GX3	80.0	36.3	5AX537GX3
95.0	43.1	5X547GX3	90.0	40.8	5AX547GX3
105.0	47.6	5X557GX3	100.0	45.4	5AX557GX3
115.0	52.2	5X567GX3	110.0	49.9	5AX567GX3
145.0	65.8	5X577GX3	140.0	63.5	5AX577GX3

5-Tier Unit with 74" posts (4) Grid (1) Solid Shelves

Nominal Width/Length (in.)	Nominal Width/Length (mm)	Approx. Pkd. Wt. (lbs.)	Approx. Pkd. Wt. (kg)	Cat. No. Starter Unit
18x24	457x610	56.4	25.6	5X317HX3
18x36	457x914	74.8	33.9	5X337HX3
18x48	457x1219	94.5	42.9	5X357HX3
18x60	457x1524	108.8	49.4	5X367HX3

Actual Dimensions: Width: Add 1/4" (6mm) to nominal size
Length: Subtract 1/4" (6mm) from nominal size.

5-Tier Unit with 74" posts (4) Grid (1) Solid Shelves

Nominal Width/Length (in.)	Nominal Width/Length (mm)	Approx. Pkd. Wt. (lbs.)	Approx. Pkd. Wt. (kg)	Cat. No. Starter Unit
24x24	610x610	71.7	32.5	5X517HX3
24x36	610x914	91.0	41.3	5X537HX3
24x48	610x1219	111.1	50.4	5X557HX3
24x60	610x1524	126.6	57.4	5X567HX3

Needed for Corner (Right Angle) Configurations

Corner Add-on “S” Hook Kits – {9.10}

For Add-on Units.



x4

Four-tier Corner Unit
Cat. No. MXCNR4



x5

Five-tier Corner Unit
Cat. No. MXCNR5

“S” Hook Kits – {9.25} For individual shelves.



MetroMax® i “S” Hook Kit

Add on shelving to existing units using two posts instead of four. Kit includes one “S” hook and one corner adapter plug. Two kits required per storage level when configuring units end-to-end.
Cat. No. M9995



MetroMax® i Intermediate “S” Hook Kit

Required when joining units at right angles with open corner and no post. Intermediate bracket connects a shelf corner to the front beam of the adjoining shelf. Kit includes one intermediate bracket, two “S” Hooks, and two corner adapter plugs. One required per storage level.
Cat. No. MX9996



Corner adapter (plug)
fits MetroMax i



MetroMax® 4 Polymer Shelves — {9.22}

Standard Shelves.

- All-polymer shelves with removable 6" (152mm) wide shelf mats.
- Compatible on the same shelving units with MetroMax i and MetroMax Q shelves.
- Part number includes shelf with removable shelf mats and one bag of wedges.

Nominal Width/Length (in.) (mm)		Approx. Pkd. Wt. (lbs.) (kg)		Cat. No. Shelf w/ grid Mats	Approx. Pkd. Wt. (lbs.) (kg)		Cat. No. Shelf w/ Solid Mats
18x24	457x610	6.3	2.9	MAX4-1824G	6.5	3.0	MAX4-1824F
18x30	457x760	7.4	3.4	MAX4-1830G	7.7	3.5	MAX4-1830F
18x36	457x914	8.8	4.0	MAX4-1836G	9.2	4.2	MAX4-1836F
18x42	457x1060	9.6	4.3	MAX4-1842G	10.0	4.5	MAX4-1842F
18x48	457x1219	10.8	4.9	MAX4-1848G	11.3	5.1	MAX4-1848F
18x54	457x1372	11.7	5.3	MAX4-1854G	12.3	5.6	MAX4-1854F
18x60	457x1524	12.8	5.8	MAX4-1860G	13.5	6.1	MAX4-1860F
21x24	530x610	6.9	3.1	MAX4-2124G	7.2	3.2	MAX4-2124F
21x30	530x760	8.1	3.7	MAX4-2130G	8.5	3.8	MAX4-2130F
21x36	530x914	9.6	4.4	MAX4-2136G	10.1	4.6	MAX4-2136F
21x42	530x1060	10.5	4.8	MAX4-2142G	11.0	5.0	MAX4-2142F
21x48	530x1219	11.9	5.4	MAX4-2148G	12.5	5.7	MAX4-2148F
21x54	530x1372	12.9	5.9	MAX4-2154G	13.6	6.2	MAX4-2154F
21x60	530x1524	14.2	6.4	MAX4-2160G	15.0	6.8	MAX4-2160F
24x24	610x610	7.3	3.3	MAX4-2424G	7.8	3.5	MAX4-2424F
24x30	610x760	8.8	4.0	MAX4-2430G	9.3	4.2	MAX4-2430F
24x36	610x914	10.5	4.8	MAX4-2436G	11.0	5.0	MAX4-2436F
24x42	610x1060	11.8	5.4	MAX4-2442G	12.3	5.6	MAX4-2442F
24x48	610x1219	13.1	5.9	MAX4-2448G	13.9	6.3	MAX4-2448F
24x54	610x1372	14.3	6.5	MAX4-2454G	15.4	7.0	MAX4-2454F
24x60	610x1524	15.5	7.0	MAX4-2460G	17.0	7.7	MAX4-2460F



Removable
wash-machine friendly mats.



Actual Dimensions: Width: Add 1/2" (13mm) to nominal size. Length: Subtract 1/16" (1.6mm) from nominal size.

Maximum weight capacity evenly distributed: up to and including 48" (1219mm) long shelf, 800 lbs. (363kg); 54" (1372mm) and larger, 600 lbs. (272kg).

NOTE: For extra heavy loads exceeding 800 lbs. MetroMax i shelves can be added to MetroMax 4 units.

Polymer Posts

- Corrosion proof with built-in Microban antimicrobial product protection.
- Stationary posts include an adjustable leveling foot to compensate for uneven floors. Leveling foot can be adjusted 1" (25mm).



Nominal Height (in.) (mm)	Approx. Pkd. Wt. (lbs.) (kg)	Cat. No. Stationary Post with Leveling Foot	Cat. No. Mobile Post for Stem Caster		
9	228	0.3	0.15	—	MX9UP
13	330	0.5	0.2	MX13P	MX13UP
27	685	0.9	0.4	MX27P	MX27UP
33	838	1.0	0.5	MX33P	MX33UP
54	1372	1.6	0.7	MX54P	MX54UP
63	1600	1.8	0.8	MX63P	MX63UP
74	1880	2.2	1.0	MX74P	MX74UP
86	2184	3.0	1.4	MX86P	MX86UP

(Special height cut posts are available. Consult your Metro representative.)

NOTE: For maximum rigidity on heavily loaded carts, the steel posts may be used. See page 16 for models.



MetroMax® 4 Replacement Wedges

Bag of (4)
Cat. No. MAX4-9985



Post Clamp

Adds stability by joining posts of two separate units together. With it, each unit is supported by four posts and buttressed by the adjacent unit.
Cat. No. 9994X



Foot Plate

Use to add stability to the shelving unit or to bolt units to the floor.
Cat. No. Zinc 9993Z
Cat. No. Stainless Steel 9993S



METROMAX® 4 SHELVES AND POSTS

MetroMax® 4 Shelving Starter and Add-On Units {9.12}

- Starter Units consist of four polymer posts and indicated number of MetroMax 4 shelves.
- Add-On Units consist of two polymer posts, indicated number of shelves, and two “S” Hooks per shelf, for attaching add-on unit to starter unit in an end-to-end configuration. To attach shelves at right angles, Corner “S” Hook Kits must be ordered separately.

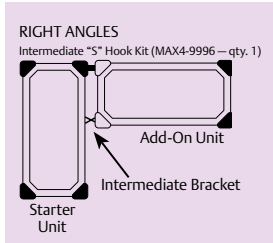
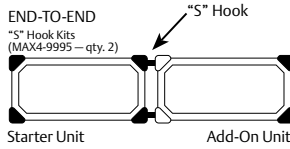

- Regular “S” Hook location
- ✕ Intermediate bracket location
- ▲ Post
- Post not required

Add-On units with “S” hooks can only be attached to shelves supported by two or more posts.

4-Tier Grid Shelf Unit with 63" posts

Nominal Width/Length (in.)	Nominal Width/Length (mm)	Approx. Pkd. Wt. (lbs.)	Approx. Pkd. Wt. (kg)	Cat. No. Starter Unit	Approx. Pkd. Wt. (lbs.)	Approx. Pkd. Wt. (kg)	Cat. No. Add-On Unit
18x24	457x610	32.5	14.7	X316G4	30.5	13.8	AX316G4
18x30	457x760	36.9	16.7	X326G4	34.9	15.8	AX326G4
18x36	457x914	42.6	19.3	X336G4	40.6	18.4	AX336G4
18x42	457x1060	45.5	20.7	X346G4	43.5	19.8	AX346G4
18x48	457x1219	50.3	22.8	X356G4	48.3	21.9	AX356G4
18x60	457x1524	58.6	26.6	X366G4	56.6	25.7	AX366G4
21x24	530x610	34.8	15.8	X416G4	32.8	14.9	AX416G4
21x30	530x760	39.7	18.0	X426G4	37.7	17.1	AX426G4
21x36	530x914	45.7	20.7	X436G4	43.7	19.8	AX436G4
21x42	530x1060	49.3	22.4	X446G4	47.3	21.5	AX446G4
21x48	530x1219	54.7	24.8	X456G4	52.7	23.9	AX456G4
21x60	530x1524	63.9	29.0	X466G4	61.9	28.1	AX466G4
24x24	610x610	36.4	16.5	X516G4	34.4	15.6	AX516G4
24x30	610x760	42.4	19.2	X526G4	40.4	18.3	AX526G4
24x36	610x914	49.2	22.3	X536G4	47.2	21.4	AX536G4
24x42	610x1060	54.4	24.7	X546G4	52.4	23.8	AX546G4
24x48	610x1219	59.6	27.0	X556G4	57.6	26.1	AX556G4
24x60	610x1524	69.2	31.4	X566G4	67.2	30.5	AX566G4

Actual Dimensions: Width: Add 1/2" (13mm) to nominal size. Length: Subtract 1/8" (2mm) from nominal size.

5-Tier Grid Shelf Unit with 74" posts

Approx. Pkd. Wt. (lbs.)	Approx. Pkd. Wt. (kg)	Cat. No. Starter Unit	Approx. Pkd. Wt. (lbs.)	Approx. Pkd. Wt. (kg)	Cat. No. Add-On Unit
40.4	18.3	5X317G4	38.0	17.2	5AX317G4
45.9	20.8	5X327G4	43.5	19.7	5AX327G4
53.0	24.1	5X337G4	50.6	23.0	5AX337G4
56.7	25.7	5X347G4	54.3	24.6	5AX347G4
62.7	28.4	5X357G4	60.3	27.4	5AX357G4
73.0	33.1	5X367G4	70.6	32.0	5AX367G4
43.3	19.6	5X417G4	40.9	18.5	5AX417G4
49.4	22.4	5X427G4	47.0	21.3	5AX427G4
56.9	25.8	5X437G4	54.5	24.7	5AX437G4
61.4	27.9	5X447G4	59.0	26.8	5AX447G4
68.2	30.9	5X457G4	65.8	29.8	5AX457G4
79.7	36.1	5X467G4	77.3	35.0	5AX467G4
45.3	20.5	5X517G4	42.9	19.5	5AX517G4
52.8	23.9	5X527G4	50.4	22.9	5AX527G4
61.3	27.8	5X537G4	58.9	26.7	5AX537G4
67.8	30.8	5X547G4	65.4	29.7	5AX547G4
74.3	33.7	5X557G4	71.9	32.6	5AX557G4
86.3	39.1	5X567G4	83.9	38.1	5AX567G4

5-Tier Unit with 74" posts (4) Grid (1) Solid Shelves

Nominal Width/Length (in.)	Nominal Width/Length (mm)	Approx. Pkd. Wt. (lbs.)	Approx. Pkd. Wt. (kg)	Cat. No. Starter Unit
18x24	457x610	40.6	18.4	5X317H4
18x36	457x914	53.4	24.2	5X337H4
18x48	457x1219	63.2	28.7	5X357H4
18x60	457x1524	73.7	33.4	5X367H4

Actual Dimensions: Width: Add 1/2" (13mm) to nominal size. Length: Subtract 1/8" (2mm) from nominal size.

5-Tier Unit with 74" posts (4) Grid (1) Solid Shelves

Nominal Width/Length (in.)	Nominal Width/Length (mm)	Approx. Pkd. Wt. (lbs.)	Approx. Pkd. Wt. (kg)	Cat. No. Starter Unit
24x24	610x610	45.8	20.8	5X517H4
24x36	610x914	61.8	28.0	5X537H4
24x48	610x1219	75.1	34.1	5X557H4
24x60	610x1524	87.8	39.8	5X567H4

Needed for Corner (Right Angle) Configurations

Corner Add-on “S” Hook Kits – {9.12}

For Add-on Units.



Four-tier Corner Unit
Cat. No. MAX4-CNR4



Five-tier Corner Unit
Cat. No. MAX4-CNR5

“S” Hook Kits – {9.25} For individual shelves.



Intermediate “S” Hook Kit

MetroMax® 4 Intermediate “S” Hook Kit

Required when joining units at right angles with open corner and no post. Kit includes one intermediate bracket, one “S” Hooks, and two corner adapter plugs.
Cat. No. MAX4-9996



Standard “S” Hook Kit

MetroMax® 4 “S” Hook Kit

Kit includes one “S” hook and one corner adapter plug. Two kits required per storage level when configuring units end-to-end.
Cat. No. MAX4-9995



MetroMax® Q Shelving — {9.21}
Standard Shelves

- Part number includes shelf with removable mats and one bag of wedges.

	Width (in.)	Nominal		Approx. Pkd. Wt.		Cat. No. Shelf with Grid Mats
		(mm)	Length (in.)	(mm)	(lbs.) (kg)	
18	457	24	610	6.2	2.8	MQ1824G
18	457	30	760	8.0	3.6	MQ1830G
18	457	36	914	9.7	4.4	MQ1836G
18	457	42	1060	11.4	5.2	MQ1842G
18	457	48	1219	13.2	6.0	MQ1848G
18	457	54	1372	15.0	6.8	MQ1854G
18	457	60	1524	16.7	7.6	MQ1860G
18	457	72	1829	20.0	9.1	MQ1872G
21	530	24	610	8.0	3.6	MQ2124G
21	530	30	760	9.7	4.4	MQ2130G
21	530	36	914	11.4	5.2	MQ2136G
21	530	42	1060	12.8	5.8	MQ2142G
21	530	48	1219	14.5	6.6	MQ2148G
21	530	54	1372	16.7	7.6	MQ2154G
21	530	60	1524	18.5	8.4	MQ2160G
21	530	72	1829	21.7	9.9	MQ2172G
24	610	24	610	9.7	4.4	MQ2424G
24	610	30	760	11.4	5.2	MQ2430G
24	610	36	914	13.1	6.0	MQ2436G
24	610	42	1060	14.1	6.4	MQ2442G
24	610	48	1219	15.8	7.1	MQ2448G
24	610	54	1372	18.5	8.4	MQ2454G
24	610	60	1524	20.3	9.2	MQ2460G
24	610	72	1829	23.5	10.7	MQ2472G

Actual Dimensions: Width: Add 3/8" (10mm) to nominal size.
Length: Subtract 3/16" (5mm) from nominal size.
Maximum weight capacity evenly distributed: Up to and including 48" (1220mm) long shelf, 800 lbs. (363kg); 54" (1372mm) and longer, 600 lbs. (272kg).
NOTE: The current MetroMax® Q shelves with the blue S-hook plugs have different actual measurements than original MetroMax Q shelves manufactured in March 2009 and earlier and cannot be mixed on the same shelving units.

Removable
wash-machine friendly mats.



Posts

- Epoxy coated steel and polymer posts have Microban antimicrobial product protection.
- Stationary posts include an adjustable leveling foot to compensate for uneven floors. Leveling foot can be adjusted 1" (25mm).
- When mounting a shelving unit to a dolly base, stationary posts are used.



1" Shelves adjust at 1" increments.
(25mm)



MetroMax® Q Replacement Wedges

Bag of (4)
Cat. No. MQ9985

MetroMax® Q Wedges are compatible with original MetroMax Q shelves and posts.

Nominal Height (in.) (mm)	Approx. Pkd. Wt.		Cat. No. Stationary Post with Leveling Foot		Cat. No. Mobile Post for Stem Caster		Approx. Pkd. Wt.		Cat. No. Stationary Post with Leveling Foot		Cat. No. Mobile Post for Stem Caster	
	(lbs.)	(kg)					(lbs.)	(kg)				
9 228	0.3	0.15	—	—	—	—	—	—	—	—	—	MX9UP
13 370	1.0	0.5	MQ13PE	MQ13UPE	0.5	0.2	MX13P	MX13UP				
27 685	2.0	0.9	MQ27PE	MQ27UPE	0.9	0.4	MX27P	MX27UP				
33 875	2.5	1.1	MQ33PE	MQ33UPE	1.0	0.5	MX33P	MX33UP				
54 1370	4.0	1.8	MQ54PE	MQ54UPE	1.6	0.7	MX54P	MX54UP				
63 1585	4.5	2.0	MQ63PE	MQ63UPE	1.8	0.8	MX63P	MX63UP				
70 1778	5.0	2.3	—	MQ70UPE	—	—	—	—				
74 1890	5.5	2.5	MQ74PE	MQ74UPE	2.2	1.0	MX74P	MX74UP				
86 2195	6.5	2.9	MQ86PE	MQ86UPE	3.0	1.4	MX86P	MX86UP				

(Special height cut posts are available. Consult your Metro representative.)



MetroMax® Q Shelving Starter and Add-On Units — {9.11}

- Starter Units consist of four epoxy-coated steel posts and indicated number of MetroMax Q shelves.
- Add-On Units consist of two epoxy-coated steel posts, indicated number of shelves, and two “S” Hooks per shelf, for attaching shelf to adjacent unit in an end-to-end configuration. To attach shelves at right angles, Intermediate “S” Hook Kits must be ordered separately.

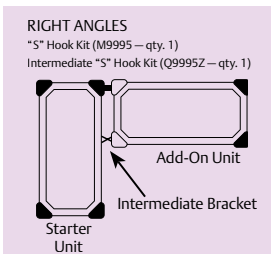
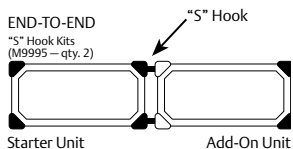

Regular “S” Hook location
 Intermediate bracket location
 Post
 Post not required

Add-On units with “S” hooks can only be attached to shelves supported by two or more posts.



4-Tier Unit with 63" posts

Nominal Width/Length (in.) (mm)	Approx. Pkd. Wt. (lbs.) (kg)	Cat. No. Starter Unit	Approx. Pkd. Wt. (lbs.) (kg)	Cat. No. Add-On Unit
18x24 457x610	41.5 18.8	Q316G3	32.5 14.7	AQ316G3
18x30 457x760	47.5 21.5	Q326G3	34.5 15.6	AQ326G3
18x36 457x914	53.5 24.3	Q336G3	40.5 18.4	AQ336G3
18x42 457x1060	59.5 27.0	Q346G3	46.5 21.1	AQ346G3
18x48 457x1219	65.5 29.7	Q356G3	65.2 29.6	AQ356G3
18x60 457x1524	53.5 24.3	Q366G3	64.5 29.3	AQ366G3
18x72 457x1829	89.5 40.6	Q376G3	86.5 39.2	AQ376G3
21x24 530x610	46.3 21.0	Q416G3	34.3 15.6	AQ416G3
21x30 530x760	52.3 23.7	Q426G3	39.3 17.8	AQ426G3
21x36 530x914	57.9 26.3	Q436G3	44.9 20.4	AQ436G3
21x42 530x1060	67.1 30.4	Q446G3	54.1 24.5	AQ446G3
21x48 530x1219	72.7 33.0	Q456G3	59.7 27.1	AQ456G3
21x60 530x1524	86.3 39.1	Q466G3	73.3 33.2	AQ466G3
21x72 530x1829	98.3 44.6	Q476G3	85.3 38.7	AQ476G3
24x24 610x610	49.5 22.5	Q516G3	36.5 16.6	AQ516G3
24x30 610x760	57.5 26.1	Q526G3	44.5 20.2	AQ526G3
24x36 610x914	65.5 29.7	Q536G3	52.5 23.8	AQ536G3
24x42 610x1060	73.5 33.3	Q546G3	60.5 27.4	AQ546G3
24x48 610x1219	81.5 37.0	Q556G3	68.5 31.1	AQ556G3
24x60 610x1524	77.5 35.2	Q566G3	84.5 38.3	AQ566G3
24x72 610x1829	113.5 51.5	Q576G3	100.5 45.6	AQ576G3

Actual Dimensions: Width: Add 3/8" (10mm) to nominal size. Length: Subtract 3/16" (5mm) from nominal size.

5-Tier Unit with 74" posts

Approx. Pkd. Wt. (lbs.) (kg)	Cat. No. Starter Unit	Approx. Pkd. Wt. (lbs.) (kg)	Cat. No. Add-On Unit
50.4 22.9	5Q317G3	40.4 18.3	5AQ317G3
57.9 26.3	5Q327G3	47.9 21.7	5AQ327G3
65.4 29.7	5Q337G3	55.4 25.1	5AQ337G3
72.9 33.1	5Q347G3	62.9 28.5	5AQ347G3
80.4 36.5	5Q357G3	70.4 31.9	5AQ357G3
95.4 43.3	5Q367G3	85.4 38.7	5AQ367G3
110.4 50.1	5Q377G3	100.4 45.5	5AQ377G3
56.4 25.6	5Q417G3	46.4 21.0	5AQ417G3
63.1 28.6	5Q427G3	53.1 24.1	5AQ427G3
70.9 32.2	5Q437G3	60.9 27.6	5AQ437G3
82.1 37.2	5Q447G3	72.1 32.7	5AQ447G3
89.4 40.5	5Q457G3	79.4 36.0	5AQ457G3
106.4 48.3	5Q467G3	96.4 43.7	5AQ467G3
121.4 55.1	5Q477G3	111.4 50.5	5AQ477G3
56.4 25.6	5Q517G3	46.4 21.0	5AQ517G3
66.4 30.1	5Q527G3	56.4 25.6	5AQ527G3
76.4 34.7	5Q537G3	65.4 29.7	5AQ537G3
86.4 39.2	5Q547G3	78.4 35.6	5AQ547G3
96.4 43.7	5Q557G3	86.4 39.2	5AQ557G3
116.4 52.8	5Q567G3	106.4 48.3	5AQ567G3
136.4 61.9	5Q577G3	126.4 57.3	5AQ577G3



To attach shelves at right angles, one Intermediate “S” Hook Kit needed per shelf.

Intermediate “S” Hook Kit
Cat. No. Q9995Z

“S” Hook Kits — For individual shelves.



“S” Hook
Cat. No. M9995

MetroMax® Q “S” Hook Kit — {9.25}

Add on shelving using two posts instead of four. Includes one “S” hook. Two kits required per level when configuring units end-to-end.
Cat. No. M9995

Note: Collar/hole plug is designed for use with MetroMax i shelves only.



Intermediate “S” Hook Kit
Cat. No. Q9995Z

MetroMax® Q Intermediate “S” Hook Kit

Use when configuring MetroMax Q Starter and Add-On Units at right angles.

Cat. No. Q9995Z

Go mobile.

Add casters to any shelving unit to add versatility.

MetroMax® Stem Casters — {9.25}

For use with either polymer or steel stem caster posts.

- Promotes easy cleaning. Casters allow shelving units to be moved easily for access to floors and walls.
- Efficient Transport: Create a cart to efficiently move supplies throughout a facility or campus.

Polymer Stem Casters — {9.25}

Innovative polymer stem casters offer corrosion resistance and enhanced durability. Appropriate for all medium-duty mobile applications. Bumpers included.

- All-polymer horn, stainless axle, and hardware.
- 5" (127mm) diameter polyurethane, flat wheel tread.
- Sleeve style axle bearing and optional toe-operated brake mechanism



5PCX



5PCBX



5MPX

Wheel Diameter (in.) (mm)	Face (in.) (mm)	Load Rating (lbs.) (kg)	Type	Temperature Range (Continuous Usage) (Fahrenheit) (Celsius)	Approx. Pkd. Wt. (lbs.) (kg)	Cat. No.	Cat. No. Antimicrobial
5 127	1 1/4 32	300 135	Stem/Swivel	-20°-120° -29°-49°	2 0.9	5PCX	5PCXM
5 127	1 1/4 32	300 135	Stem/Brake	-20°-120° -29°-49°	2 0.9	5PCBX	5PCBXM
5 127	1 1/4 32	300 135	Stem/Rigid*	-20°-120° -29°-49°	2 0.9	5PCRX	—

*Note 1: Rigid casters are held in place by a connecting channel. When ordering, shelf width **must** be provided. Rigid connecting channel (aluminum) for 5PCRX caster: Cat. No. P18RC, P21RC, P24RC.

Note 2: Not suitable for cart wash and autoclave applications.

Standard Stem Casters — {9.25}

- Plated caster horns and hardware. Bumper included with each caster.
- Swivel, Swivel with Brakes, and Rigid Caster options available.

Wheel Diameter (in.) (mm)	Face (in.) (mm)	Load Rating (lbs.) (kg)	Type	Wheel Tread	Temperature Range (Continuous Usage) (Fahrenheit) (Celsius)	Approx. Pkd. Wt. (lbs.) (kg)	Cat. No.
5 127	1 1/4 32	200 90	Stem/Swivel	Resilient, Flat	-30°-160° -34°-71°	2 1/2 1.1	5MX
5 127	1 1/4 32	200 90	Stem/Brake	Resilient, Flat	-30°-160° -34°-71°	2 5/8 1.2	5MBX
5 127	1 1/4 32	200 90	Stem/Rigid*	Resilient, Flat	-30°-160° -34°-71°	3 1/2 1.5	5MRX
5 127	1 1/4 32	250 113	Stem/Swivel	High Modulus Donut	-40°-180° -40°-82°	2 1/2 1.1	5MDXA
5 127	1 1/4 32	250 113	Stem/Brake	High Modulus Donut	-40°-180° -40°-82°	2 5/8 1.2	5MDBXA
5 127	1 1/4 32	250 113	Stem/Rigid*	High Modulus Donut	-40°-180° -40°-82°	2 3/8 1.1	5MDRXA
5 127	1 1/4 32	300 135	Stem/Swivel	Polyurethane, Flat	-30°-180° -34°-82°	2 1/8 0.9	5MPX
5 127	1 1/4 32	300 135	Stem/Brake	Polyurethane, Flat	-30°-180° -34°-82°	2 1/4 1	5MPBX
5 127	1 1/4 32	300 135	Stem/Rigid*	Polyurethane, Flat	-30°-180° -34°-82°	2 0.9	5MPRX

*Note: Rigid casters are held in place by a connecting channel. When ordering, shelf width **must** be provided. Rigid connecting channel (stainless steel): Cat. No. 18RS, 21RS, or 24RS.

Stainless Steel Cart-Washable Stem Casters — {9.25}

- Stainless horn, axle, and stem with sealed bearings. Bumper included with each caster.

Wheel Diameter (in.) (mm)	Face (in.) (mm)	Load Rating (lbs.) (kg)	Type	Wheel Tread	Temperature Range (Continuous Usage) (Fahrenheit) (Celsius)	Approx. Pkd. Wt. (lbs.) (kg)	Cat. No.
5 127	1 1/4 32	300 135	Stem/Swivel	Polyurethane, Flat	-30°-180° -34°-82°	2 1/8 0.9	5MPXGSA
5 127	1 1/4 32	300 135	Stem/Brake	Polyurethane, Flat	-30°-180° -34°-82°	2 1/4 1	5MPBXGSA
5 127	1 1/4 32	300 135	Stem/Rigid*	Polyurethane, Flat	-30°-180° -34°-82°	2 0.9	5MPRXGSA

*Note: Rigid casters are held in place by a connecting channel. When ordering, shelf width **must** be provided. Rigid connecting channel (stainless steel): Cat. No. 18RS, 21RS, or 24RS.

Replacement Bumper — tri-lobal polymer or steel post.

Cat. No. M9992DBX



Rigid stem casters are often ordered two per unit for improved tracking and handling. Rigid caster channel are provided with each two rigid stem casters at no charge.



Interchangeable shelves, posts, and accessories provide increased storage efficiencies.

Handle it.

Adding stainless steel handles to shelving puts you in control.

- Use handles on mobile units to improve maneuverability and ergonomics.
- Handles are compatible with MetroMax® i, MetroMax® 4, and MetroMax® Q units.
- Corrosion proof Type 304 stainless steel construction offers long lasting performance.



Tri-Lobal Adapters
Included with handles.

Tri-Lobal Adapter Replacements

Cat. No. MTLA
Bag of 4 assemblies

MTLA adapters are designed to work with MetroMax i, MetroMax 4, and MetroMax Q and are not compatible with original MetroMax.

Extended and Easy-Grip Handles are compatible with original MetroMax Q shelves.

Extended Handle — {9.25}

Fits Shelf Depth		Extension Depth (Post to Edge of Handle)		Approx. Pkd. Wt		i, 4, and Q Cat. No.
(in.)	(mm)	(in.)	(mm)	(lbs.)	(kg)	
18	457	4.5	113	2.5	1.1	MEH18S
24	610	4.5	113	2.8	1.3	MEH24S

NOTE: Stainless steel fasteners are provided with each handle to secure the handle to the post for heavier duty applications



Easy-Grip Handle — {9.25}

Fits Shelf Depth		Extension Depth (Post to Edge of Handle)		Approx. Pkd. Wt		i, 4, and Q Cat. No.
(in.)	(mm)	(in.)	(mm)	(lbs.)	(kg)	
18	457	6	151	2.5	1.1	MERGH18S
24	610	6	151	3.0	1.4	MERGH24S

NOTE: Stainless steel fasteners are provided with each handle to secure the handle to the post for heavier duty applications





MetroMax® i
4-Tier with Open Grid
or Solid Shelves



MetroMax® i
5-Tier with Solid Bottom Shelf

MetroMax® i — Stem Caster Carts — {9.13}

- Corrosion proof shelves and posts; removable polymer mats.
- 4-Tier Units consist of four shelves, MX63UP posts 63" (1600mm), wedge connectors and choice of resilient rubber or polyurethane casters.
- 5-Tier Units consist of 5 shelves (4 open grid, 1 MetroMax i solid), 74" (1880mm) posts, wedge connectors, and polyurethane casters.
- Weight Capacity of cart: models with resilient rubber casters: 600 lbs. (272kg); models with polyurethane casters: 900 lbs. (408kg)



4-Tier Open Grid Mats

— Unit Height 67 5/16 (1710mm)

Nominal Width/Length (in.)	Nominal Width/Length (mm)	Approx. Pkd. Wt.		Cat. No. 2-Swivel, 2-Brake Resilient Rubber Casters	Cat. No. 2-Swivel, 2-Brake Polyurethane Casters
		(lbs.)	(kg)		
18x36	457x914	74	33	X336BGX3	X336EGX3
18x48	457x1219	86	38	X356BGX3	X356EGX3
18x60	457x1524	98	44	X366BGX3	X366EGX3
24x36	610x914	82	37	X536BGX3	X536EGX3
24x48	610x1219	98	44	X556BGX3	X556EGX3
24x60	610x1524	114	51	X566BGX3	X566EGX3

Solid Mats

Unit Height 67 5/16 (1710mm)

Approx. Pkd. Wt. (lbs.)	(kg)	Cat. No. 2-Swivel, 2-Brake Polyurethane Casters
106	48	X356EFX3
118	53	X366EFX3
102	46	X536EFX3
118	53	X556EFX3
134	60	X566EFX3

5-Tier Solid Bottom

Unit Height 79 5/16 (2015mm)

Approx. Pkd. Wt. (lbs.)	(kg)	Cat. No. 2-Swivel, 2-Brake Polyurethane Casters
109	49	5X357EGX3
121	55	5X367EGX3
102	46	5X537EGX3
123	56	5X557EGX3
141	63	5X567EGX3



MetroMax® 4
5-Tier with Open Grid and
Bottom Solid Shelf



MetroMax® 4
4-Tier with Open Grid Shelves

MetroMax® 4 — Stem Caster Carts — {9.15}

- Corrosion proof shelves and posts; removable polymer mats.
- 4-Tier Units consist of four shelves, MX63UP posts 63" (1600mm), wedge connectors and polyurethane casters with polymer horns.
- Weight Capacity of cart: models with polyurethane casters: 750 lbs. (340kg)



4-Tier Open Grid Mats

Unit Height 67 5/16 (1710mm)

Nominal Width/Length (in.)	Nominal Width/Length (mm)	Approx. Pkd. Wt.		Cat. No. 2-Swivel, 2-Brake Polyurethane Casters
		(lbs.)	(kg)	
18x36	457x914	50.6	22.9	X336PG4
18x48	457x1219	58.3	26.5	X356PG4
18x60	457x1524	66.6	30.2	X366PG4
24x36	610x914	57.2	25.9	X536PG4
24x48	610x1219	67.6	30.7	X556PG4
24x60	610x1524	77.2	35.0	X566PG4

5-Tier w/ Solid Bottom

Unit Height 79 5/16 (2015mm)

Approx. Pkd. Wt. (lbs.)	(kg)	Cat. No. 2-Swivel, 2-Brake Polyurethane Casters
70.7	32.1	5X357PG4
81.0	36.8	5X367PG4
69.3	31.4	5X537PG4
82.3	37.3	5X557PG4
94.3	42.8	5X567PG4



MetroMax® Q
4-Tier with Open Grid
(5-Tier available)

MetroMax® Q — Stem Caster Cart, Open Grid Shelves — {9.14}

- Quick adjust shelves with removable polymer shelf mats.
- 4-Tier Units consist of four open grid shelves, MQ63UPE posts 63" (1600mm), wedge connectors, and choice of resilient rubber or polyurethane casters.
- 5-Tier Units consist of 5 shelves, 74" (1880mm) posts, wedge connectors, and choice of resilient rubber or polyurethane casters.
- Weight Capacity of cart: models with resilient rubber casters: 600 lbs. (272kg); models with polyurethane casters: 900 lbs. (408kg)



4-Tier Open Grid Mats — Unit Height 67 5/16 (1710mm)

Nominal Width/Length (in.) (mm)	Approx. Pkd. Wt. (lbs.) (kg)	Cat. No. 2-Swivel, 2-Brake Resilient Rubber Casters	Cat. No. 2-Swivel, 2-Brake Polyurethane Casters
18x36 457x914	68 31	Q336BG3	Q336EG3
18x48 457x1219	84 38	Q356BG3	Q356EG3
18x60 457x1524	100 45	Q366BG3	Q366EG3
21x36 530x914	74 34	Q436BG3	Q436EG3
21x48 530x1219	90 41	Q456BG3	Q456EG3
21x60 530x1524	106 48	Q466BG3	Q466EG3
24x36 610x914	80 36	Q536BG3	Q536EG3
24x48 610x1219	96 44	Q556BG3	Q556EG3
24x60 610x1524	112 51	Q566BG3	Q566EG3

5-Tier Open Grid Mats Unit Height 79 7/16 (2015mm)

Approx. Pkd. Wt. (lbs.) (kg)	Cat. No. 2-Swivel, 2-Brake Polyurethane Casters
85 39	5Q337EG3
111 50	5Q357EG3
123 56	5Q367EG3
- -	-
- -	-
104 47	5Q537EG3
125 57	5Q557EG3
144 65	5Q567EG3



Solid bottom shelf and 5PCX/5PCBX casters

MetroMax® i — Utility Carts

- Corrosion proof shelves, posts, and Type 304 stainless steel handle.
- Corrosion resistant 5PCX casters with 5" (127mm) polyurethane wheels, polymer horns, and stainless steel axles.
- 39 1/4" (997mm) tall. Weight capacity of cart: 900 lbs. (408kg) evenly distributed.

Nominal Width/Length (in.) (mm)	Actual Width/Length (in.) (mm)	Description	Approx. Pkd. Wt. (lbs.) (kg)	Cat. No.
18x30 457x760	20 5/16 x 34 1/2 516 x 876	2-shelf	35.5 15.8	MXUC1830G-25
24x36 610x914	26 5/16 x 40 1/2 668 x 1029	2-shelf	46.0 20.5	MXUC2436G-25
18x30 457x760	20 5/16 x 34 1/2 516 x 876	3-shelf	46.0 20.5	MXUC1830G-35
24x36 610x914	26 5/16 x 40 1/2 668 x 1029	3-shelf	61.5 27.5	MXUC2436G-35



MetroMax® Q — Utility Carts

- Quick adjust corrosion resistant shelves and posts.
- Corrosion proof Type 304 stainless steel handle.
- Includes four 5MPX casters with 5" (127mm) polyurethane wheels.
- 39 1/4" (997mm) tall. Weight capacity of cart: 900 lbs. (408kg) evenly distributed.

Nominal Width/Length (in.) (mm)	Actual Width/Length (in.) (mm)	Description	Approx. Pkd. Wt. (lbs.) (kg)	Cat. No.
18x30 457x760	20 5/16 x 34 1/2 516 x 876	2-shelf	35.5 15.8	MQUC1830G-25
24x36 610x914	26 5/16 x 40 1/2 668 x 1029	2-shelf	46.0 20.5	MQUC2436G-25
18x30 457x760	20 5/16 x 34 1/2 516 x 876	3-shelf	46.0 20.5	MQUC1830G-35
24x36 610x914	26 5/16 x 40 1/2 668 x 1029	3-shelf	61.5 27.5	MQUC2436G-35





Organize.

Organize supplies to improve operational efficiencies.

- Well-organized storage results in fewer expired supplies and less waste.
- Innovative shelf and accessory designs have smooth surfaces that protect vacuum sealed and other packaged items from damage.
- Flexible compartments help sort supplies for faster access and maximize the use of storage space.

A Dividers **B Ledges** **C Enclosure Panels** **D Metro Totes** **E Metro Bins**



Flexible Compartments

Dividers and Ledges can be used to create flexible compartments that most efficiently use available storage space. When combined with open grid shelves this minimizes dust accumulation.

Bins offer removable compartmentalized storage for easy access or as part of an exchange system. See page 72 for Bin options.



8" (203mm) Shelf Dividers — Standard Duty — {9.25}

- Use to create organized compartments or to simply separate shelf contents.
- Easily repositioned on grid and solid shelves.
- Corrosion proof: Polymer (High-Density Polypropylene).
- Three-piece design — Ships assembled.

Nominal Length (in.)	(mm)	i	4	Q
		Cat. No.	Cat. No.	Cat. No.
18	457	MXD18-8	MAX4-D18-8	MQD18-8
24	610	MXD24-8	MAX4-D24-8	MQD24-8

*Note: Can be retrofitted to original MetroMax and MetroMax Q.



Universal 8" (203mm) Shelf Dividers — Light Duty, for open grid shelves — {9.25}

- For use with grid shelves (MetroMax i, MetroMax 4, MetroMax Q, and Super Erecta Pro), Super Erecta wire shelves, and Super Adjustable wire shelves.
- Easiest divider to install.
- Maximum flexibility: Can be repositioned along the entire shelf.
- Each divider includes a panel and two clips to connect to any open grid or wire shelf. Does not attach to solid shelves.
- Corrosion proof.

Nominal Length (in.)	(mm)	Fits Shelf Depth	Approx Pkd. Wt.		i, 4, and Q
			(lbs.)	(kg)	Cat. No.
18	457	18", 21" (457, 530mm)	1.3	0.6	MUD18-8
24	610	24" (610mm)	1.6	0.7	MUD24-8

*Note: Can be retrofitted to original MetroMax and MetroMax Q.
Additional clips: Cat. No **DCLIP**, 2 per bag.

Shelf-to-Shelf Dividers — {9.25}

- Full height dividers efficiently compartmentalize the space between two shelves.
- Smooth surfaces protect packaged items from damage.
- Corrosion proof.
- Compatible with open grid polymer shelves, Super Erecta wire shelves, and Super Adjustable wire shelves. Does not work with solid shelves.

Fits Shelf Depth		Nominal Height	Approx. Pkd. Wt.		i, 4, and Q Cat. No.
(in.)	(mm)		(in.)	(mm)	
18, 21	457, 530	16 406	2.3	1.0	MD18-16
18, 21	457, 530	20 508	2.5	1.1	MD18-20
18, 21	457, 530	24 610	3.8	1.7	MD18-24
24	610	16 406	2.8	1.2	MD24-16
24	610	20 508	3.0	1.3	MD24-20
24	610	24 610	4.4	2.0	MD24-24

*Note: Can be retrofitted to original MetroMax and MetroMax Q shelves.
 *Note: -16 parts have three panels, -20 parts have four panels, -24 parts have five panels.



2" (51mm) Stackable Shelf Ledges — {9.25}

- Prevent items from falling off shelves.
- Snap on and off quickly. Easily stacked to contain larger items.
- Corrosion proof: Polymer (High-Density Polypropylene) and Type 304 stainless steel.
- Ships assembled.

Nominal Length		Type	i	4	Q
(in.)	(mm)		Cat. No.	Cat. No.	Cat. No.
18	457	Side	MXLS18-2S	MAX4-LS18-2S	MQLS18-2S
21	530	Side	—	MAX4-LS21-2S	MQLS21-2S
24	610	Side	MXLS24-2S	MAX4-LS24-2S	MQLS24-2S
24	610	Back	MXL24-2S	MAX4-L24-2S	MQL24-2S
30	760	Back	MXL30-2S	MAX4-L30-2S	MQL30-2S
36	914	Back	MXL36-2S	MAX4-L36-2S	MQL36-2S
42	1066	Back	MXL42-2S	MAX4-L42-2S	MQL42-2S
48	1219	Back	MXL48-2S	MAX4-L48-2S	MQL48-2S
54	1370	Back	MXL54-2S	MAX4-L54-2S	MQL54-2S
60	1524	Back	MXL60-2S	MAX4-L60-2S	MQL60-2S
72	1829	Back	MXL72-2S	—	MQL72-2S

*Note: MetroMax i wire ledges can be retrofitted to original MetroMax.
 *Note: MetroMax Q wire ledges (MQ-) cannot be retrofitted to original MetroMax Q.



4" (102mm) Solid Clear Stackable Shelf Ledges — {9.26}

- Solid design helps contain small items.
- Clear plastic allows light penetration and visible access to supplies.
- Corrosion proof.
- Ships assembled.

Nominal Length		Type	Approx. Pkd. Wt.		i	4
(in.)	(mm)		(lbs.)	(kg)	Cat. No.	Cat. No.
18	457	Side	0.50	0.2	MXLS18-4P	MAX4-LS18-4P
24	610	Side	0.50	0.2	MXLS24-4P	MAX4-LS24-4P
24	610	Back	0.50	0.2	MXL24-4P	MAX4-L24-4P
36	914	Back	1.00	0.4	MXL36-4P	MAX4-L36-4P
48	1219	Back	1.25	0.6	MXL48-4P	MAX4-L48-4P
60	1524	Back	1.75	0.8	MXL60-4P	MAX4-L60-4P

Note: Not suitable for cart-wash applications.





Contain it.

Efficiently enclose and contain with Enclosure Panels.

Enclosure Panels — {9.25}

- An efficient way of enclosing the sides and back of all shelves in a unit to contain stored contents.
- Slot opening: 3" W x 3⁷/₈" H.
- Designed to work with MetroMax® i, MetroMax® 4, and MetroMax® Q shelves. Mounting clips included.

Use shelf to shelf dividers with enclosure panels to create full height compartments to organize bulky, hard-to-handle supplies.



Enclosure Panel

Actual Width/Height (in., mm)	Post Height (in., mm)	For use with Shelf Width (in., mm)	Approx. Pkd. Wt. (lbs., kg)	i, 4, and Q Cat. No.
12 ³ / ₈ x 51 ¹ / ₄ 315 x 1300	54 1370	18 457	6 ¹ / ₄ 2.8	MEP35E
12 ³ / ₈ x 59 ¹ / ₄ 315 x 1505	63 1600	18 457	7 3.2	MEP36E
12 ³ / ₈ x 71 ¹ / ₄ 315 x 1810	74 1880	18 457	8 ³ / ₄ 4.0	MEP37E
18 ³ / ₈ x 51 ¹ / ₄ 467 x 1300	54 1370	21, 24 530, 610	9 4.1	MEP55E
18 ³ / ₈ x 59 ¹ / ₄ 467 x 1505	63 1600	21, 24 530, 610	10 ¹ / ₄ 4.7	MEP56E
18 ³ / ₈ x 71 ¹ / ₄ 467 x 1810	74 1880	21, 24 530, 610	11 ³ / ₄ 5.3	MEP57E

*Note: Can be retrofitted to original MetroMax and MetroMax Q shelving.

Panels Required to Enclose Both Ends of the Shelving Unit or Cart

Post Height	Shelf Width		
	18" (457mm)	21" (530mm)	24" (610mm)
54" (1370mm)	(2) MEP35E	(2) MEP55E	(2) MEP55E
63" (1600mm)	(2) MEP36E	(2) MEP56E	(2) MEP56E
74" (1880mm)	(2) MEP37E	(2) MEP57E	(2) MEP57E

Configuration Notes

1. Handles and enclosure panels can be used on the same end of the cart. Please note the following details: 21" (530mm) wide units: use the 12³/₈" (315mm) wide panel on the same end as the handle.
2. Top-Track: When using on the ends of a Top-Track mobile unit the enclosure panel must be mounted so that it does not interfere with the overhead tracks. Mobile posts on Top-Track are 74" (1880mm). The standard panels for a 63" post are recommended.

Panels Required to Enclose Back of Shelving Unit or Cart

Post Height	Shelf Length						
	30" (760mm)	36" (914mm)	42" (1066mm)	48" (1219mm)	54" (1370mm)	60" (1524mm)	72" (1825mm)
54" (1370mm)	(2) MEP35E	(1) MEP35E (1) MEP55E	(2) MEP55E	(2) MEP35E (1) MEP55E	(1) MEP35E (2) MEP55E	(3) MEP55E	(1) MEP35E (3) MEP55E
63" (1600mm)	(2) MEP36E	(1) MEP36E (1) MEP56E	(2) MEP56E	(2) MEP36E (1) MEP56E	(1) MEP36E (2) MEP56E	(3) MEP56E	(1) MEP36E (3) MEP56E
74" (1880mm)	(2) MEP37E	(1) MEP37E (1) MEP57E	(2) MEP57E	(2) MEP37E (1) MEP57E	(1) MEP37E (2) MEP57E	(3) MEP57E	(1) MEP37E (3) MEP57E



MetroMax® i Mounting Clip Replacements

Bag of 8
Cat. No. RPMX3-RODTAB



MetroMax® 4 Mounting Clip Replacements

Bag of 8
Cat. No. RPMX4-RODTAB

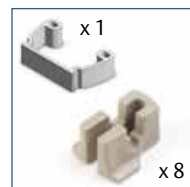

MetroMax® Q Mounting and Bottom Adapter Clip Replacements

Bag of 8
Cat. No. RPMQ3-RODTAB

Label Holders

- Plastic holders snap onto shelf edge to accommodate 1" (25mm) tall adhesive label. Label not included.
- i, 4, and Q versions available.
- Optional label holder covers exist for MetroMax Q models. Cover snaps onto the label holder to hold a non-adhesive label in place or to protect any label from dirt and moisture.

MetroMax® i Label Holder — {9.25}

Designed to accept label cards or adhesive labels. Slot measures approximately 1 1/4" (32mm).

Actual Length		Fits Shelf Length		Approx. Pkd. Wt.		Cat. No. Label Holder
(in.)	(mm)	(in.)	(mm)	(lbs.)	(kg)	
4 1/2	114	All		.03	.01	9989PX
11 9/32	285	24	610	.14	.06	9989X1
23 9/32	590	36	914	.30	.13	9989X3
35 9/32	895	48	1219	.40	.18	9989X5

MetroMax® Q Label Holder — {9.25}

Designed to accept label cards or adhesive labels. Slot measures approximately 1 1/4" (32mm).

Actual Length		Fits Shelf Length		Approx. Pkd. Wt.		Cat. No. Label Holder
(in.)	(mm)	(in.)	(mm)	(lbs.)	(kg)	
4	102	All		.03	.01	MQ04LH
15 7/16	392	24	610	.14	.06	MQ24LH
27 7/16	697	36	914	.30	.13	MQ36LH
39 7/16	1002	48	1219	.40	.18	MQ48LH
51 7/16	1307	60	1524	.50	.22	MQ60LH
63 7/16	1611	72	1825	.60	.27	MQ72LH

MetroMax® 4 Label Holder — {9.25}

Designed to accept label cards or adhesive labels. Slot measures approximately 1" (25mm).

Actual Length		Fits Shelf	Approx. Pkd. Wt.		4
(in.)	(mm)	(in.) (mm)	(lbs.)	(kg)	Cat.No.
4	102	All	.03	.01	MAX4-9989PX

Color Shelf Markers — {9.25}

- Attach easily to shelf for content identification.
- Use to assign color coding to individual shelf levels, shelving units, carts, or storage areas.
- i and Q versions available.
- 6" (152mm) length.

Shelf Marker Color	Approx. Pkd. Wt.		i	Q
	(lbs.)	(kg)	Cat. No.	Cat. No.
Blue	0.05	0.02	CSM6-BX	CSM6-BQ
Green	0.05	0.02	CSM6-GX	CSM6-GQ
Red	0.05	0.02	CSM6-RX	CSM6-RQ
Tan	0.05	0.02	CSM6-TX	CSM6-TQ
White	0.05	0.02	CSM6-WX	CSM6-WQ
Yellow	0.05	0.02	CSM6-YX	CSM6-YQ
Gray	0.05	0.02	CSM6-GRX	CSM6-GRQ

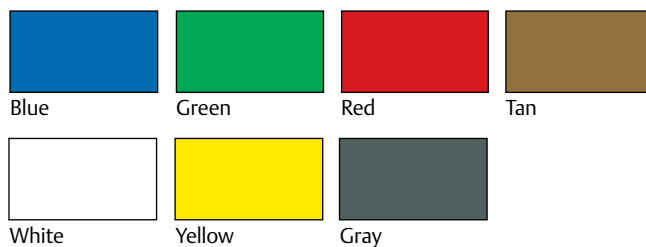

MetroMax® i Label Holder



MetroMax® Q Label Holder



MetroMax® 4 Label Holder



MetroMax® i Color Shelf Marker

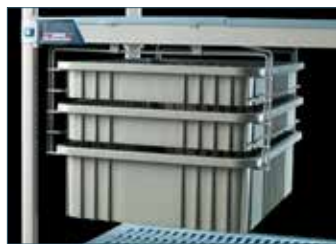

Totes sold separately

Super Slide — {9.25}

- Designed to fit a 24" (610mm) wide shelf.
- Easily attaches to the shelf frame (under the mats) and is sized to hold 3", 5", 6", and 8" (76, 127, 152, 203mm) tall tote boxes (sold separately).
- MetroMax® i and MetroMax 4 models available.
- Corrosion resistant taupe epoxy finish with Microban antimicrobial product protection.

Width		Length		Height		Approx. Pkd. Wt.		i	4
(in.)	(mm)	(in.)	(mm)	(in.)	(mm)	(lbs.)	(kg)	Cat. No.	Cat. No.
20.4	520	21.6	550	10.3	260	5.3	2	MXSS2E	MAX4-SS2E



Adjustable Slides — {9.25}

- Slides can be adjusted left to right to accommodate a variety of pan, tray, and container sizes.
- MetroMax® i and Q models available.
- Corrosion resistant taupe epoxy finish with Microban antimicrobial product protection.
- Shelves must be spaced 20" (508mm) apart.
- Can be used in conjunction with 20" (508mm) tall shelf-to-shelf dividers.

Fits Shelf Width		Type	Approx. Pkd. Wt.		i	Q
(in.)	(mm)		(lbs.)	(kg)	Cat. No.	Cat. No.
24	610	Adjustable	12 ³ / ₄	6	MX24SE	MQ24SE



Can Rack System — {9.25}

- Front loading, front dispensing can rack holds eight #10 cans or twelve #5 cans.
- Tough, corrosion resistant taupe epoxy finish with Microban antimicrobial product protection.
- Designed to fit a 24" (610mm) wide shelf.
- Mounts on any MetroMax® i or MetroMax Q shelf.

Width/Length/Height		Approx. Pkd. Wt.		i and Q
(in.)	(mm)	(lbs.)	(kg)	Cat. No.
7 ⁷ / ₈	25 ⁵ / ₁₆ x 15	200	643 x 381	10 4.5 CR24E

Storage Level Frames — {9.25}

- Open four sided frames accommodate drop-in accessories including wire baskets and stainless drying racks.
- Includes corrosion proof MetroMax i frame and a bag of wedges.
- Can be mounted on MetroMax i, MetroMax 4, and MetroMax Q shelving units.

Nominal Exterior Length		Frame Interior Width/Length		Approx. Pkd. Wt.		Cat. No.	
Width (in.) (mm)	(in.) (mm)	(in.) (mm)	(in.) (mm)	(lbs.) (kg)	(lbs.) (kg)		
18	457	36	914	18x32	457x810	7 3.2	M4F1836
24	610	24	610	24x20	610x510	7½ 3.4	M4F2424
24	610	36	914	24x32	610x810	11¼ 5.1	M4F2436
24	610	42	1060	24x38	610x965	13¾ 6.0	M4F2442
24	610	48	1220	24x44	610x1120	15 6.8	M4F2448
24	610	60	1524	24x56	610x1370	18¾ 8.5	M4F2460

Note: Any MetroMax i shelf can be converted to an open storage level frame. Simply remove the shelf mats and center beam to create an open frame.

Wire Baskets — {9.25}

- Conveniently hold small items.
- 9" (229mm) deep.
- Built in storage handles allow easy removal.
- Corrosion resistant taupe epoxy finish.
- Weight Capacity: 50 lbs. (23kg)
- Installs flat. Mounts to a MetroMax i storage level frame. Retrofits to a MetroMax i shelf or MetroMax 4 shelf.

Width		Length		Approx. Pkd. Wt.		Cat. No.
(in.) (mm)	(in.) (mm)	(in.) (mm)	(in.) (mm)	(lbs.) (kg)	(lbs.) (kg)	
24	610	16	406	10	4.5	MB2416XE
24	610	22	560	12	5.5	MB2422XE

NOTE: Wire baskets can be retrofitted to MetroMax i or MetroMax 4 shelves.

MetroMax i: Remove the mats center beams and drop in the baskets.

MetroMax 4: Remove the mats and drop in the baskets.

Wire baskets can complement a MetroMax 4 shelf. If the requirement is to completely fill out the space with baskets, use a MetroMax i storage level frame.



MetroMax i Configuration

QTY. to fill out shelf frame.

FRAME	B2416XE	B2422XE
M4F2436	2	
M4F2442	1	1
M4F2448		2
M4F2460	2	1

MetroMax 4 Configuration

SHELF	B2416XE	B2422XE
MAX4-2436G		1
MAX4-2436G	2	
MAX4-2436G	1	1
MAX4-2436G	3	

NOTE: Remove the shelf mats to install the drop in basket.



Glassware Handling Basket

Vinyl coated. Fits 18 x 36" (457 x 914mm) MetroMax i frame.

Cat. No. **GWBSKT36**

See Spec Sheet 52.01 for detail.

Not NSF listed.



3-Sided frames

- 1" (25mm) x 1½" (38mm) structural steel tubing. Includes tri-lobal adapters to attach to posts. (Replacement adapters: Cat. No. **MTLA** bag of 4)
- Corrosion resistant taupe epoxy finish.
- Use when configuring work tables or as a 3-sided ledge to contain bulky items.

Nominal Width		Nominal Length		Approx. Pkd. Wt.		i, 4, and Q Cat. No.
(in.) (mm)	(in.) (mm)	(in.) (mm)	(in.) (mm)	(lbs.) (kg)	(lbs.) (kg)	
24	610	24	610	12	5.4	M3TF2424E
24	610	30	760	13	5.7	M3TF2430E
24	610	36	914	14	6.4	M3TF2436E
24	610	48	1220	18	8.2	M3TF2448E
24	610	60	1524	20	9.1	M3TF2460E



Dry it.



PR48X3

MetroMax® i Drying Rack Unit — {9.31}

- Allows superior air circulation and fast drying of trays, pans, lids, pots and all pot sink items.
- Promotes food safety by eliminating moisture. Offers an efficient organized drying area.
- Mobile models come equipped with corrosion resistant polymer casters: (2) swivel 5PCX and (2) swivel/brake 5PCBX.
- Shelves, posts, and tray drying racks include Microban antimicrobial product protection
- NSF Listed

Models with two drop-ins (Cat. No. DR48S) and one cutting board/tray drying rack (Cat. No. MTR2448XE)

Configuration	Nominal Width		Nominal Length		Height		Pkd. Wt.		i Cat. No.
	(in.)	(mm)	(in.)	(mm)	(in.)	(mm)	(lbs.)	(kg)	
Stationary	24	610	48	1219	75½	1917	106	49	PR48X3
Mobile*	24	610	48	1219	68	1727	106	49	PR48VX3

*Note: Includes two 5PCX swivel casters and two 5PCBX swivel casters with brakes.



PR48VX4

Models with four cutting board/tray drying racks: (2) MTR2448XE and (2) MTR2448XEA

This rack is perfect for steam and bun pans, and one unit can hold up to 96 pans.

Configuration	Nominal Width		Nominal Length		Height		Pkd. Wt.		i Cat. No.
	(in.)	(mm)	(in.)	(mm)	(in.)	(mm)	(lbs.)	(kg)	
Stationary	24	610	48	1219	75½	1917	106	49	PR48X4
Mobile*	24	610	48	1219	68	1727	106	49	PR48VX4

*Note: Includes two 5PCX swivel casters and two 5PCBX swivel casters with brakes.

Cutting Board and Tray Drying Rack — {9.25} {9.31}

- Rack is compatible with MetroMax i, MetroMax Q, Super Erecta Pro, Super Adjustable, and Super Erecta wire shelves.
- Promotes safe air drying of cutting boards, trays and steam pans.
- 1 1/8" (28mm) and 3" (76mm) slide spacing available.



Fits Shelf	Upright Spacing	Upright Height	Tray Capacity	Pkd. Wt.		i and Q Cat. No.
				(in.)	(mm)	
24x36 610x914	1 1/8 28	6 150	24	13.5	6.1	MTR2436XE
24x48 610x1219	1 1/8 28	6 150	34	18.0	8.2	MTR2448XE
24x60 610x1524	1 1/8 28	6 150	42	22.5	10.2	MTR2460XE
24x36 610x914	3 76	6 150	10	9.8	4.4	MTR2436XEA
24x48 610x1219	3 76	6 150	14	13	5.9	MTR2448XEA
24x60 610x1524	3 76	6 150	17	16.3	7.4	MTR2460XEA

*Note: Can be retrofitted to original MetroMax and MetroMax Q.

Stainless Steel Drop-in Racks — {9.25} {9.31}

- Open wire design provides air flow to safely dry pots, pans, and containers
- Are installed over an open MetroMax® i frame and center beam.
- Can be retrofitted to existing MetroMax® i shelves. Simply remove the mats and drop in the stainless drying rack.

How to order: (1) drop-in rack, (1) 4-sided shelf frame, (1) replacement center beam

Width		Length		Height		Wire Spacing		Approx. Pkd. Wt.		Cat. No.
(in.)	(mm)	(in.)	(mm)	(in.)	(mm)	(in.)	(mm)	(lbs.)	(kg)	
24	610	33 ⁷ / ₈	854	5 ¹ / ₄	133	³ / ₄	19	9	4.1	DR36S
24	610	45 ⁷ / ₈	1156	5 ¹ / ₄	133	³ / ₄	19	12	5.4	DR48S
24	610	57 ⁷ / ₈	1458	5 ¹ / ₄	133	³ / ₄	19	15	6.8	DR60S

Note: Any MetroMax i shelf can be converted to an open storage level frame. Simply remove the shelf mats and center beam to create an open frame.



Shelf Frames — See page 27.

Replacement Center Beam

Fits Shelf Frame		Cat. No.
(in.)	(mm)	
24 x 36	610 x 914	RPMX36-CBEAM
24 x 48	610 x 1219	RPMX48-CBEAM
24 x 60	610 x 1524	RPMX60-CBEAM

MetroMax® i Sloped Basket Cart — {30.20}

- Ideal for compartmentalizing bulky or odd-shaped items.
- Baskets have a taupe epoxy finish with Microban antimicrobial product protection.
Note: Baskets are not suitable for walk-in coolers.
- Baskets have semi open front for easy access.
- Baskets can mount flat or at a 10° angle for stock rotation
- Dividers adjust horizontally

Description	Height/Width/Length		Total Baskets Per Cart	Casters	Cat. No.
	(in.)	(mm)			
Open Cart	60x24x24	1524x610x610	4	*	MXIV1
Open Cart with Top Shelf	69x24x24	1753x610x610	4	*	MXIV2
Open Cart	60x24x42	1524x610x1066	8	†	MXIV4
Open Cart with Top Shelf	69x24x42	1753x610x1066	8	†	MXIV5
Open Cart	60x24x60	1524x610x1524	12	†	MXIV6
Open Cart with Top Shelf	69x24x60	1753x610x1524	12	†	MXIV7

Note: Each basket sold with cart includes two dividers and a label holder.
 *Four 5" (127mm) polyurethane casters; two swivel, two with brakes.
 †5" (127mm) polyurethane casters with plated horns; casters on dolly frame; two swivel, one swivel with brake, and one rigid.



MXIV1

Accessories

Description	(in.)	(mm)	Cat. No.
Basket with Label Holder	18 ¹ / ₂ x24 ¹ / ₂ x10	470x622x254	IVB1
Divider	9	229	IVBD



IVB1
(shown with optional Divider)



**Superior
materials
and design
for every
application.**



Super Erecta Pro®
Super Adjustable Super Erecta®
and Super Erecta®
Erecta Shelf®
HD Super®

WIRE & SOLID SHELVING SOLUTIONS

Wire/Polymer Hybrid Shelving	32-35
Easy-Adjust Shelving & Carts	36-39
Wire Shelving, Carts & Trucks	40-49
Casters & Accessories for Wire Shelving	50-63
qwikSLOT Adjustable Shelving	65-71
Shelving Storage Bins	72-73
Solid Shelving & Accessories	74-76
Light-Duty Wire Shelving & Accessories	77
Heavy-Duty Solid Shelving & Accessories	78-79

Proven.

Genuine Metro Super Erecta®
The industry standard — innovated and reinnovated.

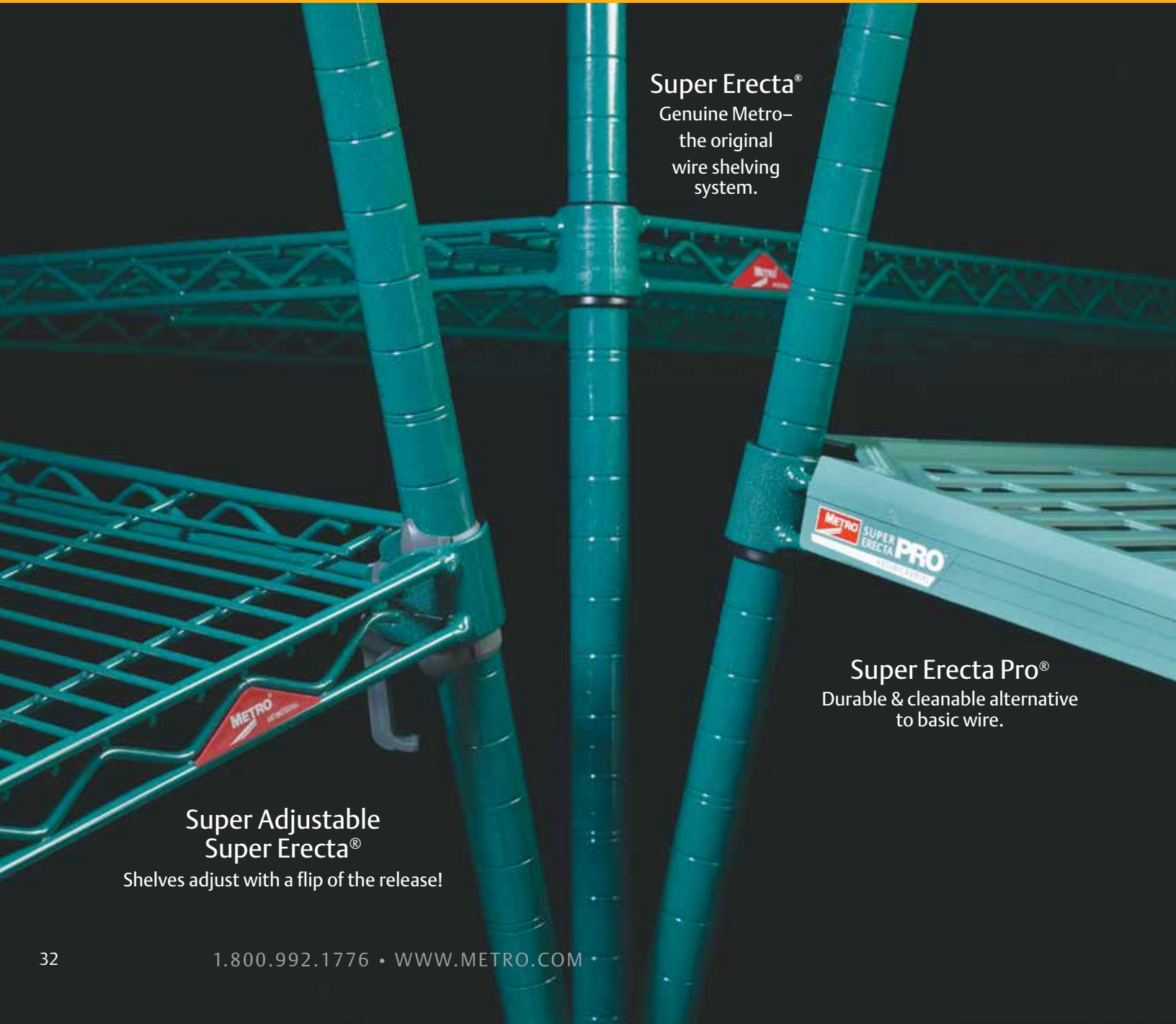

Super Erecta®
Genuine Metro—
the original
wire shelving
system.

Super Erecta Pro®
Durable & cleanable alternative
to basic wire.

Super Adjustable
Super Erecta®
Shelves adjust with a flip of the release!

Progress.



Epoxy coated Super Erecta-style frames with removable polymer shelf mats.

Stays cleaner between cleanings.

Polymer shelf mats and Metroseal 3 epoxy coated shelf frames and posts have built in Microban® antimicrobial product protection.



Super Erecta Pro™
Durable & cleanable.
The original — reinnovated.

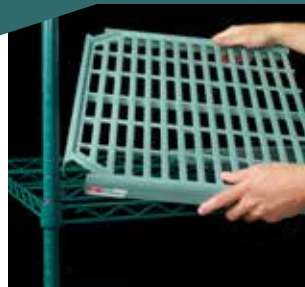

Easy to clean.

Lift-off mats can be easily removed and washed by hand or in a wash machine.

Prolonged durability.

Polymer shelf mats withstand daily abuse from containers and sharp edges. Robust design provides the strength and rigidity of Super Erecta...holds up to 800 lbs. (363kg) per shelf.



Interchangeable.

Super Erecta Pro shelves can be configured with traditional shelf and accessory options on the same unit for maximum flexibility.



Super Erecta Pro® Shelves — {10.80}

Packaging: Shelves are priced individually and packaged no more than 4 per carton except 60" (1524mm) and 72" (1829mm) lengths which are packaged no more than 2 per carton. Plastic split sleeves are included with each shelf.

Nominal Width/Length (in./mm)		Approx. Pkd. Wt. (lbs./kg)		Cat. No. Super Erecta Pro Metroseal 3
18x24	457x610	6.0	2.7	PR1824NK3
18x30	457x760	7.8	3.5	PR1830NK3
18x36	457x914	9.5	4.2	PR1836NK3
18x42	457x1060	11.3	5.0	PR1842NK3
18x48	457x1219	13.0	5.8	PR1848NK3
18x54	457x1372	14.8	6.6	PR1854NK3
18x60	457x1524	16.5	7.4	PR1860NK3
18x72	457x1829	19.8	8.8	PR1872NK3
21x24	530x610	8.0	3.6	PR2124NK3
21x30	530x760	9.5	4.2	PR2130NK3
21x36	530x914	11.3	5.0	PR2136NK3
21x42	530x1060	12.5	5.6	PR2142NK3
21x48	530x1219	14.3	6.4	PR2148NK3
21x54	530x1372	16.5	7.4	PR2154NK3
21x60	530x1524	18.3	8.1	PR2160NK3
21x72	530x1829	21.5	9.6	PR2172NK3
24x24	610x610	9.5	4.2	PR2424NK3
24x30	610x760	11.3	5.0	PR2430NK3
24x36	610x914	13.0	5.8	PR2436NK3
24x42	610x1060	14.0	6.3	PR2442NK3
24x48	610x1219	15.5	6.9	PR2448NK3
24x54	610x1372	18.3	8.1	PR2454NK3
24x60	610x1524	20.0	8.9	PR2460NK3
24x72	610x1829	23.3	10.4	PR2472NK3

Note: Each Super Erecta Pro™ shelf up to and including 48" (1219mm) long has a maximum weight capacity of 800 lbs. (363kg) evenly distributed. Shelves longer than 48" (1219mm) have a maximum weight capacity of 600 lbs. (272kg) evenly distributed.

Actual Dimensions: Width: Add 1/4" (6mm) to nominal size. Length: Subtract 1/4" (6mm) from nominal size.

Super Erecta Pro® Easy Order Kits

Kit includes four shelves and four 74.5" (1892mm) split posts. Ships in one box.

Nominal Width/Length (in./mm)	Approx. Pkd. Wt. (lbs./kg)	Cat. No. Super Erecta Pro Metroseal 3
18x36 457x914	58 26.3	EZPR1836NK3-4
18x48 457x1219	73 33.1	EZPR1848NK3-4
24x36 610x914	72 32.6	EZPR2436NK3-4
24x48 610x1219	83 37.6	EZPR2448NK3-4

Super Erecta with Metroseal 3™ — Standard Shelves

Nominal Width/Length (in./mm)		Approx. Pkd. Wt. (lbs./kg)		Cat. No. Super Adjustable Metroseal 3	Cat. No. Super Erecta Metroseal 3	Approx. Pkd. Wt. (lbs./kg)	Cat. No. Dunnage Shelf Metroseal 3
18x24	457x610	7	3.2	A1824NK3	1824NK3	14 6.3	1824DRK3
18x30	457x760	8	3.6	A1830NK3	1830NK3	18 8.1	1830DRK3
18x36	457x914	9.5	4.3	A1836NK3	1836NK3	21 9.4	1836DRK3
18x42	457x1060	11	5.0	A1842NK3	1842NK3	—	—
18x48	457x1219	12	5.4	A1848NK3	1848NK3	28 12.6	1848DRK3
18x54	457x1372	14.5	6.6	A1854NK3	1854NK3	—	—
18x60	457x1524	17	7.7	A1860NK3	1860NK3	34 15.3	1860DRK3
18x72	457x1829	20	9.1	A1872NK3	1872NK3	—	—
21x24	530x610	8	3.6	A2124NK3	2124NK3	—	—
21x30	530x760	9	4.1	A2130NK3	2130NK3	—	—
21x36	530x914	11	5.0	A2136NK3	2136NK3	—	—
21x42	530x1060	12	5.4	A2142NK3	2142NK3	—	—
21x48	530x1219	14	6.4	A2148NK3	2148NK3	—	—
21x54	530x1372	16	7.3	A2154NK3	2154NK3	—	—
21x60	530x1524	18	8.2	A2160NK3	2160NK3	—	—
21x72	530x1829	24	10.9	A2172NK3	2172NK3	—	—
24x24	610x610	9	4.1	A2424NK3	2424NK3	16 7.2	2424DRK3
24x30	610x760	11	5.0	A2430NK3	2430NK3	20 9.0	2430DRK3
24x36	610x914	13	5.9	A2436NK3	2436NK3	24 10.8	2436DRK3
24x42	610x1060	15	6.8	A2442NK3	2442NK3	—	—
24x48	610x1219	16	7.3	A2448NK3	2448NK3	30 13.5	2448DRK3
24x54	610x1372	19	8.6	A2454NK3	2454NK3	—	—
24x60	610x1524	21	9.5	A2460NK3	2460NK3	37 16.6	2460DRK3
24x72	610x1829	26	11.8	A2472NK3	2472NK3	—	—

Indicates antimicrobial product.

SiteSelect™ Posts — {10.80}

Stationary Super Erecta SiteSelect posts are fitted with adjustable leveling bolts to compensate for uneven surfaces. Mobile posts come without leveling bolt assembly to accommodate stem casters. Special length posts are available. See page 50 for stem caster options.



SiteSelect posts provide a visual guide for positioning and adjusting shelves, saving considerable time during assembly and adjustment. An easy-to-identify double groove, every 8" (203mm), offers a quick way to align all shelves.

Stationary Posts

Height (in.)	Height (mm)	Approx. Pkd. Wt.		Cat. No. Metroseal 3	Cat. No. Stainless
		(lbs.)	(kg)		
14 ¹ / ₂	370	1	0.5	13PK3	13PS
34 ¹ / ₂	875	2	0.9	33PK3	33PS
54 ⁹ / ₁₆	1385	3	1.4	54PK3	54PS
62 ⁹ / ₁₆	1590	3 ¹ / ₂	1.6	63PK3	63PS
74 ⁵ / ₈	1895	4	1.8	74PK3	74PS
86 ⁵ / ₈	2200	5	2.3	86PK3	86PS

Mobile Posts

Height (in.)	Height (mm)	Approx. Pkd. Wt.		Cat. No. Metroseal 3	Cat. No. Stainless
		(lbs.)	(kg)		
13 ³ / ₄	349	1	0.5	13UPK3	13UPS
33 ³ / ₄	857	2	0.9	33UPK3	33UPS
53 ¹³ / ₁₆	1366	3	1.4	54UPK3	54UPS
61 ¹³ / ₁₆	1570	3 ¹ / ₂	1.6	63UPK3	63UPS
69 ⁹ / ₄	1772	3.8	1.7	70UPK3	—
73 ⁷ / ₈	1876	4	1.8	74UPK3	74UPS
85 ⁷ / ₈	2181	5	2.3	86UPK3	86UPS

Accessories — {10.81}

Note: These accessories are designed to attach to a Super Erecta Pro Shelf. Accessories for basic Super Erecta wire shelves can be found on pages 55-63. For a complete list of compatible accessories for Super Erecta Pro shelves, please refer to spec sheet 10.81 for more information.

“S” Hooks

Eliminates the need for adjacent posts. Two required for each storage level.

Cat. No. Q9995Z

Standard Divider

- Corrosion proof

Nominal Length (in.)	(mm)	Fits Shelf Depth	Approx. Pkd. Wt.		Cat. No.
			(lbs.)	(kg)	
18	457	18", 21" (457, 530mm)	1.3	0.6	MQD18-8
24	610	24" (610mm)	1.6	0.7	MQD24-8

Shelf-to-Shelf Divider

- Connects between two shelves
- Corrosion proof

Nominal Height (in.)	(mm)	Compatible with Shelf Depths		Approx. Pkd. Wt.		Cat. No.
		(in.)	(mm)	(lbs.)	(kg)	
16	406	18, 21	457, 530	2.3	1.0	MD18-16
20	508	18, 21	457, 530	2.5	1.1	MD18-20
24	610	18, 21	457, 530	3.8	1.7	MD18-24
16	406	24	610	2.8	1.2	MD24-16
20	508	24	610	3.0	1.3	MD24-20
24	610	24	610	4.4	2.0	MD24-24

Color Shelf Marker

- 6" (152mm) Length
- Fits Super Erecta Pro Shelf
- Attach easily to shelf to identify contents stored.

Color	Length		Approx. Pkd. Wt.		Cat. No.
	(in.)	(mm)	(lbs.)	(kg)	
Blue	6	152	0.05	0.02	CSM6-BQ
Green	6	152	0.05	0.02	CSM6-GQ
Red	6	152	0.05	0.02	CSM6-RQ
Tan	6	152	0.05	0.02	CSM6-TQ
White	6	152	0.05	0.02	CSM6-WQ
Yellow	6	152	0.05	0.02	CSM6-YQ
Gray	6	152	0.05	0.02	CSM6-GRQ

Label Holders

- Fits Super Erecta Pro Shelf
- Plastic holders snap into place to accommodate 1" (25mm) tall adhesive label.

Cat. No. MQ04LH



Indicates antimicrobial product.

Reclaim Wasted Space.



Super Adjustable
Super Erecta® Shelving

Adjust and add shelves
quickly and easily
to reclaim wasted space.



Super Erecta

Easy “no-tool”
shelf adjustment

1" (25mm)
spacing minimizes
dead space

Efficient use of space
allows more storage
levels to be added.

Storage efficiency
can increase
by 25% or more



Super Adjustable
Super Erecta





SUPER ADJUSTABLE SUPER ERECTA® SHELVING

Super Adjustable Wire Shelves — {10.01a} {10.10a}

Packaging: Wire shelves are priced individually and packaged no more than 4 per carton except 60" (1524mm) and 72" (1829mm) lengths and 30" (760mm) and 36" (914mm) widths, which are packaged no more than 2 per carton. Plastic sleeves and wedges are included with each shelf.

Width/Length (in.)	(mm)	Approx. Pkd. Wt.		Cat. No. Chrome	Cat. No. Metroseal 3 with Microban*	Cat. No. Stainless
		(lbs.)	(kg)			
14x24	355x610	6	2.7	A1424NC	A1424NK3	A1424NS
14x30	355x760	7	3.2	A1430NC	A1430NK3	A1430NS
14x36	355x914	8	3.6	A1436NC	A1436NK3	A1436NS
14x42	355x1066	9½	4.3	A1442NC	A1442NK3	A1442NS
14x48	355x1219	10½	4.7	A1448NC	A1448NK3	A1448NS
14x60	355x1524	14	6.3	A1460NC	A1460NK3	A1460NS
14x72	355x1825	17	7.7	A1472NC	A1472NK3	A1472NS
18x24	457x610	7	3.2	A1824NC	A1824NK3	A1824NS
18x30	457x760	8	3.6	A1830NC	A1830NK3	A1830NS
18x36	457x914	9½	4.3	A1836NC	A1836NK3	A1836NS
18x42	457x1066	11	5.0	A1842NC	A1842NK3	A1842NS
18x48	457x1219	12	5.4	A1848NC	A1848NK3	A1848NS
18x54	457x1370	14½	6.6	A1854NC	A1854NK3	A1854NS
18x60	457x1524	17	7.7	A1860NC	A1860NK3	A1860NS
18x72	457x1829	20	9.1	A1872NC	A1872NK3	A1872NS
21x24	530x610	8	3.6	A2124NC	A2124NK3	A2124NS
21x30	530x760	9	4.1	A2130NC	A2130NK3	A2130NS
21x36	530x914	11	5.0	A2136NC	A2136NK3	A2136NS
21x42	530x1066	12	5.4	A2142NC	A2142NK3	A2142NS
21x48	530x1219	14	6.4	A2148NC	A2148NK3	A2148NS
21x54	530x1370	16	7.3	A2154NC	A2154NK3	A2154NS
21x60	530x1524	18	8.2	A2160NC	A2160NK3	A2160NS
21x72	530x1829	24	10.9	A2172NC	A2172NK3	A2172NS
24x24	610x610	9	4.1	A2424NC	A2424NK3	A2424NS
24x30	610x760	11	5.0	A2430NC	A2430NK3	A2430NS
24x36	610x914	13	5.9	A2436NC	A2436NK3	A2436NS
24x42	610x1066	15	6.8	A2442NC	A2442NK3	A2442NS
24x48	610x1219	16	7.3	A2448NC	A2448NK3	A2448NS
24x54	610x1370	18	8.6	A2454NC	A2454NK3	A2454NS
24x60	610x1524	21	9.5	A2460NC	A2460NK3	A2460NS
24x72	610x1829	26	11.8	A2472NC	A2472NK3	A2472NS
30x36	760x914	15	6.8	A3036NC		
30x48	760x1219	21	9.5	A3048NC		
30x60	760x1524	26½	11.8	A3060NC		
30x72	760x1829	31	14.0	A3072NC		
36x36	910x914	18	8.2	A3636NC		
36x48	910x1219	23	10.4	A3648NC		
36x60	910x1524	29	13.1	A3660NC		
36x72	910x1829	34½	15.4	A3672NC		

Note: The actual length of the shelves is 1/8" (3.2mm) shorter than the nominal dimension shown. The actual depth of the shelves is 1/8" (3.2mm) greater than the nominal dimension shown.
 Note: Wire shelves up to 48" (1219mm) long have a weight capacity of 800 lbs. (363kg); Shelves longer than 48" (1219mm) have a weight capacity of 600 lbs. (272kg) per shelf evenly distributed.
 Note: 14" (355mm) deep shelving – Stationary units taller than 63" (1600mm) must be fastened to the floor or wall using Metro foot plates or wall brackets. On mobile units the maximum allowable post height is 54" (1370mm).
 Note: Metroseal 3 is not cart-washable.

☑ Indicates antimicrobial product.

SiteSelect™ Posts — {10.01a} {10.10a}

Stationary Super Erecta® SiteSelect posts are fitted with adjustable leveling bolts to compensate for uneven surfaces. Mobile posts come without leveling bolt assembly to accommodate stem casters. Special length posts are available.†

STATIONARY						MOBILE					
Height* (in.)	(mm)	Approx. Pkd. Wt.		Cat. No. Chrome	Cat. No. Metroseal 3 with Microban*	Cat. No. Stainless**	Approx. Pkd. Wt. (lbs.)	(kg)	Cat. No. Plated	Cat. No. Metroseal 3 with Microban*	Cat. No. Stainless
		(lbs.)	(kg)								
7½	191	½	0.3	7P	7PK3						
14½	370	1	0.5	13P	13PK3	13PS	1	0.5	13UP	13UPK3	13UPS
27½	699	1¾	0.75	27P	27PK3	27PS	1¾	0.75	27UP	27UPK3	27UPS
34½	875	2	0.9	33P	33PK3	33PS	2	0.9	33UP	33UPK3	33UPS
54¾	1385	3	1.4	54P	54PK3	54PS	3	1.4	54UP	54UPK3	54UPS
62¾	1590	3½	1.6	63P	63PK3	63PS	3½	1.6	63UP	63UPK3	63UPS
74⅝	1895	4	1.8	74P	74PK3	74PS	3¾	1.7	74UP	74UPK3	74UPS
86⅝	2200	5	2.3	86P	86PK3	86PS	4	1.8	86UP	86UPK3	86UPS
96⅝	2454	5½	2.5	***96P			4.5	2.0	86UP	86UPK3	86UPS

*Height includes leveling bolt and cap.
 **Stainless stationary post includes stainless leveling bolt.
 ***96P should not be used on units less than 24" (610mm) deep. Consult Metro Engineering for alternate recommendations.
 †Note: Special length posts are available, priced at next higher length plus a cutting charge.
 Actual height of a stationary cut post is the nominal height plus 3/8" (10mm)

These posts come without leveling bolt assembly to accommodate stem casters.
 †Note: Actual height of a mobile cut post is the nominal height minus 1/4" (6mm)
 Casters for mobile applications can be found on pages 50 & 51.



Shelving Starter and Add-On Units — {10.91}

- Starter Units consist of four posts and indicated number of Super Adjustable Super Erecta shelves.
- Add-On Units consist of two posts, indicated number of shelves, and two “S” Hooks per shelf, for attaching shelf to adjacent unit.

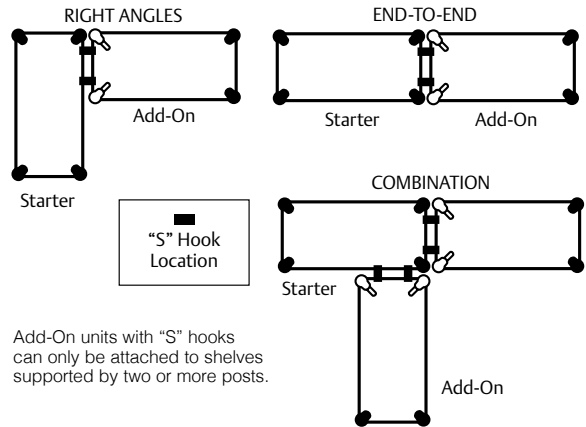

For additional wire shelves, order from page 37.

Chrome Four-Tier Unit with 63" posts

Nominal Width/Length (in.) (mm)	Approx. Pkd. Wt. (lbs.) (kg)	Cat. No. Starter Unit	Approx. Pkd. Wt. (lbs.) (kg)	Cat. No. Add-On Unit
18x24 457x610	42 19.1	A316C	35 15.9	AA316C
18x30 457x760	47 21.3	A326C	40 18.1	AA326C
18x36 457x914	53 24.0	A336C	46 20.9	AA336C
18x42 457x1060	57 25.9	A346C	50 22.7	AA346C
18x48 457x1219	63 28.6	A356C	56 25.4	AA356C
18x60 457x1524	82 37.2	A366C	75 34.0	AA366C
18x72 457x1829	94 42.6	A376C	87 39.5	AA376C
21x24 530x610	46 20.9	A416C	39 17.7	AA416C
21x30 530x760	52 23.6	A426C	45 20.4	AA426C
21x36 530x914	59 26.8	A436C	52 23.6	AA436C
21x42 530x1060	65 29.5	A446C	58 26.3	AA446C
21x48 530x1219	71 32.2	A456C	64 29.0	AA456C
21x60 530x1524	88 39.9	A466C	81 36.7	AA466C
21x72 530x1829	98 44.5	A476C	92 41.7	AA476C
24x24 610x610	50 22.7	A516C	43 19.5	AA516C
24x30 610x760	57 25.9	A526C	50 22.7	AA526C
24x36 610x914	65 29.5	A536C	58 26.3	AA536C
24x42 610x1060	72 32.7	A546C	65 29.5	AA546C
24x48 610x1219	79 35.8	A556C	72 32.7	AA556C
24x60 610x1524	98 44.5	A566C	91 41.3	AA566C
24x72 610x1829	120 54.4	A576C	113 51.3	AA576C

Actual Dimensions: Width: Add 1/8" (3.2mm) to nominal size.
Length: Subtract 1/8" (3.2mm) from nominal size.

Chrome Five-Tier Unit with 74" posts

Approx. Pkd. Wt. (lbs.) (kg)	Cat. No. Starter Unit	Approx. Pkd. Wt. (lbs.) (kg)	Cat. No. Add-On Unit
51 23.1	5A317C	43 19.5	5AA317C
58 26.3	5A327C	50 22.7	5AA327C
65 29.5	5A337C	57 25.9	5AA337C
70 31.8	5A347C	62 28.1	5AA347C
78 35.4	5A357C	70 31.8	5AA357C
102 46.3	5A367C	93 42.2	5AA367C
117 53.1	5A377C	108 49.0	5AA377C
57 25.9	5A417C	48 21.8	5AA417C
64 29.0	5A427C	56 25.4	5AA427C
73 33.1	5A437C	65 29.5	5AA437C
81 36.7	5A447C	73 33.1	5AA447C
88 39.9	5A457C	80 36.3	5AA457C
109 49.4	5A467C	101 45.8	5AA467C
122 55.3	5A477C	113 51.3	5AA477C
62 28.1	5A517C	53 24.0	5AA517C
71 32.2	5A527C	62 28.1	5AA527C
81 36.7	5A537C	73 33.1	5AA537C
89 40.4	5A547C	81 36.7	5AA547C
98 44.5	5A557C	90 40.8	5AA557C
122 55.3	5A567C	113 51.3	5AA567C
149 67.6	5A577C	141 64.0	5AA577C



Replacement “S” Hook

2 are required for each storage level.
Cat. No. 9995Z



Security “S” Hook

2 are required for each storage level.
Chrome. Cat. No. H9995C
Black. Cat. No. H9995B



Metroseal 3 Four-Tier Unit with 63" posts

Nominal Width/Length (in.) (mm)	Approx. Pkd. Wt. (lbs.) (kg)	Cat. No. Starter Unit	Approx. Pkd. Wt. (lbs.) (kg)	Cat. No. Add-On Unit
18x24 457x610	42 19.1	A316K3	35 15.9	AA316K3
18x30 457x760	47 21.3	A326K3	40 18.1	AA326K3
18x36 457x914	53 24.0	A336K3	46 20.9	AA336K3
18x42 457x1060	57 25.9	A346K3	50 22.7	AA346K3
18x48 457x1219	63 28.6	A356K3	56 25.4	AA356K3
18x60 457x1524	82 37.2	A366K3	75 34.0	AA366K3
18x72 457x1829	94 42.6	A376K3	87 39.5	AA376K3
21x24 530x610	46 20.9	A416K3	39 17.7	AA416K3
21x30 530x760	52 23.6	A426K3	45 20.4	AA426K3
21x36 530x914	59 26.8	A436K3	52 23.6	AA436K3
21x42 530x1060	65 29.5	A446K3	58 26.3	AA446K3
21x48 530x1219	71 32.2	A456K3	64 29.0	AA456K3
21x60 530x1524	88 39.9	A466K3	81 36.7	AA466K3
21x72 530x1829	98 44.5	A476K3	92 41.7	AA476K3
24x24 610x610	50 22.7	A516K3	43 19.5	AA516K3
24x30 610x760	57 25.9	A526K3	50 22.7	AA526K3
24x36 610x914	65 29.5	A536K3	58 26.3	AA536K3
24x42 610x1060	72 32.7	A546K3	65 29.5	AA546K3
24x48 610x1219	79 35.8	A556K3	72 32.7	AA556K3
24x60 610x1524	98 44.5	A566K3	91 41.3	AA566K3
24x72 610x1829	120 54.4	A576K3	113 51.3	AA576K3

Actual Dimensions: Width: Add 1/8" (3.2mm) to nominal size.
Length: Subtract 1/8" (3.2mm) from nominal size.°



Metroseal 3 Five-Tier Unit with 74" posts

Approx. Pkd. Wt. (lbs.) (kg)	Cat. No. Starter Unit	Approx. Pkd. Wt. (lbs.) (kg)	Cat. No. Add-On Unit
51 23.1	5A317K3	43 19.5	5AA317K3
58 26.3	5A327K3	50 22.7	5AA327K3
65 29.5	5A337K3	57 25.9	5AA337K3
70 31.8	5A347K3	62 28.1	5AA347K3
78 35.4	5A357K3	70 31.8	5AA357K3
102 46.3	5A367K3	93 42.2	5AA367K3
117 53.1	5A377K3	108 49.0	5AA377K3
57 25.9	5A417K3	48 21.8	5AA417K3
64 29.0	5A427K3	56 25.4	5AA427K3
73 33.1	5A437K3	65 29.5	5AA437K3
81 36.7	5A447K3	73 33.1	5AA447K3
88 39.9	5A457K3	80 36.3	5AA457K3
109 49.4	5A467K3	101 45.8	5AA467K3
122 55.3	5A477K3	113 51.3	5AA477K3
62 28.1	5A517K3	53 24.0	5AA517K3
71 32.2	5A527K3	62 28.1	5AA527K3
81 36.7	5A537K3	73 33.1	5AA537K3
89 40.4	5A547K3	81 36.7	5AA547K3
98 44.5	5A557K3	90 40.8	5AA557K3
122 55.3	5A567K3	113 51.3	5AA567K3
149 67.6	5A577K3	141 64.0	5AA577K3

Indicates antimicrobial product.

Super Adjustable Super Erecta® Stem Caster Carts — {11.01a}

- Consists of Super Adjustable Super Erecta wire shelves.
- 5" (127mm) resilient rubber or polyurethane casters with donut bumpers.



Super Adjustable Super Erecta® Wire Stem Caster Cart

Safely Hold up to **600 lbs.** per mobile unit.
"BC" models with resilient rubber casters.

Safely Hold up to **900 lbs.** per mobile unit.
"EC" models with polyurethane casters.

4-Tier Models – Chrome Shelves and Chrome-Plated Posts
Overall Height 67⁷/₈" (1724mm)

Shelf Width/Length (in.) (mm)	Approx. Pkd. Wt. (lbs.) (kg)	Catalog Number with Casters	
		Two Swivel Two Brake Resilient Rubber Casters	Two Swivel Two Brake Polyurethane Casters
18x36 457x914	60 27	A336BC	A336EC
18x48 457x1219	72 32	A356BC	A356EC
18x60 457x1524	88 40	A366BC	A366EC
21x36 530x914	69 31	A436BC	A436EC
21x48 530x1219	81 36	A456BC	A456EC
21x60 530x1524	98 44	A466BC	A466EC
24x36 610x914	76 34	A536BC	A536EC
24x48 610x1219	92 41	A556BC	A556EC
24x60 610x1524	112 51	A566BC	A566EC

5-Tier Models – With Chrome Shelves and Chrome-Plated Posts
Overall Height 67⁷/₈" (1724mm)

Shelf Width/Length (in.) (mm)	Approx. Pkd. Wt. (lbs.) (kg)	Catalog Number with Casters	
		Two Swivel Two Brake Resilient Rubber Casters	Two Swivel Two Brake Polyurethane Casters
18x36 457x914	60 27	5A336BC	5A336EC
18x48 457x1219	72 32	5A356BC	5A356EC
18x60 457x1524	88 40	5A366BC	5A366EC
21x36 530x914	69 31	5A436BC	5A436EC
21x48 530x1219	81 36	5A456BC	5A456EC
21x60 530x1524	98 44	5A466BC	5A466EC
24x36 610x914	76 34	5A536BC	5A536EC
24x48 610x1219	92 41	5A556BC	5A556EC
24x60 610x1524	112 51	5A566BC	5A566EC

Note: Models include 63UP posts. Use a solid shelf on the lowest levels to protect contents on the bottom of the cart from debris and dripping. (See page 75).

Genuine Metro

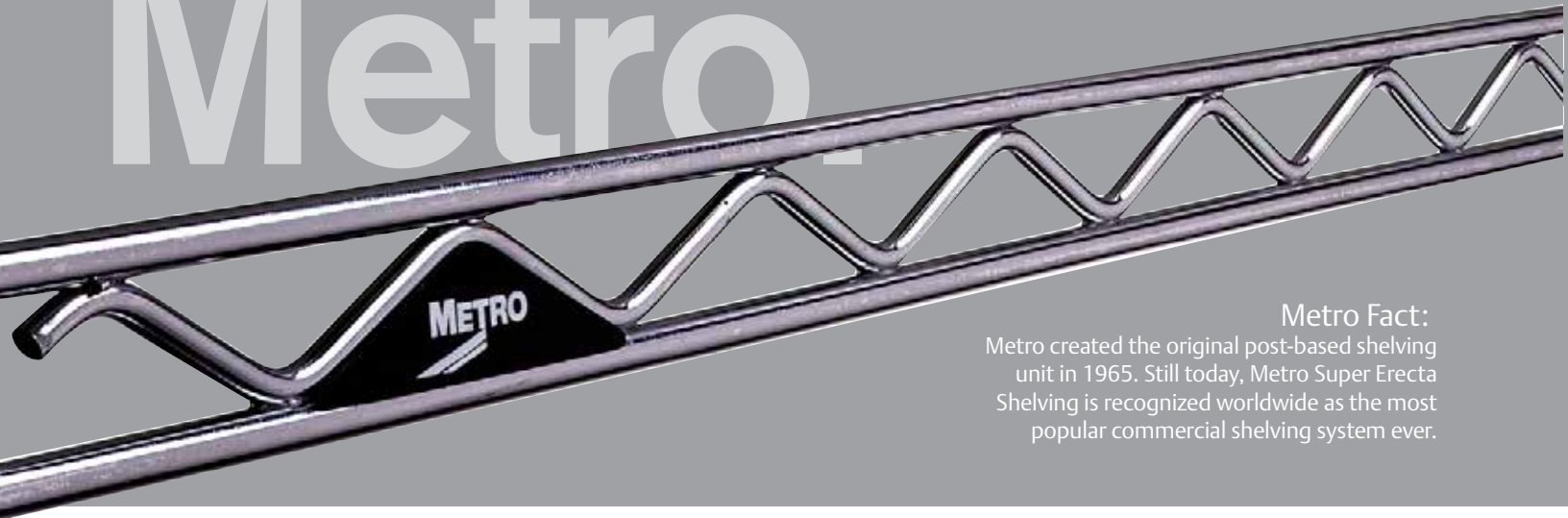

Metro Fact:
 Metro created the original post-based shelving unit in 1965. Still today, Metro Super Erecta Shelving is recognized worldwide as the most popular commercial shelving system ever.



Super Erecta® Shelving System

The original wire storage system.

A storage system that defines the extent of space, Super Erecta's revolutionary concept was fresh and innovative from its start — nearly 50 years ago. It has continued to evolve, with nearly 100 highly specialized accessories, aimed at meeting the diversity of today's challenges.

- Adjustable: Shelves can be repositioned at precise 1" (25mm) increments along the length of the numbered posts.
- Unique Design: Open-wire design minimizes dust accumulation, allows a free circulation of air, and greater visibility of stored items.
- Mobile: Full choice of caster types available for mobile applications.

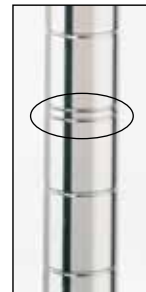

SiteSelect posts provide a visual guide for positioning and adjusting shelves, saving considerable time during assembly and adjustment. An easy-to-identify double groove, every 8" (203mm), offers a quick way to align all shelves.

Shelving Finishes Guide

	<p><i>Wire & Solid</i></p>	<p>Type 304 Polished Stainless Steel Addresses the most aggressive applications and environments. All-stainless solid and wire options exist for high temperature automated cart wash and autoclave applications.</p>	
	<p>Metroseal 3™ Epoxy</p>	<p>Corrosion resistant finish for wet or high humidity environments with a 12 year warranty against rust and corrosion. Microban antimicrobial is built into the finish to keep the product “cleaner between cleanings”.</p>	
	<p>Chrome Plating</p>	<p>The “real” nickel-chrome finish for dry, low humidity environments. Metro’s durable chrome finish includes a protective lacquer coat.</p>	
	<p>Brite</p>	<p>Economical, chromate finish for dry, low humidity environments. Metro’s Brite finish provides the look of chrome and includes a protective lacquer coat.</p>	

Standard Epoxy and Designer Finishes

A pleasing aesthetic and basic protection for dry environments.



Shelving Post Guide

Standard Stationary Post with adjustable leveling foot. Stainless models also feature a stainless leveling foot. Use Foot Plates for greater stability.

Standard Stem Caster Mobile Post accepts a Metro stem caster. Use these for the majority of standard duty transport and movable storage applications.

Cart Wash and Autoclave Applications

Swaged stainless post has a fastened aluminum post cap and is specifically designed to withstand high temperatures. See page 50 for part numbers.

Heavy Duty Transport

Staked post attaches to a dolly truck to address abusive transport applications. The reinforced connection between the base receptacle and post provides a more secure connection to the dolly truck. See page 52 for part numbers.



SUPER ERECTA® SHELVING SYSTEM



Wire Shelves — {10.01a} {10.10a}

Packaging: Wire shelves are priced individually and packaged no more than 4 per carton except 60" (1524mm) and 72" (1829mm) lengths and 30" (760mm) and 36" (914mm) widths, which are packaged no more than 2 per carton. Plastic sleeves and wedges are included with each shelf.

Width/Length (in./mm)		Approx. Pkd. Wt. (lbs./kg)		Cat. No. Super Erecta Brite	Cat. No. Chrome	Cat. No. Metroseal 3 with Microban®	Cat. No. Stainless
14x24	355x610	6	2.7	1424BR	1424NC	1424NK3	1424NS
14x30	355x760	7	3.2	1430BR	1430NC	1430NK3	1430NS
14x36	355x914	8	3.6	1436BR	1436NC	1436NK3	1436NS
14x42	355x1066	9 1/2	4.3	1442BR	1442NC	1442NK3	1442NS
14x48	355x1219	10 1/2	4.7	1448BR	1448NC	1448NK3	1448NS
14x60	355x1524	14	6.3	1460BR	1460NC	1460NK3	1460NS
14x72	355x1829	17	7.7	1472BR	1472NC	1472NK3	1472NS
18x18	457x457	6	2.7	N/A	1818NC	N/A	N/A
18x24	457x610	7	3.2	1824BR	1824NC	1824NK3	1824NS
18x30	457x760	8	3.6	1830BR	1830NC	1830NK3	1830NS
18x36	457x914	9 1/2	4.3	1836BR	1836NC	1836NK3	1836NS
18x42	457x1066	11	5.0	1842BR	1842NC	1842NK3	1842NS
18x48	457x1219	12	5.4	1848BR	1848NC	1848NK3	1848NS
18x54	457x1370	14 1/2	6.6	1854BR	1854NC	1854NK3	1854NS
18x60	457x1524	17	7.7	1860BR	1860NC	1860NK3	1860NS
18x72	457x1829	20	9.1	1872BR	1872NC	1872NK3	1872NS
21x24	530x610	8	3.6	2124BR	2124NC	2124NK3	2124NS
21x30	530x760	9	4.1	2130BR	2130NC	2130NK3	2130NS
21x36	530x914	11	5.0	2136BR	2136NC	2136NK3	2136NS
21x42	530x1066	12	5.4	2142BR	2142NC	2142NK3	2142NS
21x48	530x1219	14	6.4	2148BR	2148NC	2148NK3	2148NS
21x54	530x1370	16	7.3	2154BR	2154NC	2154NK3	2154NS
21x60	530x1524	18	8.2	2160BR	2160NC	2160NK3	2160NS
21x72	530x1829	24	10.9	2172BR	2172NC	2172NK3	2172NS
24x24	610x610	9	4.1	2424BR	2424NC	2424NK3	2424NS
24x30	610x760	11	5.0	2430BR	2430NC	2430NK3	2430NS
24x36	610x914	13	5.9	2436BR	2436NC	2436NK3	2436NS
24x42	610x1066	15	6.8	2442BR	2442NC	2442NK3	2442NS
24x48	610x1219	16	7.3	2448BR	2448NC	2448NK3	2448NS
24x54	610x1370	19	8.6	2454BR	2454NC	2454NK3	2454NS
24x60	610x1524	21	9.5	2460BR	2460NC	2460NK3	2460NS
24x72	610x1829	26	11.8	2472BR	2472NC	2472NK3	2472NS
30x36	760x914	15	6.8		3036NC	3036NK3	3036NS
30x48	760x1219	21	9.5		3048NC	3048NK3	3048NS
30x60	760x1524	26 1/2	11.8		3060NC	3060NK3	3060NS
30x72	760x1829	31	14.0		3072NC	3072NK3	3072NS
36x36	910x914	18	8.2		3636NC	3636NK3	3636NS
36x48	910x1219	23	10.4		3648NC	3648NK3	3648NS
36x60	910x1524	29	13.1		3660NC	3660NK3	3660NS
36x72	910x1829	34 1/2	15.4		3672NC	3672NK3	3672NS

Note: The actual length of the shelves is 1/8" (3.2mm) shorter than the nominal dimension shown. The actual depth of the shelves is 1/8" (3.2mm) greater than the nominal dimension shown.
 Note: Wire shelves up to 48" (1219mm) long have a weight capacity of 800 lbs. (363kg); Shelves longer than 48" (1219mm) have a weight capacity of 600 lbs. (272kg) per shelf evenly distributed.
 Note: 14" (355mm) deep shelving – Stationary units taller than 63" (1600mm) must be fastened to the floor or wall using Metro foot plates or wall brackets. On mobile units the maximum allowable post height is 54" (1370mm).
 Note: Metroseal 3 is not cart-washable.

SiteSelect™ Posts — {10.01a} {10.10a}

Stationary Super Erecta® SiteSelect posts are fitted with adjustable leveling bolts to compensate for uneven surfaces. Mobile posts come without leveling bolt assembly to accommodate stem casters. Special length posts are available.†

STATIONARY						MOBILE				
Height* (in./mm)	Approx. Pkd. Wt. (lbs./kg)	Cat. No. Chrome	Cat. No. Metroseal 3 with Microban®	Cat. No. Stainless**		Approx. Pkd. Wt. (lbs./kg)	Cat. No. Plated	Cat. No. Metroseal 3 with Microban®	Cat. No. Stainless	
7 1/2 191	1/2 0.3	7P	7PK3							
14 1/2 370	1 0.5	13P	13PK3	13PS		1 0.5	13UP	13UPK3	13UPS	
27 1/2 699	1 3/4 0.75	27P	27PK3	27PS		1 3/4 0.75	27UP	27UPK3	27UPS	
34 1/2 875	2 0.9	33P	33PK3	33PS		2 0.9	33UP	33UPK3	33UPS	
54 9/16 1385	3 1.4	54P	54PK3	54PS		3 1.4	54UP	54UPK3	54UPS	
62 9/16 1590	3 1/2 1.6	63P	63PK3	63PS		3 1/2 1.6	63UP	63UPK3	63UPS	
						3 3/4 1.7		70UPK3		
74 5/8 1895	4 1.8	74P	74PK3	74PS		4 1.8	74UP	74UPK3	74UPS	
86 5/8 2200	5 2.3	86P	86PK3	86PS		4.5 2.0	86UP	86UPK3	86UPS	
96 5/8 2454	5 1/2 2.5	***96P								

*Height includes leveling bolt and cap.
 **Stainless stationary post includes stainless leveling bolt.
 ***96P should not be used on units less than 24" (610mm) deep. Consult Metro Engineering for alternate recommendations.
 †Note: Special length posts are available, priced at next higher length plus a cutting charge.
 Actual height of a stationary cut post is the nominal height plus 3/8" (10mm)

Indicates antimicrobial product.

Designer Color Shelving — {10.14}

Available in a wide spectrum of colors that complement any decor.

Width/Length (in.) (mm)	Approx. Pkd. Wt. (lbs.) (kg)	STANDARD COLORS			DESIGNER COLORS			
		Cat. No. Black	Cat. No. White	Cat. No. Smoked Glass	Cat. No. Flame†	Cat. No. Designer Colors*		
14x24	355x610	6	2.7	1424NBL	1424NW	1424N-DSG	1424NF	1424N-D
14x30	355x760	7	3.2	1430NBL	1430NW	1430N-DSG	1430NF	1430N-D
14x36	355x914	8	3.6	1436NBL	1436NW	1436N-DSG	1436NF	1436N-D
14x42	355x1066	9½	4.3	1442NBL	1442NW	1442N-DSG	1442NF	1442N-D
14x48	355x1219	10½	4.7	1448NBL	1448NW	1448N-DSG	1448NF	1448N-D
14x60	355x1524	14	6.3	1460NBL	1460NW	1460N-DSG	1460NF	1460N-D
14x72	355x1829	17	7.7	1472NBL	1472NW	1472N-DSG	1472NF	1472N-D
18x18	457x457	6	2.7	1818NBL	1818NW	1818N-DSG	1818NF	1818N-D
18x24	457x610	7	3.2	1824NBL	1824NW	1824N-DSG	1824NF	1824N-D
18x30	457x760	8	3.6	1830NBL	1830NW	1830N-DSG	1830NF	1830N-D
18x36	457x914	9½	4.3	1836NBL	1836NW	1836N-DSG	1836NF	1836N-D
18x42	457x1066	11	5.0	1842NBL	1842NW	1842N-DSG	1842NF	1842N-D
18x48	457x1219	12	5.4	1848NBL	1848NW	1848N-DSG	1848NF	1848N-D
18x54	457x1370	14½	6.4	1854NBL	1854NW	1854N-DSG	1854NF	1854N-D
18x60	457x1524	17	7.7	1860NBL	1860NW	1860N-DSG	1860NF	1860N-D
18x72	457x1829	20	9.1	1872NBL	1872NW	1872N-DSG	1872NF	1872N-D
21x24	530x610	8	3.6	2124NBL	2124NW	2124N-DSG	2124NF	2124N-D
21x30	530x760	9	4.1	2130NBL	2130NW	2130N-DSG	2130NF	2130N-D
21x36	530x914	11	5.0	2136NBL	2136NW	2136N-DSG	2136NF	2136N-D
21x42	530x1066	12	5.4	2142NBL	2142NW	2142N-DSG	2142NF	2142N-D
21x48	530x1219	14	6.4	2148NBL	2148NW	2148N-DSG	2148NF	2148N-D
21x54	530x1370	16	7.3	2154NBL	2154NW	2154N-DSG	2154NF	2154N-D
21x60	530x1524	18	8.2	2160NBL	2160NW	2160N-DSG	2160NF	2160N-D
21x72	530x1829	24	10.9	2172NBL	2172NW	2172N-DSG	2172NF	2172N-D
24x24	610x610	9	4.1	2424NBL	2424NW	2424N-DSG	2424NF	2424N-D
24x30	610x760	11	5.0	2430NBL	2430NW	2430N-DSG	2430NF	2430N-D
24x36	610x914	13	5.9	2436NBL	2436NW	2436N-DSG	2436NF	2436N-D
24x42	610x1066	15	6.8	2442NBL	2442NW	2442N-DSG	2442NF	2442N-D
24x48	610x1219	16	7.3	2448NBL	2448NW	2448N-DSG	2448NF	2448N-D
24x54	610x1370	19	8.6	2454NBL	2454NW	2454N-DSG	2454NF	2454N-D
24x60	610x1524	21	9.5	2460NBL	2460NW	2460N-DSG	2460NF	2460N-D
24x72	610x1829	26	11.8	2472NBL	2472NW	2472N-DSG	2472NF	2472N-D

Note: White epoxy Super Erecta shelves come with white split sleeves.

Note: All Black, Smoked Glass and Designer Super Erecta shelves come with black split sleeves.

Note: Black shelving is NSF listed. White, Smoked Glass, and Designer Colors are not NSF listed.

Posts — {10.14}

Height* (in.) (mm)	Approx. Pkd. Wt. (lbs.) (kg)	STATIONARY					MOBILE (FOR STEM CASTERS)								
		Cat. No. Black	Cat. No. White	Cat. No. Smoked Glass	Cat. No. Flame†	Cat. No. Designer Colors††	Cat. No. Black	Cat. No. White	Cat. No. Smoked Glass	Cat. No. Flame†	Cat. No. Designer Colors††				
7½	191	½	0.3	7PBL	7PW	7P-DSG	7PF	7P-D	—	—	—	—	—		
14½	370	1	0.5	13PBL	13PW	13P-DSG	13PF	13P-D	—	—	—	—	—		
27½	699	1¾	0.75	27PBL	27PW	27P-DSG	27PF	27P-D	1¾	0.75	27UPBL	27UPW	27UP-DSG	27UPF	27UP-D
34½	875	2	0.9	33PBL	33PW	33P-DSG	33PF	33P-D	2	0.9	33UPBL	33UPW	33UP-DSG	33UPF	33UP-D
54¾	1385	3	1.4	54PBL	54PW	54P-DSG	54PF	54P-D	3	1.4	54UPBL	54UPW	54UP-DSG	54UPF	54UP-D
62¾	1590	3½	1.6	63PBL	63PW	63P-DSG	63PF	63P-D	3½	1.6	63UPBL	63UPW	63UP-DSG	63UPF	63UP-D
74¾	1895	4	1.8	74PBL	74PW	74P-DSG	74PF	74P-D	4	1.8	74UPBL	74UPW	74UP-DSG	74UPF	74UP-D
86¾	2200	5	2.3	86PBL	86PW	86P-DSG	86PF	86P-D	4.5	2.0	86UPBL	86UPW	86UP-DSG	86UPF	86UP-D

† Contact your Metro representative for pricing on Stationary and Mobile Designer Color Posts.

Standard Colors			Designer Colors*		
Black	White	Smoked Glass	Flame (F)	Copper Hammertone (CH)	Silver Hammertone (SH)

*For Designer Colors: CH, SH

*To order a Designer Color, add the appropriate color suffix to the desired catalog numbers above.

 Example: 18" x 36" (457 x 914mm) Copper Hammertone Shelf = 1836N-DCH
 74" (1880mm) stationary Copper Hammertone Post = 74P-DCH.

SUPER ERECTA® STARTER AND ADD-ON UNITS



Shelving Starter and Add-On Units — {10.90}

- Starter Units consist of four posts and indicated number of Super Erecta shelves.
- Add-On Units consist of two posts, indicated number of shelves, and two “S” Hooks per shelf, for attaching shelf to adjacent unit.

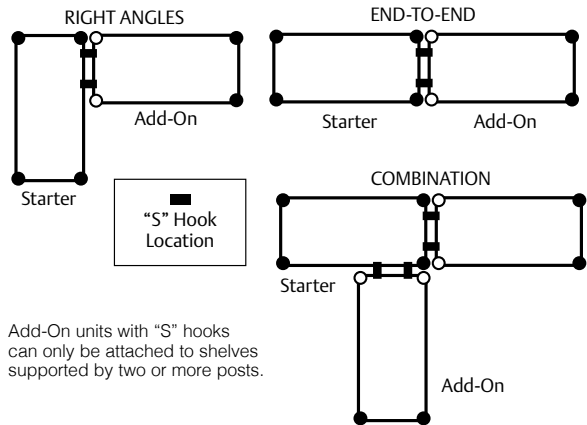

Add-On units with “S” hooks can only be attached to shelves supported by two or more posts.

For additional wire shelves, order from page 42.

Easy Order — Chrome Finish

Chrome Four-Tier Unit with 63" posts

Nominal Width/Length (in.) (mm)	Approx. Pkd. Wt. (lbs.) (kg)		Cat. No. Starter Unit	Approx. Pkd. Wt. (lbs.) (kg)		Cat. No. Add-On Unit
18x24	457x610	42.0 19.1	N316C	35.0 15.9	AN316C	
18x30	457x760	47.0 21.3	N326C	40.0 18.1	AN326C	
18x36	457x914	53.0 24.0	N336C	46.0 20.9	AN336C	
18x42	457x1060	57.0 25.9	N346C	50.0 22.7	AN346C	
18x48	457x1219	63.0 28.6	N356C	56.0 25.4	AN356C	
18x60	457x1524	82.0 37.2	N366C	75.0 34.0	AN366C	
18x72	457x1829	94.0 42.6	N376C	87.0 39.5	AN376C	
21x24	530x610	46.0 20.9	N416C	39.0 20.9	AN416C	
21x30	530x760	52.0 23.6	N426C	45.0 23.6	AN426C	
21x36	530x914	59.0 26.8	N436C	52.0 26.8	AN436C	
21x42	530x1060	65.0 29.5	N446C	58.0 29.5	AN446C	
21x48	530x1219	71.0 32.2	N456C	64.0 32.2	AN456C	
21x60	530x1524	88.0 39.9	N466C	81.0 39.9	AN466C	
21x72	530x1829	98.0 44.5	N476C	92.0 44.5	AN476C	
24x24	610x610	50.0 22.7	N516C	43.0 19.5	AN516C	
24x30	610x760	57.0 25.9	N526C	50.0 22.7	AN526C	
24x36	610x914	65.0 29.5	N536C	58.0 26.3	AN536C	
24x42	610x1060	72.0 32.7	N546C	65.0 29.5	AN546C	
24x48	610x1219	79.0 35.8	N556C	72.0 32.7	AN556C	
24x60	610x1524	98.0 44.5	N566C	91.0 41.3	AN566C	
24x72	610x1829	120.0 54.4	N576C	113.0 51.3	AN576C	

Actual Dimensions: Width: Add 1/8" (3.2mm) to nominal size.
Length: Subtract 1/8" (3.2mm) from nominal size.

Chrome Five-Tier Unit with 74" posts

Approx. Pkd. Wt. (lbs.) (kg)	Cat. No. Starter Unit	Approx. Pkd. Wt. (lbs.) (kg)		Cat. No. Add-On Unit
51.0 23.1	5N317C	43.0 19.5	5AN317C	
58.0 26.3	5N327C	50.0 22.7	5AN327C	
65.0 29.5	5N337C	57.0 25.9	5AN337C	
70.0 31.8	5N347C	62.0 28.1	5AN347C	
78.0 35.4	5N357C	70.0 31.8	5AN357C	
102.0 46.3	5N367C	93.0 42.2	5AN367C	
117.0 53.1	5N377C	108.0 49.0	5AN377C	
57.0 25.9	5N417C	48.0 21.8	5AN417C	
64.0 29.0	5N427C	56.0 25.4	5AN427C	
73.0 33.1	5N437C	65.0 29.5	5AN437C	
81.0 36.7	5N447C	73.0 33.1	5AN447C	
88.0 39.9	5N457C	80.0 36.3	5AN457C	
109.0 49.4	5N467C	101.0 45.8	5AN467C	
122.0 55.3	5N477C	113.0 51.3	5AN477C	
62.0 28.1	5N517C	53.0 24.0	5AN517C	
71.0 32.2	5N527C	62.0 28.1	5AN527C	
81.0 36.7	5N537C	73.0 33.1	5AN537C	
89.0 40.4	5N547C	81.0 36.7	5AN547C	
98.0 44.5	5N557C	90.0 40.8	5AN557C	
122.0 55.3	5N567C	113.0 51.3	5AN567C	
149.0 67.6	5N577C	141.0 64.0	5AN577C	



Replacement “S” Hook

2 are required for each storage level.
Cat. No. 9995Z



Security “S” Hook

2 are required for each storage level. Bag of 2.
Chrome. Cat. No. H9995C
Black. Cat. No. H9995B

Easy Order — Brite Finish

Brite Four-Tier Unit with 63" posts

Nominal Width/Length (in.) (mm)	Approx. Pkd. Wt. (lbs.) (kg)		Cat. No. Starter Unit	Approx. Pkd. Wt. (lbs.) (kg)		Cat. No. Add-On Unit
18x24	457x610	42.0 19.1	N316BR	35.0 15.9	AN316BR	
18x30	457x760	47.0 21.3	N326BR	40.0 18.1	AN326BR	
18x36	457x914	53.0 24.0	N336BR	46.0 20.9	AN336BR	
18x42	457x1060	57.0 25.9	N346BR	50.0 22.7	AN346BR	
18x48	457x1219	63.0 28.6	N356BR	56.0 25.4	AN356BR	
18x60	457x1524	82.0 37.2	N366BR	75.0 34.0	AN366BR	
18x72	457x1829	94.0 42.6	N376BR	87.0 39.5	AN376BR	
21x24	530x610	46.0 20.9	N416BR	39.0 20.9	AN416BR	
21x30	530x760	52.0 23.6	N426BR	45.0 23.6	AN426BR	
21x36	530x914	59.0 26.8	N436BR	52.0 26.8	AN436BR	
21x42	530x1060	65.0 29.5	N446BR	58.0 29.5	AN446BR	
21x48	530x1219	71.0 32.2	N456BR	64.0 32.2	AN456BR	
21x60	530x1524	88.0 39.9	N466BR	81.0 39.9	AN466BR	
21x72	530x1829	98.0 44.5	N476BR	92.0 44.5	AN476BR	
24x24	610x610	50.0 22.7	N516BR	43.0 19.5	AN516BR	
24x30	610x760	57.0 25.9	N526BR	50.0 22.7	AN526BR	
24x36	610x914	65.0 29.5	N536BR	58.0 26.3	AN536BR	
24x42	610x1060	72.0 32.7	N546BR	65.0 29.5	AN546BR	
24x48	610x1219	79.0 35.8	N556BR	72.0 32.7	AN556BR	
24x60	610x1524	98.0 44.5	N566BR	91.0 41.3	AN566BR	
24x72	610x1829	120.0 54.4	N576BR	113.0 51.3	AN576BR	

Actual Dimensions: Width: Add 1/8" (3.2mm) to nominal size.
Length: Subtract 1/8" (3.2mm) from nominal size.

Brite Five-Tier Unit with 74" posts

Approx. Pkd. Wt. (lbs.) (kg)	Cat. No. Starter Unit	Approx. Pkd. Wt. (lbs.) (kg)		Cat. No. Add-On Unit
51.0 23.1	5N317BR	43.0 19.5	5AN317BR	
58.0 26.3	5N327BR	50.0 22.7	5AN327BR	
65.0 29.5	5N337BR	57.0 25.9	5AN337BR	
70.0 31.8	5N347BR	62.0 28.1	5AN347BR	
78.0 35.4	5N357BR	70.0 31.8	5AN357BR	
102.0 46.3	5N367BR	93.0 42.2	5AN367BR	
117.0 53.1	5N377BR	108.0 49.0	5AN377BR	
57.0 25.9	5N417BR	48.0 21.8	5AN417BR	
64.0 29.0	5N427BR	56.0 25.4	5AN427BR	
73.0 33.1	5N437BR	65.0 29.5	5AN437BR	
81.0 36.7	5N447BR	73.0 33.1	5AN447BR	
88.0 39.9	5N457BR	80.0 36.3	5AN457BR	
109.0 49.4	5N467BR	101.0 45.8	5AN467BR	
122.0 55.3	5N477BR	113.0 51.3	5AN477BR	
62.0 28.1	5N517BR	53.0 24.0	5AN517BR	
71.0 32.2	5N527BR	62.0 28.1	5AN527BR	
81.0 36.7	5N537BR	73.0 33.1	5AN537BR	
89.0 40.4	5N547BR	81.0 36.7	5AN547BR	
98.0 44.5	5N557BR	90.0 40.8	5AN557BR	
122.0 55.3	5N567BR	113.0 51.3	5AN567BR	
149.0 67.6	5N577BR	141.0 64.0	5AN577BR	

Easy Order — Metroseal 3 Finish



Metroseal 3 Four-Tier Unit with 63" posts

Nominal Width/Length (in.) (mm)	Approx. Pkd. Wt. (lbs.) (kg)		Cat. No. Starter Unit	Approx. Pkd. Wt. (lbs.) (kg)		Cat. No. Add-On Unit
18x24	457x610	42.0 19.1	N316K3	35.0 15.9	AN316K3	
18x30	457x760	47.0 21.3	N326K3	40.0 18.1	AN326K3	
18x36	457x914	53.0 24.0	N336K3	46.0 20.9	AN336K3	
18x42	457x1060	57.0 25.9	N346K3	50.0 22.7	AN346K3	
18x48	457x1219	63.0 28.6	N356K3	56.0 25.4	AN356K3	
18x60	457x1524	82.0 37.2	N366K3	75.0 34.0	AN366K3	
18x72	457x1829	94.0 42.6	N376K3	87.0 39.5	AN376K3	
21x24	530x610	46.0 20.9	N416K3	46.0 20.9	AN416K3	
21x30	530x760	52.0 23.6	N426K3	52.0 23.6	AN426K3	
21x36	530x914	59.0 26.8	N436K3	59.0 26.8	AN436K3	
21x42	530x1060	65.0 29.5	N446K3	65.0 29.5	AN446K3	
21x48	530x1219	71.0 32.2	N456K3	71.0 32.2	AN456K3	
21x60	530x1524	88.0 39.9	N466K3	88.0 39.9	AN466K3	
21x72	530x1829	98.0 44.5	N476K3	98.0 44.5	AN476K3	
24x24	610x610	50.0 22.7	N516K3	43.0 19.5	AN516K3	
24x30	610x760	57.0 25.9	N526K3	50.0 22.7	AN526K3	
24x36	610x914	65.0 29.5	N536K3	58.0 26.3	AN536K3	
24x42	610x1060	72.0 32.7	N546K3	65.0 29.5	AN546K3	
24x48	610x1219	79.0 35.8	N556K3	72.0 32.7	AN556K3	
24x60	610x1524	98.0 44.5	N566K3	91.0 41.3	AN566K3	
24x72	610x1829	120.0 54.4	N576K3	113.0 51.3	AN576K3	

Actual Dimensions: Width: Add 1/8" (3.2mm) to nominal size.
Length: Subtract 1/8" (3.2mm) from nominal size.

Metroseal 3 Five-Tier Unit with 74" posts

Approx. Pkd. Wt. (lbs.) (kg)	Cat. No. Starter Unit	Approx. Pkd. Wt. (lbs.) (kg)		Cat. No. Add-On Unit
51.0 23.1	5N317K3	43.0 19.5	5AN317K3	
58.0 26.3	5N327K3	50.0 22.7	5AN327K3	
65.0 29.5	5N337K3	57.0 25.9	5AN337K3	
70.0 31.8	5N347K3	62.0 28.1	5AN347K3	
78.0 35.4	5N357K3	70.0 31.8	5AN357K3	
102.0 46.3	5N367K3	93.0 42.2	5AN367K3	
117.0 53.1	5N377K3	108.0 49.0	5AN377K3	
57.0 25.9	5N417K3	48.0 21.8	5AN417K3	
64.0 29.0	5N427K3	56.0 25.4	5AN427K3	
73.0 33.1	5N437K3	65.0 29.5	5AN437K3	
81.0 36.7	5N447K3	73.0 33.1	5AN447K3	
88.0 39.9	5N457K3	80.0 36.3	5AN457K3	
109.0 49.4	5N467K3	101.0 45.8	5AN467K3	
122.0 55.3	5N477K3	113.0 51.3	5AN477K3	
62.0 28.1	5N517K3	53.0 24.0	5AN517K3	
71.0 32.2	5N527K3	62.0 28.1	5AN527K3	
81.0 36.7	5N537K3	73.0 33.1	5AN537K3	
89.0 40.4	5N547K3	81.0 36.7	5AN547K3	
98.0 44.5	5N557K3	90.0 40.8	5AN557K3	
122.0 55.3	5N567K3	113.0 51.3	5AN567K3	
149.0 67.6	5N577K3	141.0 64.0	5AN577K3	

Add-on units with "S" hooks can only be attached to shelves supported by two or more posts.

Indicates antimicrobial product.



Convenience Pak unit in Chrome finish

Super Erecta® Convenience Pak™ — {10.03}

- Providing a complete shelving unit in a single box, Convenience Pak shelving is the easy-to-order alternative to separate shelving components.
- Available in Super Erecta Brite, chrome and Metroseal 3 finishes.

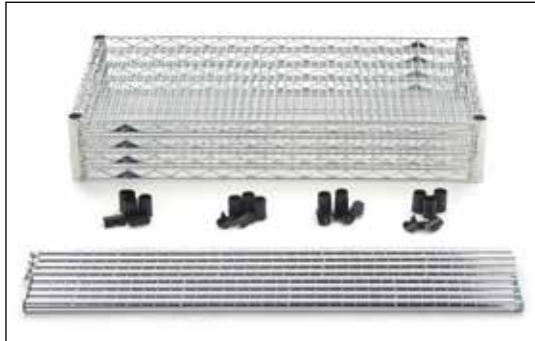

Unassembled Convenience Pak™
Each pack includes four shelves with split sleeves and four split posts with threaded connectors and leveling feet.

Width/Length/Height (in.) (mm)		Approx. Pkd. Wt. (lbs.) (kg)	Cat. No. Super Erecta Brite	Cat. No. Chrome	Cat. No. Metroseal 3 with Microban®
18x36x74 ¹ / ₂	457x914x1890	51 23	EZ1836BR-4	EZ1836NC-4	EZ1836NK3-4
18x48x74 ¹ / ₂	457x1219x1890	63 28.5	EZ1848BR-4	EZ1848NC-4	EZ1848NK3-4
18x60x74 ¹ / ₂	457x1524x1890	82 37	EZ1860BR-4	EZ1860NC-4	EZ1860NK3-4
24x36x74 ¹ / ₂	610x914x1890	66 30	EZ2436BR-4	EZ2436NC-4	EZ2436NK3-4
24x48x74 ¹ / ₂	610x1219x1890	76 34.5	EZ2448BR-4	EZ2448NC-4	EZ2448NK3-4
24x60x74 ¹ / ₂	610x1524x1890	102 46	EZ2460BR-4	EZ2460NC-4	EZ2460NK3-4

Heavy-Duty Dunnage Shelves — {10.45}

Enhance the weight-bearing capacity of your system.

- 36" (914mm) shelf holds 1,600 pounds (725kg) (uniformly distributed); 48" (1219mm) shelves carry up to 1,300 pounds (590kg); 60" (1524mm) shelves bear up to 1,000 pounds (453kg).
- Removable wire mat: Lifts off for easy cleaning. ⁵/₁₆" (7.9mm) diameter wire.
- Support frames: 1" (25mm) square tubing.



Dunnage Shelf

Width/Length (in.) (mm)	Approx. Pkd. Wt. (lbs.) (kg)	Cat. No. Chrome	Cat. No. Metroseal 3 with Microban®	Cat. No. Stainless
18x24 457x610	14 6.3	1824DRC	1824DRK3	—
18x30 457x760	18 8.1	1830DRC	1830DRK3	—
18x36 457x914	21 9.4	1836DRC	1836DRK3	1836DRS
18x48 457x1219	28 12.6	1848DRC	1848DRK3	1848DRS
18x60 457x1524	34 15.3	1860DRC	1860DRK3	1860DRS
24x24 610x610	16 7.2	2424DRC	2424DRK3	—
24x30 610x760	20 9.0	2430DRC	2430DRK3	—
24x36 610x914	24 10.8	2436DRC	2436DRK3	2436DRS
24x48 610x1219	30 13.5	2448DRC	2448DRK3	2448DRS
24x60 610x1524	37 16.6	2460DRC	2460DRK3	2460DRS

Important: In stationary shelving, stability decreases as the ratio of height to width increases and when heavier loads are placed on upper shelves. Shelving stability is attained by keeping units as wide and low as possible, and placing heavy loads low on the shelving unit.

Cantilever Shelves — {10.05}

Adds convenient space above a storage unit. Drop mat design creates a retaining ledge around the entire 12" (305mm) deep shelf. Remember to order rear posts taller than front posts to accommodate these shelves.



Cantilever Shelves

Length (in.) (mm)	Approx. Pkd. Wt. Each (lbs.) (kg)	Cat. No. Chrome	Cat. No. Black	Cat. No. White	Cat. No. Smoked Glass
24 610	4 ¹ / ₂ 2.0	1224CSNC	1224CSNBL	1224CSNW	1224CSN-DSG
30 750	5 2.3	1230CSNC	1230CSNBL	1230CSNW	1230CSN-DSG
36 914	5 ³ / ₄ 2.6	1236CSNC	1236CSNBL	1236CSNW	1236CSN-DSG
42 1066	6 ³ / ₄ 3.1	1242CSNC	1242CSNBL	1242CSNW	1242CSN-DSG
48 1219	7 ³ / ₄ 3.5	1248CSNC	1248CSNBL	1248CSNW	1248CSN-DSG
60 1524	9 ¹ / ₂ 4.3	1260CSNC	1260CSNBL	1260CSNW	1260CSN-DSG

✓ Indicates antimicrobial product.

Foot Plates — {10.06}

Use to bolt units to the floor, or when a broader, more stable foot is desired.
Zinc. Cat. No. 9993Z
Stainless Steel.
Cat. No. 9993S
Black. Cat. No. 9993BL



Glides — {10.06}

Smooth polymer cover fits over leveling bolt to protect floors.
Cat. No. 9991P



Decorative Leveling Foot — {10.06}

Decorative alternative for post. Compensates for uneven surfaces.
Chrome. Cat. No. HDFC
Black. Cat. No. HDFB



Wall Clamp — {10.06}

- Use to secure a stationary unit to the wall for greater stability. Plated finish.
- Compatible with Super Erecta wire shelves and Super Adjustable Super Erecta wire shelves.
Cat. No. 9984C



Post Clamps — {10.06}

Joins units together for maximum strength.
Zinc-plated. Cat. No. 9994Z
Black. Cat. No. 9994BL



Basket Shelf — {10.04}

3 1/2" (89mm) deep basket with 400 lb. (182kg) weight capacity. Ideal for containing and displaying smaller items.

(in.)	Size (mm)	Cat. No. Chrome	Cat. No. Black
14x36	355x914	—	DD3448A
14x48	355x1219	—	DD3448B
18x36	457x914	CC9744A	CC9744C
18x48	457x1219	CC9744	CC9744B



Basket Shelf
(Posts sold separately, see page 42)

Aluminum Split Sleeves — {10.06}

For high temperature, over the road, or conductive applications. Zinc or stainless steel retainer rings available to secure shelf. One bag required per shelf; 4 pairs per bag.



	Cat. No.
Aluminum Split Sleeves with Zinc Rings	9986Z
Aluminum Split Sleeves with Stainless Rings	9986S

Replacement Plastic Split Sleeves — {10.06}

One bag required per shelf; 4 pairs per bag.



Black Split Sleeve



White Split Sleeve

	Cat. No.
Black Plastic Split Sleeves	9985
White Plastic Split Sleeves	9985W

Note: White post caps and white split sleeves are standard with white designer shelving only.

Replacement Super Adjustable Kit — {10.06}

Package includes 4 wedges, 4 sleeves, and 4 corner releases.
Cat. No. SAKITA2



Super Erecta Mobile Shelving and Transport Carts

Stem Caster Carts (Standard-Duty Mobile Shelving)

- The most common configuration for mobile shelving.
- They are primarily used for applications where the shelving is periodically moved to clean or to transport goods short distances within a facility.
- The weight capacity of the cart is determined by the casters. Typical configurations range from 600-900 lbs. (272-363kg) total unit capacity.

Dolly Trucks (Heavy-Duty Mobile Shelving)

- Carts configured with dolly bases are recommended for heavier duty applications. The dolly base is shock absorbent and the heavier duty plate casters are designed to withstand abusive conditions.
- Dolly trucks are recommended when the carts must travel longer distances, over thresholds, and/or between facilities on a regular basis.
- Dolly trucks can transport up to 1,000 lbs. (454kg) evenly distributed.



Safely Hold up to **600-900 lbs.** per mobile unit.



HIGH TRAFFIC. EXTREME IMPACT.

Safely Hold up to **1000 lbs.** per mobile unit.



Wire Stem Caster Cart

Stem Caster Carts — Wire — {11.01}

Open-wire shelf design minimizes dust and increases air circulation and visibility. Casters included.

Overall Height 67⁷/₈" (1724mm). Carts are configured with 63UP posts.

Shelf Width/Length (in.)	Shelf Width/Length (mm)	Approx. Pkd. Wt. (lbs.) (kg)	Super Erecta Brite Finish		Chrome Finish	
			Two Swivel Two Brake Resilient Rubber Casters	Two Swivel Two Brake Polyurethane Casters	Two Swivel Two Brake Resilient Rubber Casters	Two Swivel Two Brake Polyurethane Casters
18x36	457x914	60 27	N336BBR	N336EBR	N336BC	N336EC
18x48	457x1219	72 32	N356BBR	N356EBR	N356BC	N356EC
18x60	457x1524	88 40	N366BBR	N366EBR	N366BC	N366EC
21x36	530x914	69 31	N436BBR	N436EBR	N436BC	N436EC
21x48	530x1219	81 36	N456BBR	N456EBR	N456BC	N456EC
21x60	530x1524	98 44	N466BBR	N466EBR	N466BC	N466EC
24x36	610x914	76 34	N536BBR	N536EBR	N536BC	N536EC
24x48	610x1219	92 41	N556BBR	N556EBR	N556BC	N556EC
24x60	610x1524	112 51	N566BBR	N566EBR	N566BC	N566EC

Note: Models with Resilient Rubber casters can hold up to 600 lbs. (272kg) evenly distributed. Models with Polyurethane casters can hold up to 900 lbs. (409kg) evenly distributed.

Stem Caster Carts — Solid — {11.10}

- Consist of four shelves, posts, plastic split sleeves, donut bumpers and 5" (127mm) poly casters (2 swivel; 2 brake).
- Strong and versatile
- Solid Shelf Stem Caster Carts feature a 1/8" (3mm) raised "ship's edge" around perimeter of shelves to help contain spillage.

With Four Galvanized Flat Shelves and Chrome-Plated Posts

63" (1600mm) Posts — Overall Height 67⁷/₈" (1724mm)



Solid Stem Caster with galvanized shelves

Shelf Width/Length (in.)	Shelf Width/Length (mm)	Approx. Pkd. Wt. (lbs.) (kg)	Cat. No.
24x36	610x914	100 45	F536EG
24x48	610x1219	124 56	F556EG
24x60	610x1524	152 69	F566EG

Note: Models are designed to hold up to 900 lbs. (363kg) evenly distributed.

Super Erecta Trucks — With Super Erecta Chrome Wire Shelves — 63" (1600mm) Plated Posts and Aluminum Dolly

Consists of four shelves, posts, plastic split sleeves, donut bumpers and 5" (127mm), resilient rubber or poly casters as designated.

Shelf Width/Length (in.) (mm)	Approx. Pkd. Wt. (lbs.) (kg)	Catalog Number with Casters		
		Two B5DN Two B5DNB	Two B5P Two B5PB	Two 6P Set BL6P
24x36 610x914	96 43	N536JC	N536LC	N536MC
24x48 610x1219	118 53	N556JC	N556LC	N556MC
24x60 610x1524	142 64	N566JC	N566LC	N566MC

Overall heights: JC, LC models — 68⁷/₁₆" (1739mm), MC models — 70¹/₁₆" (1800mm).

- JC models: Standard swivel plate casters, two with brake; resilient rubber tread.
- LC models: Standard swivel plate casters, two with brake; polyurethane tread.
- MC models: Larger plate casters; two swivel; one swivel/brake set; polyurethane tread.



Super Erecta Wire Truck

Slanted Shelf Trucks and Carts — {31.05}

Shelves slope backwards 2" (51mm) to keep items from falling during transport. Standard-duty carts have four poly stem casters. Heavy-duty trucks are dolly mounted.

Width/Length (in.) (mm)	Height (in.) (mm)	No. Shelves	Castors	Description	Approx. Pkd. Wt. (lbs.) (kg)	Cat. No.
24x36 610x914	62 ¹ / ₁₆ 1577	3	2-BL6P, 2-6P	Heavy-Duty	140 63	AST35MC
24x48 610x1219	62 ¹ / ₁₆ 1577	3	2-BL6P, 2-6P	Heavy-Duty	162 72.4	AST55MC
24x60 610x1524	62 ¹ / ₁₆ 1577	3	2-BL6P, 2-6P	Heavy-Duty	187 84.1	AST65MC
24x36 610x914	59 ⁷ / ₈ 1521	3	4-Poly Casters	Standard-Duty	105 47.2	AST35DC
24x48 610x1219	59 ⁷ / ₈ 1521	3	4-Poly Casters	Standard-Duty	125 56.2	AST55DC
24x60 610x1524	59 ⁷ / ₈ 1521	3	4-Poly Casters	Standard-Duty	150 67.5	AST65DC

Additional Slanted Shelves

Width/Length (in.) (mm)	Approx. Pkd. Wt. (lbs.) (kg)	Cat. No. Chrome
24x36 610x914	13 6	SLT2436NC
24x48 610x1219	17 8	SLT2448NC
24x60 610x1524	22 10	SLT2460NC

Handles — {11.40}

Use on corresponding width Super Erecta units to provide additional maneuverability to dolly carts or stem caster carts. Aluminum split sleeves included for attaching to cart.

Length (in.) (mm)	Push Handles		Extended Handles	
	Cat. No. Chrome	Cat. No. Stainless	Cat. No. Chrome	Cat. No. Stainless
14 355	PH14NC	PH14NS	EH14NC	EH14NS
18 457	PH18NC	PH18NS	EH18NC	EH18NS
21 530	PH21NC	PH21NS	EH21NC	EH21NS
24 610	PH24NC	PH24NS	EH24NC	EH24NS
30 760	PH30NC		EH30NC	
36 914	PH36NC		EH36NC	

Note: Handles fit unit widths only. Extended handles add 6" (152.4mm) to length of unit.



Push Handle



Extended Handle



Standard-Duty Slanted Shelf Cart

Stem Casters — {11.20}

Use with Super Erecta posts and shelves (see pages 37 and 42) to create a mobile shelving unit to meet your special needs. Stem casters are shipped with donut bumper at no additional charge.



5LD



5MB



5MDBA



5MPB



5MPR



5PC



5PCB



5MDGSA



5MHTPB



5MHTNB

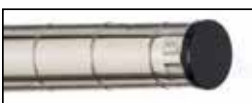

Swaged Post

Wheel Diameter (in.) (mm)	Face (in.) (mm)	Load Rating (lbs.) (kg)	Type	Wheel Tread	Temperature Range (Continuous Usage) (Fahrenheit) (Celsius)	Approx. Pkd. Wt. (lbs.) (kg)	Cat. No.
4 102	1/2 12	125 56	Stem/Swivel	Resilient Donut	-30°-160° -34°-71°	1 1/2 0.6	4LD
5 127	1/2 12	125 56	Stem/Swivel	Resilient Donut	-30°-160° -34°-71°	2 0.9	5LD
5 127	1/4 32	200 90	Stem/Swivel	Resilient, Flat	-30°-160° -34°-71°	2 1/2 1.1	5M
5 127	1/4 32	200 90	Stem/Brake	Resilient, Flat	-30°-160° -34°-71°	2 5/8 1.2	5MB
5 127	1/4 32	200 90	Stem/Rigid	Resilient, Flat	-30°-160° -34°-71°	3 1/2 1.5	5MR
5 127	1/4 32	250 113	Stem/Swivel	High Modulus Donut	-40°-180° -40°-82°	2 1/2 1.1	5MDBA
5 127	1/4 32	250 113	Stem/Brake	High Modulus Donut	-40°-180° -40°-82°	2 5/8 1.2	5MDBA
5 127	1/4 32	250 113	Stem/Rigid	High Modulus Donut	-40°-180° -40°-82°	2 3/8 1.1	5MDRA
5 127	1/4 32	300 135	Stem/Swivel	Polyurethane, Flat	-30°-180° -34°-82°	2 1/8 0.9	5MP
5 127	1/4 32	300 135	Stem/Brake	Polyurethane, Flat	-30°-180° -34°-82°	2 1/4 1	5MPB
5 127	1/4 32	300 135	Stem/Rigid	Polyurethane, Flat	-30°-180° -34°-82°	2 0.9	5MPR
6 152	1/2 38	400 182	Stem/Swivel	Polyurethane, Flat	-30°-180° -34°-82°	2 1/4 1.1	6MP
6 152	1/2 38	400 182	Stem/Brake	Polyurethane, Flat	-30°-180° -34°-82°	2 1/2 0.9	6MPB
6 152	1/2 38	400 182	Stem/Rigid	Polyurethane, Flat	-30°-180° -34°-82°	2 1/4 1	6MPR

Note 1: Rigid casters are held in place by a connecting channel. When ordering, shelf width must be provided. Rigid connecting channel (stainless steel): Cat. No. 14RS, 18RS, 21RS, 24RS, 30RS, or 36RS.

Note 2: Load Height for all 5M and 5MP casters — 6 3/32" ± 1/16" (155 ± 1.5mm).

Note 3: Load Height for 4LD caster — 4 5/8" ± 1/16" (118 ± 1.5mm).

Note 4: Load Height for 5LD caster — 5 5/8" ± 1/16" (143 ± 1.5mm).

Note 5: Brakes are foot-operated.

Rigid stem casters are often ordered two per unit for improved tracking and handling. Rigid caster channels are provided with each two rigid stem casters at no charge.

Polymer Casters — {11.20}

Innovative polymer stem casters offer corrosion resistance and enhanced durability. Appropriate for all medium-duty mobile applications. Donut bumpers included.

- All-polymer horn, stainless axle, and hardware.
- 5" (127mm) diameter polyurethane, flat wheel tread.
- Sleeve style axle bearing and optional toe-operated brake mechanism

Wheel Diameter (in.) (mm)	Face (in.) (mm)	Load Rating (lbs.) (kg)	Type	Wheel Tread	Temperature Range (Continuous Usage) (Fahrenheit) (Celsius)	Approx. Pkd. Wt. (lbs.) (kg)	Cat. No.	Cat. No. Antimicrobial
5 127	1/4 32	300 135	Stem/Swivel	Polyurethane, Flat	-20°-120° -29°-49°	2 0.9	5PC	5PCM
5 127	1/4 32	300 135	Stem/Brake	Polyurethane, Flat	-20°-120° -29°-49°	2 0.9	5PCB	5PCBM
5 127	1/4 32	300 135	Stem/Rigid	Polyurethane, Flat	-20°-120° -29°-49°	2 0.9	5PCR	

Note 1: Rigid casters are held in place by a connecting channel. When ordering, shelf width must be provided. Rigid connecting channel (aluminum) for 5PCR casters: Cat. No. P14RC, P18RC, P21RC, P24RC, P30RC, or P36RC.

Note 2: Not suitable for cart wash and autoclave applications.

Stainless Steel Cart-Washable Stem Casters — {11.20}

Stem casters are shipped with donut bumpers at no extra charge.

Wheel Diameter (in.) (mm)	Face (in.) (mm)	Load Rating (lbs.) (kg)	Type	Wheel Tread	Temperature Range (Continuous Usage) (Fahrenheit) (Celsius)	Approx. Pkd. Wt. (lbs.) (kg)	Cat. No.
5 127	1/4 32	250 113	Stem/Swivel	High Modulus Donut	-40°-180° -40°-82°	2 1/2 1.1	5MDGSA
5 127	1/4 32	250 113	Stem/Brake	High Modulus Donut	-40°-180° -40°-82°	2 5/8 1.2	5MDBGSA
5 127	1/4 32	250 113	Stem/Rigid	High Modulus Donut	-40°-180° -40°-82°	2 3/8 1.1	5MDRGSA
5 127	1/4 32	300 135	Stem/Swivel	Polyurethane, Flat	-30°-180° -34°-82°	2 1/8 0.9	5MPGSA
5 127	1/4 32	300 135	Stem/Brake	Polyurethane, Flat	-30°-180° -34°-82°	2 1/4 1	5MPBGSA
5 127	1/4 32	300 135	Stem/Rigid	Polyurethane, Flat	-30°-180° -34°-82°	2 0.9	5MPRGSA

Note 1: Rigid casters are held in place by a connecting channel. When ordering, shelf width must be provided. Rigid connecting channel (stainless steel): Cat. No. 14RS, 18RS, 21RS, 24RS, 30RS, or 36RS.

Note 2: Load Height for all 5MD and 5MP casters — 6 3/32" ± 1/16" (155 ± 1.5mm).

Note 3: All casters are grease sealed with zerk fittings in swivel and axle.

Note 4: Brakes are foot-operated.

High-temperature Autoclave Stem Casters

Wheel Diameter (in.) (mm)	Face (in.) (mm)	Load Rating (lbs.) (kg)	Type	Wheel Tread	Temperature Range (Continuous Usage) (Fahrenheit) (Celsius)	Approx. Pkd. Wt. (lbs.) (kg)	Cat. No.
5 127	1/2 38	300 135	Stem/Swivel	Phenolic, Flat	-45°-475° -43°-250°	2 1/5 1	5MHTP
5 127	1/2 38	300 135	Stem/Brake	Phenolic, Flat	-45°-475° -43°-250°	2 1/5 1.3	5MHTPB
5 127	1/2 38	300 135	Stem/Swivel	Nylon, Flat	-20°-475° -29°-250°	2 2/5 1.1	5MHTN
5 127	1/2 38	300 135	Stem/Brake	Nylon, Flat	-20°-475° -29°-250°	3 1.4	5MHTNB

Swaged Posts — For cart wash and autoclave applications

Each Type 304 stainless post has an aluminum cap swaged into the top of the post. For use with standard stem casters.

Description	Dimensions		Cat. No.
	(in.)	(mm)	
Stem Caster Post	33	875	33UPS-SW
Stem Caster Post	54	1370	54UPS-SW
Stem Caster Post	63	1600	63UPS-SW

Note: For special height posts, please consult your Metro representative.

☑ Indicates antimicrobial product.

Low Profile 3" Casters — {11.20}

Ideal for creating shorter height mobile units for undercounter use. Threaded stem fits stationary posts with threaded base. (Remove leveling foot and install caster)



3TM



3TMB

Wheel Diameter (in.) (mm)	Face (in.) (mm)	Load Rating (lbs.) (kg)	Type	Wheel Thread	Temperature Range (Continuous Usage) (Fahrenheit) (Celsius)	Approx. Pkd. Wt. (lbs.) (kg)	Cat. No.
3 76	15/16 24	100 45	Threaded Stem, Swivel	Resilient Rubber	-30° - 160° -34° - 71°	1.0 .45	3TM
3 76	15/16 24	100 45	Threaded Stem, Swivel/Brake	Resilient Rubber	-30° - 160° -34° - 71°	1.1 .50	3TMB

Note 1: Not intended for carts that travel long distances.



Donut Bumper

Donut Bumpers — {11.40}

- Non-phthalate, flexible vinyl material

Diameter (in.) (mm)	Height (lbs.) (kg)	Cat. No.
3 1/2 89	3/4 19	9992DB*
5 1/2 140	1 3/16 21	9992N

*Included with each Super Erecta stem caster as noted on previous page.

Decorative Casters — {10.06}

- Black nylon housing with non-marking polymer tread.
- 2 1/2" (63mm) models have threaded stem and attach to stationary shelving posts.
- 4" (100mm) casters include threaded insert for use with mobile posts.



HDC5B

HDC5BB

Type	Diameter (in.) (mm)	Fits Post Type	Cat. No.
Swivel/Brake	2 1/2 63	Stationary	HDC3BB
Swivel	4 100	Mobile	HDC5B
Swivel/Brake	4 100	Mobile	HDC5BB

Castors shipped with post inserts (as shown left) for adaptability to mobile posts.

The following information is to assist you in the selection of the appropriate caster for your specific application. Remember, the selection of the proper caster is determined by the load requirements, the operating environment, and other special conditions.

Wheel Material	Resistance to Oil & Grease	Rollability	Floor Protection	Noise
Resilient Rubber	LOW	FAIR	GOOD	LOW
Neoprene	HIGH	GOOD	GOOD	LOW
Polyurethane	HIGH	GOOD	GOOD	MODERATE
High-Modulus Rubber	HIGH	GOOD	GOOD	LOW
Conductive	LOW	FAIR	GOOD	LOW

Caster Tips:

1. The total weight of the equipment and its load should not exceed three times the load rating per caster.
2. Given the same wheel material, the larger the wheel diameter, the greater the load capacity and the better the rollability.
3. Caster mounting patterns affect maneuverability and steering of the equipment.

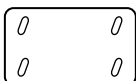

For maneuverability, use 4 swivel casters.

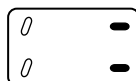

For steering control use 2 swivel and 2 rigid casters.

4. Plate casters generally have wheels of larger diameter and can usually carry more weight and take more abuse than stem casters.
5. Ball bearings and roller bearings in the wheel generally perform better and carry more weight than engineered plastic bearings or sintered metal bearings. Metro stem casters in the SMP and the 5MDA series have ball bearings in the swivel and the wheel. Most plate casters have ball bearings in the swivel and ball or roller bearings in the wheel.
6. Wheel tread shapes are generally flat, rounded or tapered. Tapered wheels, like donut-shaped wheels, tend to roll more easily. High-modulus donut wheels offer resiliency and mobility, reduce noise, and absorb shock on uneven or rough floors.

Additional stem and plate casters, in various sizes, are available.

SUPER ERECTA® DOLLIES



Made-to-Order Truck Dollies (Aluminum)* — {11.37}

Select the desired dolly size from the chart below and combine with the desired plate casters found on page 53.

The caster plate style must be specified at the time of order — “B” or “C” plate. The dollies are modified at the factory prior to shipment. For example, D2448NCB, four #B5P = one aluminum dolly frame with four 5” B-plate swivel polyurethane casters designed to accommodate nominal 24” x 48” (610 x 1219mm) shelves.



Dolly Frame

Metro Fact:

Metro dolly frames and stock truck dollies add 3 1/8" (78mm) to the length of the unit and 3 3/8" (87mm) to the unit width.

Stainless steel frames and staked posts are recommended for heavy-duty applications.

Truck Dolly Frames

Shelf Width/Length (in.)	Shelf Width/Length (mm)	ALUMINUM		STAINLESS	
		Cat. No. with Corner Bumper	Cat. No. with Wraparound Bumper	Cat. No. with Corner Bumper	Cat. No. with Wraparound Bumper
18x24	457x610	D1824NCB	D1824NP	D1824SCB	D1824SP
18x30	457x760	D1830NCB	D1830NP	D1830SCB	D1830SP
18x36	457x914	D1836NCB	D1836NP	D1836SCB	D1836SP
18x42	457x1066	D1842NCB	D1842NP	D1842SCB	D1842SP
18x48	457x1219	D1848NCB	D1848NP	D1848SCB	D1848SP
18x60	457x1524	D1860NCB	D1860NP	D1860SCB	D1860SP
18x72	457x1825	D1872NCB	D1872NP	D1872SCB	D1872SP
21x24	530x610	D2124NCB	D2124NP	D2124SCB	D2124SP
21x30	530x760	D2130NCB	D2130NP	D2130SCB	D2130SP
21x36	530x914	D2136NCB	D2136NP	D2136SCB	D2136SP
21x42	530x1066	D2142NCB	D2142NP	D2142SCB	D2142SP
21x48	530x1219	D2148NCB	D2148NP	D2148SCB	D2148SP
21x60	530x1524	D2160NCB	D2160NP	D2160SCB	D2160SP
21x72	530x1825	D2172NCB	D2172NP	D2172SCB	D2172SP
24x24	610x610	D2424NCB	D2424NP	D2424SCB	D2424SP
24x30	610x760	D2430NCB	D2430NP	D2430SCB	D2430SP
24x36	610x914	D2436NCB	D2436NP	D2436SCB	D2436SP
24x42	610x1066	D2442NCB	D2442NP	D2442SCB	D2442SP
24x48	610x1219	D2448NCB	D2448NP	D2448SCB	D2448SP
24x60	610x1524	D2460NCB	D2460NP	D2460SCB	D2460SP
24x72	610x1825	D2472NCB	D2472NP	D2472SCB	D2472SP

*Note 1: "Made To Order Dollies" are non-returnable and orders are non-cancelable.

Note 2: Replacement wraparound bumper kits are available. See your Metro representative for details.

Note 3: Maximum load capacity for dollies is 1,000 lbs. (454kg), depending on caster selection.

Stock Truck Dollies — {11.36}

These are aluminum dollies with a single catalog number for frame and casters with wraparound bumper. Use with Super Erecta Shelving and posts to create mobile carts for higher weight capacities. See specific plate caster load ratings (page 53) to determine appropriate stock truck dolly.



Stock Dolly

Shelf Width/Length (in.)	Shelf Width/Length (mm)	Castors	Cat. No.
24x36	610x914	Two B5DN/Two B5DNB	D53JN
24x48	610x1219	Two B5DN/Two B5DNB	D55JN
24x60	610x1524	Two B5DN/Two B5DNB	D56JN
24x36	610x914	Two 6P/Two BL6P	D53MN
24x48	610x1219	Two 6P/Two BL6P	D55MN
24x60	610x1524	Two 6P/Two BL6P	D56MN
24x48	610x1219	Two 8P/Two BL8P	D55PN
24x60	610x1524	Two 8P/Two BL8P	D56PN
24x48	610x1219	Two C8DA/Two C8DSL A*	D55PSLN
24x60	610x1524	Two C8DA/Two C8DSL A*	D56PSLN

*Swivel Lock.

Note: Replacement wraparound bumper kits are available. See your Metro representative for details.

Staked Posts — For use with Truck Dollies — {10.01}

Each post connects to a truck dolly through the stem receptacle. The stem receptacles are staked into the bottom of these posts to ensure a durable connection in abusive applications.



Staked Post

Height* (in.)	Height* (mm)	Approx. Pkd. Wt. (lbs.)	Approx. Pkd. Wt. (kg)	Cat. No. Chrome	Cat. No. Stainless
54 ⁹ / ₁₆	1385	3	1.4	54P-STKD	54PS-STKD
62 ⁹ / ₁₆	1590	3 1/2	1.6	63P-STKD	63PS-STKD
74 ⁵ / ₈	1895	4	1.8	74P-STKD	74PS-STKD

*Height includes leveling bolt and cap.

Pitched Aluminum Dust Cover — {11.37}

For "Made-To-Order" dollies, these covers act as a barrier between the floor and the bottom shelf of cart for cleanliness. These covers are factory-assembled and must be ordered with desired dolly frame.

Width/Length (in.)	Width/Length (mm)	Approx. Pkd. Wt. (lbs.)	Approx. Pkd. Wt. (kg)	Cat. No.
24x36	610x914	7	3.2	DCT2436N
24x42	610x1066	7	3.2	DCT2442N
24x48	610x1219	8	3.6	DCT2448N
24x60	610x1524	8	3.6	DCT2460N
24x72	610x1825	8	3.6	DCT2472N



Pitched Aluminum Dust Cover

Plate Casters — {11.37}

Use in conjunction with Metro “Made-to-Order” truck dollies to assemble a heavy-duty mobile base for your needs. Important: The caster plate style must be specified at the time of order — “B” or “C” plate. The dollies are modified at the factory prior to shipment.

Top view of caster plates

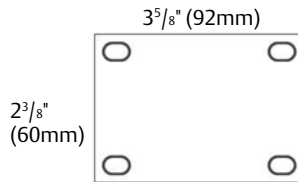

B-plate casters offer good impact resistance for common thresholds.

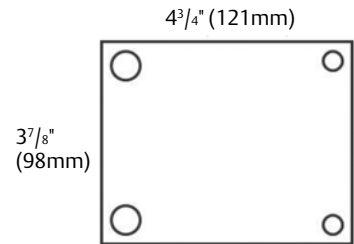

C-plate casters offer the thickest metal chassis and largest wheels for the most abusive conditions and heaviest storage loads.

Diameter (in.) (mm)	Wheel Face (in.) (mm)	Load Rating (lbs.) (kg)	Weight Each (lbs.) (kg)	Type	Wheel Tread	Cat. No.	
5	125	1 ³ / ₈ 35	225 101	2 ¹ / ₈ .99	Swivel	Donut Neoprene	B5DN
5	125	1 ³ / ₈ 35	225 101	2 ¹ / ₄ 1	Brake	Donut Neoprene	B5DNB
5	125	1 ³ / ₈ 35	225 101	2 .9	Rigid	Donut Neoprene	B5DNR
5	125	1 ¹ / ₄ 31	300 135	2 ¹ / ₈ .99	Swivel	Polyurethane	B5P
5	125	1 ¹ / ₄ 31	300 135	2 ¹ / ₄ 1	Brake	Polyurethane	B5PB
5	125	1 ¹ / ₄ 31	300 135	2 .9	Rigid	Polyurethane	B5PR
6	152	2 51	400 181	8 3.63	Swivel	Hi-Modulus Donut	C6DA
6	152	2 51	400 181	8 3.63	Swivel/Brake	Hi-Modulus Donut	C6DBA
6	152	2 51	400 181	8 3.63	Rigid	Hi-Modulus Donut	C6DRA
6	152	2 51	400 181	8 3.63	Swivel/Lock	Hi-Modulus Donut	C6DSL A
8	203	2 51	450 204	9 4.08	Swivel	Hi-Modulus Donut	C8DA
8	203	2 51	450 204	9 4.08	Swivel/Brake	Hi-Modulus Donut	C8DBA
8	203	2 51	450 204	9 4.08	Rigid	Hi-Modulus Donut	C8DRA
8	203	2 51	450 204	9 4.08	Swivel/Lock	Hi-Modulus Donut	C8DSL A
6	150	2 51	500 225	4 ³ / ₄ 2.1	Swivel	Polyurethane	C6P
6	150	2 51	500 225	4 ⁷ / ₈ 2.2	Brake	Polyurethane	C6PB
6	150	2 51	500 225	3 ¹ / ₂ 1.6	Rigid	Polyurethane	C6PR
6	150	2 51	500 225	5 2.3	Swivel/Lock	Polyurethane	C6PS/L-LH
8	200	2 51	700 315	5 ³ / ₄ 2.6	Swivel	Polyurethane	C8P
8	200	2 51	700 315	5 ⁷ / ₈ 2.65	Brake	Polyurethane	C8PB
8	200	2 51	700 315	4 ¹ / ₂ 2	Rigid	Polyurethane	C8PR
8	200	2 51	700 315	6 2.7	Swivel/Lock	Polyurethane	C8PS/L-LH
8	200	2 51	280 127	8 3.6	Swivel	Semi-Pneumatic Style	C8SPN
8	200	2 51	280 127	8 ¹ / ₂ 3.8	Swivel/Brake	Semi-Pneumatic Style	C8SPNB
8	200	2 51	280 128	8 3.6	Rigid	Semi-Pneumatic Style	C8SPNR

Note 1: Brakes are foot-operated.

Note 2: 8" (200mm) casters should not be used on units less than 21" (530mm) wide.

Note 3: Swivel lock casters are set diagonally on the left-hand sides when dolly mounted.

Load Heights: ($\pm 1/16$ ") (± 1.6 mm) B5 Series — 6¹/₄" (159mm), C6 Series — 7¹/₂" (190mm), C8 Series — 9¹/₂" (241mm), 8S Series — 9¹/₂" (241mm)



B5DNB with Wheel Brake



B5P Polyurethane



C8SPN Semi-Pneumatic Style "Flat-Free"



B5PGSA

Stainless Steel Cart-Washable Plate Casters — {11.37}

Wheel Diameter (in.) (mm)	Face (in.) (mm)	Load Rating (lbs.) (kg)	Weight Each (lbs.) (kg)	Type	Wheel Tread	Cat. No.	
5	125	1 ¹ / ₄ 31	300 135	2 ¹ / ₈ .99	Swivel	Polyurethane	B5PGSA
5	125	1 ¹ / ₄ 31	300 135	2 ¹ / ₄ 1	Brake	Polyurethane	B5PBGSA
5	125	1 ¹ / ₄ 31	300 135	2 .9	Rigid	Polyurethane	B5PRGSA
6	150	1 ¹ / ₂ 38	600 270	4 ³ / ₄ 2.1	Swivel	Polyurethane	C6PGSA
6	150	1 ¹ / ₂ 38	600 270	4 ⁷ / ₈ 2.2	Brake	Polyurethane	C6PBGSA

See above notes for important specification information.

General Guidelines for Metro Carts Used in Over-the-Road Applications

For applications where carts are loaded on to or off of trucks for transportation, and/or where thresholds exceeding $3/8$ " in height are repeatedly encountered:

- A dolly is recommended for maximum useful life.

- Casters of at least 6" diameter are recommended. Consideration should be given to the shock absorbing ability of the caster wheel, but selection will need to be based upon the specifics of the application.
- Aluminum split sleeves and staked posts should be used.

- Weight load should be limited to approximately 750 lbs. depending on the specifics of the application. Consult your Metro representative with the details of the Over-the-Road application. Each application is unique, and the preceding points are intended only as general guidelines.

See page 51 for additional specifications and appropriate parameters for all types of Metro casters.

Brake Lock/Swivel Lock Combination Casters — {11.70}

Patented, foot-operated design enables a single pair of casters to serve as swivel, rigid or brake casters. Conveniently positioned on the dolly, not on the wheels, the downward pressure pedals prevent scuffing of shoes.



Brake Lock/Swivel Lock combination casters

- **How It Works**
Brake lock/swivel lock caster sets are operated by two separate foot pedals. One pedal locks the two wheels in a rigid position or releases them to swivel; the other pedal engages and releases brakes on the same two wheels.
- **Convenient**
Pedals are on the dolly, not the wheels, making operation more convenient. Downward pressure on the pedals save shoes from scuffing.
- **Casters**
Long wearing polyurethane. Resists abrasion. Non-marking, shock absorbing. Wheels are available in 6" (152mm) and 8" (203mm) size.
- **Recommended Caster Selection**
Two swivel casters at one end and brake/swivel lock set at the other end. Other caster combinations can be used, however, including brake/swivel lock sets at both ends. Wraparound bumper recommended.

Type	Wheel Diameter (in.) (mm)		Face (in.) (mm)		For Use With	Load Rating (lbs.) (kg)		Weight (lbs.) (kg)		Cat. No.
*Brake/Lock	6	152	2	51	24" (610mm) Deep Dolly and 6P Caster	600	272	7 ¹ / ₄	3.3	BL6P24
*Brake/Lock	8	203	2	51	24" (610mm) Deep Dolly and 8P Caster	600	272	9	4.1	BL8P24
Swivel	6	152	2	51	BL6P24 Brake/Lock Set	600	272	5 ¹ / ₄	2.3	6P
Rigid	6	152	2	51	6P Swivel Caster	600	272	5	2.26	6PR
Swivel	8	203	2	51	BL8P24 Brake/Lock Set	600	272	6 ¹ / ₂	2.9	8P
Rigid	8	203	2	51	8P Swivel Caster	600	272	6	2.7	8PR

*Above part numbers include the brake/lock mechanism with two casters. Order dolly separately (see page 52). In addition order either two 6P or two 8P casters.
Example: (1) D2436NP and (1) BL6P24 or (1) BL8P24 and two 6P or two 8P.

Note: Not compatible on security units.

Load Heights: (±1/16") (±1.6mm) 6P Series — 7⁷/₈" (200mm), 8P Series — 9¹³/₁₆" (249mm).



Tow Bar Assembly

Tow Bar Assembly — {11.70}

Attaches to underside of dolly to facilitate transport of dolly carts in tandem. Must be factory assembled and ordered with desired dolly frame (see page 52).

Length (in.) (mm)	Cat. No.
48 1219	TBA48

Note: "C" plate caster must be used with Tow Bar Assembly. Tow Bar Assembly for use with 24" (610mm) units only.

Note: Number of carts to be towed, weight on carts, and towing route affect operation of tow bar assembly. **Before ordering, contact your Metro representative.**

Tow Bar Assembly not appropriate for use with Brake Lock/Swivel Lock system.



Push Handle

Handles — {11.40}

Use on corresponding width Super Erecta units to provide additional maneuverability to dolly carts or stem caster carts. Aluminum split sleeves included for attaching to cart.

Length (in.) (mm)	Push Handles		Extended Handles	
	Cat. No. Chrome	Cat. No. Stainless	Cat. No. Chrome	Cat. No. Stainless
14 355	PH14NC	PH14NS	EH14NC	EH14NS
18 457	PH18NC	PH18NS	EH18NC	EH18NS
21 530	PH21NC	PH21NS	EH21NC	EH21NS
24 610	PH24NC	PH24NS	EH24NC	EH24NS
30 760	PH30NC		EH30NC	
36 914	PH36NC		EH36NC	

Note: Handles fit unit widths only. Extended handles add 6" (152.4mm) to length of unit.



Extended Handle

Shelf Dividers for Super Erecta Shelves — {10.04}

Keep shelf contents orderly with these 8" (203mm) high, pressure-fit dividers.

Shelf Width (in.) (mm)	Approx. Pkd. Wt. (lbs.) (kg)	Cat. No. Plated	Cat. No. Black	Cat. No. White	Cat. No. Smoked Glass
14 355	1.8 0.8	DD14C	DD14BL	DD14W	DD14-DSG
18 457	2.25 1.0	DD18C	DD18BL	DD18W	DD18-DSG
21 530	2.5 1.1	DD21C	DD21BL	DD21W	DD21-DSG
24 610	2.75 1.3	DD24C	DD24BL	DD24W	DD24-DSG
30 760	3.25 1.5	DD30C	DD30BL	DD30W	DD30-DSG
36 914	3.75 1.7	DD36C	DD36BL	DD36W	DD36-DSG

Shelf Width (in.) (mm)	Approx. Pkd. Wt. (lbs.) (kg)	Cat. No. Metroseal 3 with Microban®	Cat. No. Stainless	Cat. No. Designer Colors
14 355	1.8 0.8	DD14K3	DD14S	DD14-D
18 457	2.25 1.0	DD18K3	DD18S	DD18-D
21 530	2.5 1.1	DD21K3	DD21S	DD21-D
24 610	2.75 1.3	DD24K3	DD24S	DD24-D
30 760	3.25 1.5		DD30S	
36 914	3.75 1.7		DD36S	



Shelf Divider for Super Erecta Shelves

Universal 8" (203mm) Shelf Dividers — Light Duty — {9.25}

Each divider includes a panel and two clips to connect to any Super Erecta or Super Adjustable wire self. Corrosion proof.

Nominal Length (in.) (mm)	Fits Shelf Depth	Approx. Pkd. Wt. (lbs.) (kg)	Cat. No.
18 457	18", 21" (457, 530mm)	1.3 0.6	MUD18-8
24 610	24" (610mm)	1.6 0.7	MUD24-8

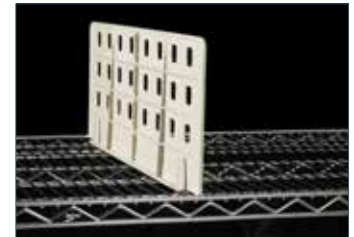

Universal Shelf Divider

Shelf Ledges — Side and Back — {10.04}

For stationary or mobile installations, ledges prevent items from protruding or falling from shelves.

1" (25mm) High Ledges

Length (in.) (mm)	Approx. Pkd. Wt. (lbs.) (kg)	Cat. No. Plated	Cat. No. Black	Cat. No. White	Cat. No. Smoked Glass	Cat. No. Stainless	Cat. No. Designer Colors†
14 355	0.58 0.25	L14N-1C	L14N-1BL	L14N-1W	L14N-1-DSG	L14N-1S	L14N-1-D
18 457	0.75 0.33	L18N-1C	L18N-1BL	L18N-1W	L18N-1-DSG	L18N-1S	L18N-1-D
21 530	0.75 0.33	L21N-1C	L21N-1BL	L21N-1W	L21N-1-DSG	L21N-1S	L21N-1-D
24 610	1.0 0.45	L24N-1C	L24N-1BL	L24N-1W	L24N-1-DSG	L24N-1S	L24N-1-D
30 760	2.0 0.9	L30N-1C	L30N-1BL	L30N-1W	L30N-1-DSG	L30N-1S	L30N-1-D
36 914	2.5 1.13	L36N-1C	L36N-1BL	L36N-1W	L36N-1-DSG	L36N-1S	L36N-1-D
42 1066	2.75 1.25	L42N-1C	L42N-1BL	L42N-1W	L42N-1-DSG	L42N-1S	L42N-1-D
48 1219	3.5 1.58	L48N-1C	L48N-1BL	L48N-1W	L48N-1-DSG	L48N-1S	L48N-1-D
54 1370	4.4 1.65	L54N-1C	L54N-1BL	L54N-1W	L54N-1-DSG	L54N-1S	L54N-1-D
60 1524	3.75 1.68	L60N-1C	L60N-1BL	L60N-1W	L60N-1-DSG	L60N-1S	L60N-1-D
72 1828	4.0 1.81	L72N-1C	L72N-1BL	L72N-1W	L72N-1-DSG	L72N-1S	L72N-1-D

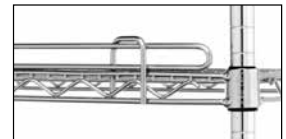

1" (25mm) Ledge



4" (102mm) Ledge

4" (100mm) High Stackable Ledges

Shelf Width (in.) (mm)	Approx. Pkd. Wt. (lbs.) (kg)	Cat. No. Plated	Cat. No. Black	Cat. No. White	Cat. No. Smoked Glass	Cat. No. Metroseal 3 with Microban®	Cat. No. Stainless	Cat. No. Designer Colors†
14 355	0.83 0.36	L14N-4C	L14N-4BL	L14N-4W	L14N-4-DSG	L14N-4K3	L14N-4S	L14N-4-D
18 457	1.5 0.68	L18N-4C	L18N-4BL	L18N-4W	L18N-4-DSG	L18N-4K3	L18N-4S	L18N-4-D
21 530	1.75 0.71	L21N-4C	L21N-4BL	L21N-4W	L21N-4-DSG	L21N-4K3	L21N-4S	L21N-4-D
24 610	2.0 0.9	L24N-4C	L24N-4BL	L24N-4W	L24N-4-DSG	L24N-4K3	L24N-4S	L24N-4-D
30 760	2.25 1.03	L30N-4C	L30N-4BL	L30N-4W	L30N-4-DSG	L30N-4K3	L30N-4S	L30N-4-D
36 914	2.75 1.25	L36N-4C	L36N-4BL	L36N-4W	L36N-4-DSG	L36N-4K3	L36N-4S	L36N-4-D
42 1066	3.25 1.48	L42N-4C	L42N-4BL	L42N-4W	L42N-4-DSG	L42N-4K3	L42N-4S	L42N-4-D
48 1219	3.75 1.68	L48N-4C	L48N-4BL	L48N-4W	L48N-4-DSG	L48N-4K3	L48N-4S	L48N-4-D
54 1370	3.8 1.73	L54N-4C	L54N-4BL	L54N-4W	L54N-4-DSG	L54N-4K3	L54N-4S	L54N-4-D
60 1524	4.0 1.81	L60N-4C	L60N-4BL	L60N-4W	L60N-4-DSG	L60N-4K3	L60N-4S	L60N-4-D
72 1828	5.0 2.25	L72N-4C	L72N-4BL	L72N-4W	L72N-4-DSG	L72N-4K3	L72N-4S	L72N-4-D

Note: Actual ledge length is approximately 1" (25mm) shorter than nominal shelf length/width.

† Contact your Metro representative for pricing on Designer Color Ledges.

🔴 Indicates antimicrobial product.



Enclosure Panel

Enclosure Panels — {10.04} {10.30}

An efficient way to enclose space for stationary or mobile applications.

- Can be used with Super Erecta® and Super Adjustable wire shelving, and Super Erecta solid shelving.
- Appropriate mounting hardware supplied with each panel for stationary applications.

Width/Height (in.) (mm)		For Nominal Post Height (in.) (mm)		Grid Opening (in.) (mm)		Weight (lbs.) (kg)		Cat. No. Chrome	Cat. No. Stainless
12 ³ / ₈ x50 ³ / ₄	313x1289	54	1370	2 ⁷ / ₈ x3 ⁵ / ₈	73x92	3	1.4	EP35C	EP35S
12 ³ / ₈ x59 ³ / ₄	313x1518	63	1600	2 ⁷ / ₈ x3 ⁵ / ₈	73x92	4	1.8	EP36C	EP36S
12 ³ / ₈ x70 ¹ / ₂	313x1791	74	1880	2 ⁷ / ₈ x3 ⁵ / ₈	73x92	6	2.7	EP37C	EP37S
18 ³ / ₈ x50 ³ / ₄	464x1289	54	1370	3 ³ / ₈ x3 ⁵ / ₈	86x92	5	2.3	EP55C	EP55S
18 ³ / ₈ x59 ³ / ₄	464x1518	63	1600	3 ³ / ₈ x3 ⁵ / ₈	86x92	6	2.7	EP56C	EP56S
18 ³ / ₈ x70 ¹ / ₂	464x1791	74	1800	3 ³ / ₈ x3 ⁵ / ₈	86x92	7	3.2	EP57C	EP57S

All panels are 7/8" (22mm) deep.

Note: Units with a solid shelf in the top position require the use of a three-sided double snake frame directly below it (see page 57).

Ordering Guide for Enclosure Panels

Super Erecta and Super Adjustable Wire Shelving Units Super Erecta Solid Shelving Units

Ends — Panels required for each end according to shelf width, as follows:

Nominal Post Height (in.) (mm)	18" (457mm) Nominal Shelf Width	21" (530mm) Nominal Shelf Width	24" (610mm) Nominal Shelf Width	30" (760mm) Nominal Shelf Width	36" (914mm) Nominal Shelf Width
54 1370	(1) EP35	(1) EP35	(1) EP55	(2) EP35	(1) EP35
63 1600	(1) EP36	(1) EP36	(1) EP56	(2) EP36	(1) EP36
74 1880	(1) EP37	(1) EP37	(1) EP57	(2) EP37	(1) EP37

Backs — Requires multiple panels in quantities shown for specific length shelf:

For Wire Shelves:

Nominal Post Height (in.) (mm)	30" (760mm) Nominal Shelf Length	36" (914mm) Nominal Shelf Length	42" (1066mm) Nominal Shelf Length	48" (1219mm) Nominal Shelf Length	54" (1370mm) Nominal Shelf Length	60" (1524mm) Nominal Shelf Length	72" (1825mm) Nominal Shelf Length
54 1370	(2) EP35	(1) EP35 (1) EP55	(2) EP55	(2) EP35 (1) EP55	(1) EP35 (2) EP55	(3) EP55	(1) EP35 (3) EP55
63 1600	(2) EP36	(1) EP36 (1) EP56	(2) EP56	(2) EP36 (1) EP56	(1) EP36 (2) EP56	(3) EP56	(1) EP36 (3) EP56
74 1880	(2) EP37	(1) EP37 (1) EP57	(2) EP57	(2) EP37 (1) EP57	(1) EP37 (2) EP57	(3) EP57	(1) EP37 (3) EP57

For Solid Shelves*:

Nominal Post Height (in.) (mm)	30" (760mm) Nominal Shelf Length	36" (914mm) Nominal Shelf Length	42" (1066mm) Nominal Shelf Length	48" (1219mm) Nominal Shelf Length	54" (1370mm) Nominal Shelf Length	60" (1524mm) Nominal Shelf Length	72" (1825mm) Nominal Shelf Length
54 1370	(1) EP55	(2) EP35	(1) EP35 (1) EP55	(2) EP55	N/A N/A	(1) EP35 (2) EP55	N/A N/A
63 1600	(1) EP56	(2) EP36	(1) EP36 (1) EP56	(2) EP56	N/A N/A	(1) EP36 (2) EP56	N/A N/A
74 1880	(1) EP57	(2) EP37	(2) EP37 (1) EP57	(2) EP57	N/A N/A	(1) EP37 (2) EP57	N/A N/A

*Note: Units with a solid shelf in the top position require the use of a three-sided double snake frame directly below it (see page 57).



Super Adjustable Super Erecta Cart with Enclosure Panels

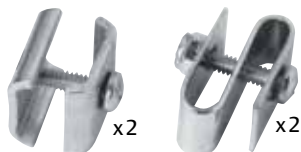

Mounting Kit for Enclosure Panel

Hardware Kit for Mobile Applications

It is recommended that additional clamp assemblies are used to secure the enclosure panels to the intermediate shelves on a mobile unit or transport cart. For the most abusive mobile applications, use two clamp assemblies at each intermediate shelf level for each enclosure panel.

Plated steel. Cat. No. **9970Z** Kit of 8 clamp assemblies
Stainless steel. Cat. No. **9970S** Kit of 8 clamp assemblies

Replacement Mounting Kit for Enclosure Panel

Kit includes two security S-hooks and two clamp assemblies.

Plated steel. Cat. No. **9970EPZ**
Stainless steel. Cat. No. **9970EPS**

Shelf-to-Shelf Dividers — {9.25}

Full height dividers efficiently compartmentalize the space between two shelves. Corrosion proof. Compatible with Super Erecta and Super Adjustable wire shelves.

Fits Shelf Depth		Nominal Height		Approx. Pkd. Wt.		Cat. No.
(in.)	(mm)	(in.)	(mm)	(lbs.)	(kg)	
18, 21	457, 530	16	406	2.3	1.0	MD18-16
18, 21	457, 530	20	508	2.5	1.1	MD18-20
18, 21	457, 530	24	610	3.8	1.7	MD18-24
24	610	16	406	2.8	1.2	MD24-16
24	610	20	508	3.0	1.3	MD24-20
24	610	24	610	4.4	2.0	MD24-24

*Note: -16 parts have three panels, -20 parts have four panels, -24 parts have five panels.

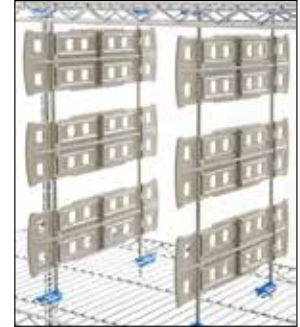

Shelf-to-Shelf Dividers

Three-Sided Double Snake Frames — {10.04}

Provide additional support or access to floor with these sturdy square snake frames. Plated finish.

Width/Length		Approx. Pkd. Wt.		Cat. No. Plated
(in.)	(mm)	(lbs.)	(kg)	
18x24	457x610	5	2.3	SF31N3C
18x30	457x760	6	2.7	SF32N3C
18x36	457x914	6 1/2	2.7	SF33N3C
18x42	457x1066	7	3.2	SF34N3C
18x48	457x1219	7 3/4	3.5	SF35N3C
18x60	457x1524	8	3.6	SF36N3C
18x72	457x1829	9	4.1	SF37N3C
21x24	530x610	5	2.3	SF41N3C
21x30	530x760	6	2.7	SF42N3C
21x36	530x914	6 1/2	2.7	SF43N3C
21x42	530x1066	7	3.2	SF44N3C
21x48	530x1219	8	3.6	SF45N3C
21x60	530x1524	8 1/2	3.8	SF46N3C
21x72	530x1829	10	4.5	SF47N3C
24x24	610x610	6	2.7	SF51N3C
24x30	610x760	7	3.2	SF52N3C
24x36	610x914	7 1/2	3.4	SF53N3C
24x42	610x1066	8	3.6	SF54N3C
24x48	610x1219	9	4.1	SF55N3C
24x60	610x1524	10	4.5	SF56N3C
24x72	610x1829	11	5.0	SF57N3C



Three-sided Double Snake Frame

21" Tall Divider

Chrome finish.
Fits 24" Deep Shelf
Cat. No. DD24C-21

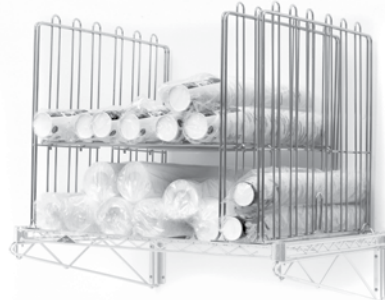

Horizontal Divider

Chrome finish.
Fits 21" Tall Divider
Available in 12" or 18" lengths
Cat. No. DDH24C-12
Cat. No. DDH24C-18

Rods and Tabs — {10.04}

Form side and back enclosures for a shelving unit. Can also serve as uniform dividers within unit by passing through shelves from top to bottom. Recommended spacing: every 6" (150mm) to 12" (305mm), depending upon shelf contents. Plated rods are shipped with 4 plated tabs per rod. Stainless steel rods come with 4 rust-proof tabs.

Min. Post Height	Rod Length		Approx. Pkd. Wt.		Cat. No. Plated	Cat. No. Stainless
(in.)	(in.)	(mm)	(lbs.)	(kg)		
54	52	1320	1	0.5	R52C	R52S
63	61	1549	1	0.5	R61C	R61S
74	72	1830	1 1/4	0.6	R72C	R72S
86	84	2135	1 1/2	0.7	R84C	R84S

Divide shelf space with rods to sort hard to manage items.



Additional Plated Tabs —
Bag of 12
Cat. No. 9084Z

Plated rod with plated tab.



Additional Rust-Proof Tabs —
Bag of 4
Cat. No. 9084P

Stainless Steel rod with rust-proof tab.



Decorator Shelf Inlays

Decorator Shelf Inlays — {10.06}

Hardboard mats prevent small items from falling through wire shelves. Fit between posts and level with top of shelf edge. Reversible, black and white. Packed individually.

Width/Length (in.) (mm)		Cat. No.
14x36	355x914	1436BWI
14x48	355x1219	1448BWI
18x24	457x610	1824BWI
18x36	457x914	1836BWI
18x48	457x1219	1848BWI
24x24	610x610	2424BWI
24x36	610x914	2436BWI
24x48	610x1219	2448BWI



Clear Shelf Inlays

Clear Shelf Inlays — {10.06}

Nearly invisible plastic mat retains open-wire look of shelves and allows light penetration. Sold in packages of 4.

Width/Length (in.) (mm)			Cat. No.	Width/Length (in.) (mm)			Cat. No.
14x36	355x914	1436CI-4		21x36	530x914	2136CI-4	
14x48	355x1219	1448CI-4		21x48	530x1219	2148CI-4	
14x60	355x1524	1460CI-4		21x60	530x1524	2160CI-4	
18x36	457x914	1836CI-4		24x36	610x914	2436CI-4	
18x48	457x1219	1848CI-4		24x48	610x1219	2448CI-4	
18x60	457x1524	1860CI-4		24x60	610x1524	2460CI-4	

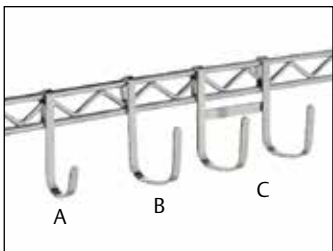

Snap-on Hooks

Snap-On Hooks — {10.05}

Multi-purpose hooks in three styles attach to hanger rails, mounting rails or shelves for instant access.

Description	Height (in.) (mm)	Cat. No. Chrome	Cat. No. Black
Style A — Small	3 ⁷ / ₁₆ 90	HK23C	HK23B
Style B — Large	3 ⁷ / ₁₆ 90	HK25C	HK25B
Style C — Double	3 ⁷ / ₁₆ 90	HK26C	

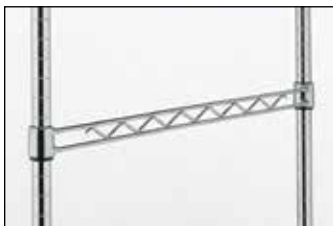

Hanger Rail

Hanger Rails — {10.05}

Convenient rail fits on posts along the width or length of the unit. Optional hooks can hang from rail at any point.

Length† (in.) (mm)	Approx. Pkd. Wt. (lbs.) (kg)	Cat. No. Chrome	Cat. No. Black	Cat. No. White	Cat. No. Smoked Glass	Cat. No. Designer Colors
14 355	1 .45	H114C	H114B	H114W	H114-DSG	H114-D
18 457	1 ¹ / ₄ .57	H118C	H118B	H118W	H118-DSG	H118-D
24 610	1 ¹ / ₂ .68	H124C	H124B	H124W	H124-DSG	H124-D
30 760	1 ¹ / ₂ .68	H130C	H130B	H130W	H130-DSG	H130-D
36 914	2 .90	H136C	H136B	H136W	H136-DSG	H136-D
48 1219	2 ¹ / ₂ 1.13	H148C	H148B	H148W	H148-DSG	H148-D

†14", 18" and 24" (355, 457 and 610mm) sizes fit shelf width (depth). 30", 36" and 48" (760, 914 and 1219mm) sizes fit shelf length.

Tray Slides — {10.04}

Free up shelves for more efficient use of space. Available in chrome and Metroseal 3 finish. 22³/₄" H. (578mm).

Width (in.)	Overall Depth (in.)	Slide Profile (in.)	On Center Slide Spacing (in.)		Fits Shelf Width (in.)		Approx. Weight/Pair (lbs.)		Cat. No. Chrome	Cat. No. Metroseal 3 with Microban®			
			(mm)	(mm)	(mm)	(mm)	(mm)	(mm)					
14 ⁵ / ₈	371	2 ¹ / ₄	56	1 ¹ / ₂	37	1 ¹ / ₂	37	18	457	9 ¹ / ₂	4.3	15SNC	15SNK3
20	508	2 ¹ / ₄	56	1 ¹ / ₂	37	1 ¹ / ₂	37	24	610	11	5.0	20SNC	20SNK3



Tray Slides

Super Erecta® Slide System — {10.04}

A super space-saving solution. Using Super Erecta® wire units 21" or 24" (530 and 610mm) wide, tote boxes and this innovative slide system, you have the flexibility to create a custom configuration that can be positioned quickly on new or existing units without the use of tools. Finish is nickel-chrome wire with clear protective coating.

Outside Slide Dimensions Height/Width/Length (in.)	(mm)	Fits Shelf Width (in.)	(mm)	Adaptable Boxes	Approx. Pkd. Wt. (lbs.)	(kg)	Cat. No.
10 ¹ / ₄ x20 ³ / ₈ x21 ⁵ / ₈	256x510x537	24	610	TB/MTB93030 TB/MTB93060 TB/MTB93080	4 ³ / ₄	2.1	SS2NC
10 ¹ / ₄ x14x17 ¹ / ₈	256x355x430	21	530	TB/MTB92035 TB/MTB92060 TB/MTB92080	3 ¹ / ₂	1.5	SS3NC
10 ¹ / ₄ x25 ¹ / ₈ x17 ¹ / ₈	256x630x430	21	530	TB/MTB93030* TB/MTB93060* TB/MTB93080*	4	1.8	SS4NC

*Fits SS4NC with box turned sideways.



Super Erecta Slide System in place on shelf (Tote box sold separately)

Adjustable Undershelf Slides — {10.04}

These slides can be spaced to fit any width container or tote box.

Item	Approx. Pkd. Wt. (lbs.)	(kg)	Cat. No. (pair)
For 18" (457mm) wide shelf	1	0.4	US18NA
*For 21" (530mm) wide shelf	1	0.4	US21NA
For 24" (610mm) wide shelf	1	0.4	US24NA

*Not adaptable to 24" (610mm) long shelf.



Adjustable Undershelf Slide

File Basket — {10.05}

The convenient place to keep files and papers.

- Measures 2⁵/₈" W. x 12³/₄" L. x 8³/₄" H. (67mm W. x 324mm L. x 222mm H.).
- Large enough to hold standard-size file folders.
- Attaches easily.

Width/Length (in.)	(mm)	Height (in.)	(mm)	Approx. Pkd. Wt. (lbs.)	(kg)	Cat. No.
2 ⁵ / ₈ x12 ³ / ₄	63x330	8 ³ / ₄	228	2.1	1.0	PH1239C



File Basket

Garment Hanger Tube with Brackets — {10.05}

Hanger tubes attach easily under Super Erecta shelves for hanging garments. Available in 18", 21" and 24" (457, 530 and 610mm) widths and in same length as shelves.

Tube Length (in.)	(mm)	Approx. Pkd. Wt. (lbs.)	(kg)	Shelf Width 18" (457mm)	Shelf Width 21" (530mm)	Shelf Width 24" (610mm)
24	610	2 ¹ / ₂	1.1	AT2418NC	AT2421NC	AT2424NC
30	760	2 ¹ / ₂	1.1	AT3018NC	AT3021NC	AT3024NC
36	914	3	1.4	AT3618NC	AT3621NC	AT3624NC
42	1066	3 ¹ / ₂	1.6	AT4218NC	AT4221NC	AT4224NC
48	1219	3 ¹ / ₂	1.6	AT4818NC	AT4821NC	AT4824NC
60	1524	4	1.8	AT6018NC	AT6021NC	AT6024NC
72	1828	4 ¹ / ₂	2.0	AT7218NC	AT7221NC	AT7224NC

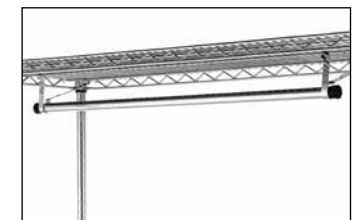

Garment Hanger Tube with Brackets

Indicates antimicrobial product.



Large Display/Storage Basket

Storage Baskets — {10.05}

Generous-sized baskets attach in seconds to hanger rail or shelves.

Width/Length/Depth (in.)		Width/Length/Depth (mm)		Approx. Pkd. Wt. (lbs.) (kg)		Cat. No. Plated	Cat. No. Black	Cat. No. White	Cat. No. Smoked Glass
13 ³ / ₈	5x7	345	127x180	8 ¹ / ₂	4	H209C	H209B	H209W	H209-DSG
17 ³ / ₈	7 ¹ / ₂ x5	440	190x127	7	3	H210C	H210B	H210W	H210-DSG
17 ³ / ₈	7 ¹ / ₂ x10	440	190x255	11	5	H212C	H212B	H212W	H212-DSG



Swing Hanger

Swing Hanger — {10.05}

Attaches to post to provide convenient storage for hanging items. Red epoxy finish.

Arm Length (in.)	Arm Length (mm)	Weight Capacity (lbs.) (kg)		Cat. No.
6 ¹ / ₄	160	20	9	H110R



Extension Display Hanger

Extension Display Hanger — {10.06}

Snaps on Super Erecta Shelf hanger rails and shelf frames. Accepts standard carded merchandise.

Length (in.)		Length (mm)		Approx. Pkd. Wt. (lbs.) (kg)		Finish/Color*	Cat. No.
6	152	.25	.1	Chrome	HHK6C		
6	152	.25	.1	Black	HHK6B		
8	203	.25	.1	Chrome	HHK8C		
8	203	.25	.1	Black	HHK8B		

*White, smoked glass and designer colors also available. Allow 4-6 week lead time.

Color Shelf Marker — {10.05}

Color code for effective organization. Snaps securely to the front edge of Super Erecta and Super Adjustable Super Erecta Wire Shelving.

Shelf Marker Size (in.)		Color	Cat. No.	Shelf Marker Size (mm)		Color	Cat. No.
6x1 ¹ / ₄	152x32	Blue	CSM6-B	6x1 ¹ / ₄	152x32	White	CSM6-W
6x1 ¹ / ₄	152x32	Green	CSM6-G	6x1 ¹ / ₄	152x32	Yellow	CSM6-Y
6x1 ¹ / ₄	152x32	Red	CSM6-R	6x1 ¹ / ₄	152x32	Gray	CSM6-GR
6x1 ¹ / ₄	152x32	Tan	CSM6-T				



CSM6-B



CSM6-G



CSM6-R



CSM6-T

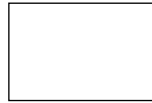

CSM6-W

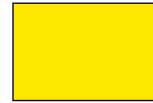

CSM6-Y



CSM6-GR



Color Shelf Markers

Label Holders

It's easy to identify shelf contents with these snap-on plastic holders, available in four styles and a variety of sizes. Labels not included.

1¹/₄" (32mm) Label Holders — {10.05}

Gray. Holds most commercial labels. Available in a variety of lengths.

Label Size (in.)		Fits Shelf Length (in.)		Cat. No.
3x1 ¹ / ₄	75x32	All		9990P
13x1 ¹ / ₄	330x32	18	457	9990P1
19x1 ¹ / ₄	480x32	24	610	9990P2
25x1 ¹ / ₄	635x32	30	760	9990P30
31x1 ¹ / ₄	725x32	36	914	9990P3
43x1 ¹ / ₄	1090x32	48	1219	9990P4
55x1 ¹ / ₄	1395x32	60	1520	9990P5

For Cantilever Shelves, use 3" (75mm) label holder only.



1¹/₄" (32mm) Label Holder

Clear Label Holders — {10.05}

Clear plastic allows decorator colors to show through. Holds most commercial 1¹/₄" (32mm) labels.

Label Size (in.)		Fits Shelf Length (in.)		Cat. No.
3x1 ¹ / ₄	75x32	All		9990CL
13x1 ¹ / ₄	330x32	18	457	9990CL1
19x1 ¹ / ₄	480x32	24	610	9990CL2
25x1 ¹ / ₄	635x32	30	760	9990CL30
31x1 ¹ / ₄	725x32	36	914	9990CL3
43x1 ¹ / ₄	1090x32	48	1219	9990CL4
55x1 ¹ / ₄	1395x32	60	1520	9990CL5

For Cantilever Shelves, use 3" (75mm) label holder only.



Clear Label Holder

Slanted Label Holders — {10.05}

Gray solid plastic holder puts 1¹/₄" (32mm) labels on slant for easier viewing.

Label Size (in.)		Fits Shelf Length (in.)		Cat. No.
3x1 ¹ / ₄	75x32	All		9990SL
13x1 ¹ / ₄	330x32	18	457	9990SL1
19x1 ¹ / ₄	480x32	24	610	9990SL2
25x1 ¹ / ₄	635x32	30	760	9990SL30
31x1 ¹ / ₄	725x32	36	914	9990SL3
43x1 ¹ / ₄	1090x32	48	1219	9990SL4
55x1 ¹ / ₄	1395x32	60	1520	9990SL5

For Cantilever Shelves, use 3" (75mm) label holder only.



Slanted Label Holder



21X48X54UCMB
(shown in Mariner Blue)

Shelving and Cart Covers — {11.80}

- Help protect contents from dust and other air-borne contaminants.
- This allows units to be loaded and stored for longer periods of time before being transported. Covers also deter pilferage.
- Reinforced Corners: Help prevent tears and add greatly to durability of covers.
- Closure: Available in hook/loop or heavy-duty nylon zipper

Uncoated — machine washable:

- White: Knitted polyester, 4 oz. per square yard
- Mariner Blue: Woven polyester, 3.2 oz. per square yard.

Coated — waterproof, perfect for indoor/outdoor use:

- White or Mariner Blue — vinyl-coated nylon, 10 oz. per square yard
- Specially treated to resist bacteria, odor, mildew and flames

Catalog Numbers shown are for white cover. Add “MB” suffix to order Mariner Blue (i.e. 21X48X54UCMB)

Length/Height (in.)	Length/Height (mm)	White Nylon Uncoated		White Vinyl Coated	
		Zippered Closure Cat. No.	Velcro Closure Cat. No.	Zippered Closure Cat. No.	Velcro Closure Cat. No.
FOR SHELF TRUCKS & CARTS 18" (457mm) DEEP					
36x54	914x1370	18X36X54UC	18X36X54VUC	18X36X54C	18X36X54VC
36x62	914x1550	18X36X62UC	18X36X62VUC	18X36X62C	18X36X62VC
48x54	1219x1370	18X48X54UC	18X48X54VUC	18X48X54C	18X48X54VC
48x62	1219x1550	18X48X62UC	18X48X62VUC	18X48X62C	18X48X62VC
60x54	1524x1370	18X60X54UC	18X60X54VUC	18X60X54C	18X60X54VC
60x62	1524x1550	18X60X62UC	18X60X62VUC	18X60X62C	18X60X62VC
FOR SHELF TRUCKS & CARTS 21" (530mm) DEEP					
48x54	1219x1370		21X48X54VUC	21X48X54C	21X48X54VC
48x62	1219x1550		21X48X62VUC	21X48X62C	21X48X62VC
48x74	1219x1850		21X48X74VUC	21X48X74C	21X48X74VC
60x54	1524x1370		21X60X54VUC	21X60X54C	21X60X54VC
60x62	1524x1550		21X60X62VUC	21X60X62C	21X60X62VC
60x74	1524x1850		21X60X74VUC	21X60X74C	21X60X74VC
FOR SHELF TRUCKS & CARTS 24" (610mm) DEEP					
36x54	914x1370		24X36X54VUC	24X36X54C	24X36X54VC
36x62	914x1550		24X36X62VUC	24X36X62C	24X36X62VC
36x74	914x1850		24X36X74VUC	24X36X74C	24X36X74VC
48x54	1219x1370		24X48X54VUC	24X48X54C	24X48X54VC
48x62	1219x1550		24X48X62VUC	24X48X62C	24X48X62VC
48x74	1219x1850		24X48X74VUC	24X48X74C	24X48X74VC
60x54	1524x1370		24X60X54VUC	24X60X54C	24X60X54VC
60x62	1524x1550		24X60X62VUC	24X60X62C	24X60X62VC
60x74	1524x1850		24X60X74VUC	24X60X74C	24X60X74VC
72x54	1825x1370		24X72X54VUC	24X72X54C	24X72X54VC
72x62	1825x1550		24X72X62VUC	24X72X62C	24X72X62VC
72x74	1825x1850		24X72X74VUC	24X72X74C	24X72X74VC

*Cart covers are non-returnable.
Note: 86" (2185mm) high covers, in 24" (610mm) depth, available by special order.



Clear Vinyl
Cart Cover

Clear Vinyl Cart Covers

- Allows visual access while protecting shelf contents from dust and other airborne contaminants.
- Vinyl construction with Velcro closures.
- Available for 18" x 36" (457 x 914mm) shelving.

Length/Height (in.)	Length/Height (mm)	Cat. No.
36x32	914x889	GWCVC41
36x52	914x1320	GWCVC62

☑ Indicates antimicrobial product.

Keyboard Tray — {10.06}

Attaches to all Metro wire shelves, 36" (914mm) length or longer. Mouse Tray adapts to left or right of Keyboard Tray. Flip-top compartment provides convenient storage. Constructed of durable high-impact polystyrene. Assembles easily.

- Hardware included for attachment to Metro wire shelves; template provided for attachment to solid desk surfaces.
- Keyboard Tray Dimensions: 22" L. (559mm) x 15 1/2" W. (394mm).
- Dimension with Mouse Tray fully extended: 29 1/2" L. (749mm) x 15 1/2" W. (394mm).

Cat. No. CKS1522BL



Keyboard Tray

Wire Management Clip — {10.06}

Keeps wires and cables neatly organized both horizontally and vertically. Easily snaps over the edge of any Super Erecta wire or qwikSLOT shelf. Black epoxy finish.

Width (in.) (mm)		Length (in.) (mm)		Approx. Pkd. Wt. (lbs.) (kg)		Cat. No.
2	51	2	51	.5	.25	CWM



Wire Management Clip

Power Strip — {10.06}

- Mounts quickly and easily to either a Super Erecta or qwikSLOT post.
- Includes a 15 foot (4572mm) long cord.
- Mounting brackets and hardware included.
- UL/CSA approved.
- 15 Amp Circuit Breaker.
- Illuminated Power Switch. 15A/125VAC.60Hz/1875 W.
- Gray/blue finish.
- 14/3 SJT Molded Power Supply Cord.

Width (in.) (mm)		Length (in.) (mm)		Approx. Pkd. Wt. (lbs.) (kg)		Cat. No.
1 1/2	38	48	1219	6	2.72	CPS48



Power Strip

Surface Mount Swing Arm for Flat Monitor — {10.06}

- Range: Vertical, 15.9" (404mm); Horizontal 24 1/4" (613mm)
- Vertical Rotation: 360 degrees at three joints
- Monitor tilt: 200 degrees
- Monitor pivot: landscape to portrait
- Compatibility: VESA® 75mm and 100mm
- Cable management: Cables are concealed in arm
- Maximum weight load: 27.5 lbs. (12.5kg)



Cat. No. LTFMA

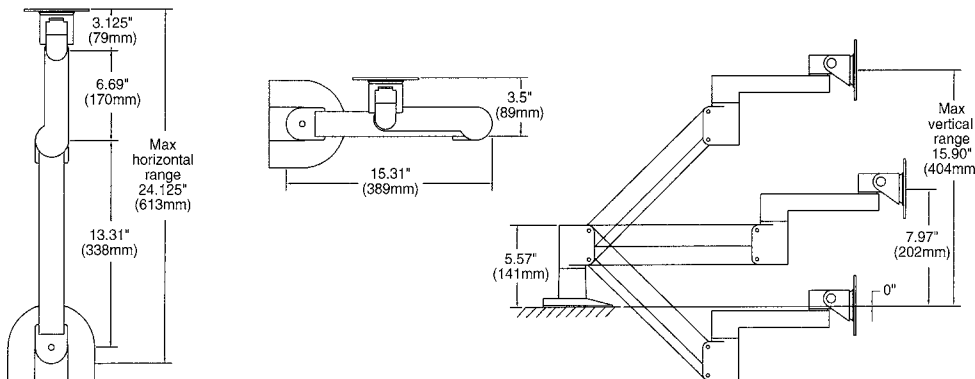

KITCHEN STORAGE

MAKEOVER

SPONSORED
EXCLUSIVELY BY

METRO[®]

2018

**Fort William
Henry Hotel**

BEFORE

Prep areas use limited space poorly. Walls and storage above are not optimized for productivity.

AFTER

SmartWall[®], SmartLever[™] & PrepMate[™] create an extremely functional space for wait staff and prep staff alike.

“Truly a vast improvement by identifying unused wall space.”

BEFORE



Metro's SmartWall[®] creates the ideal set-up for a kitchen prep sink. Keeping all the items easily at hand and stored safely!

AFTER



AFTER



BEFORE



Maximizing space begins with understanding what you will need to store. Shelf layout, shelf levels, rolling racks and pan racks placement should all be factored in!

2019

JCC of Columbus

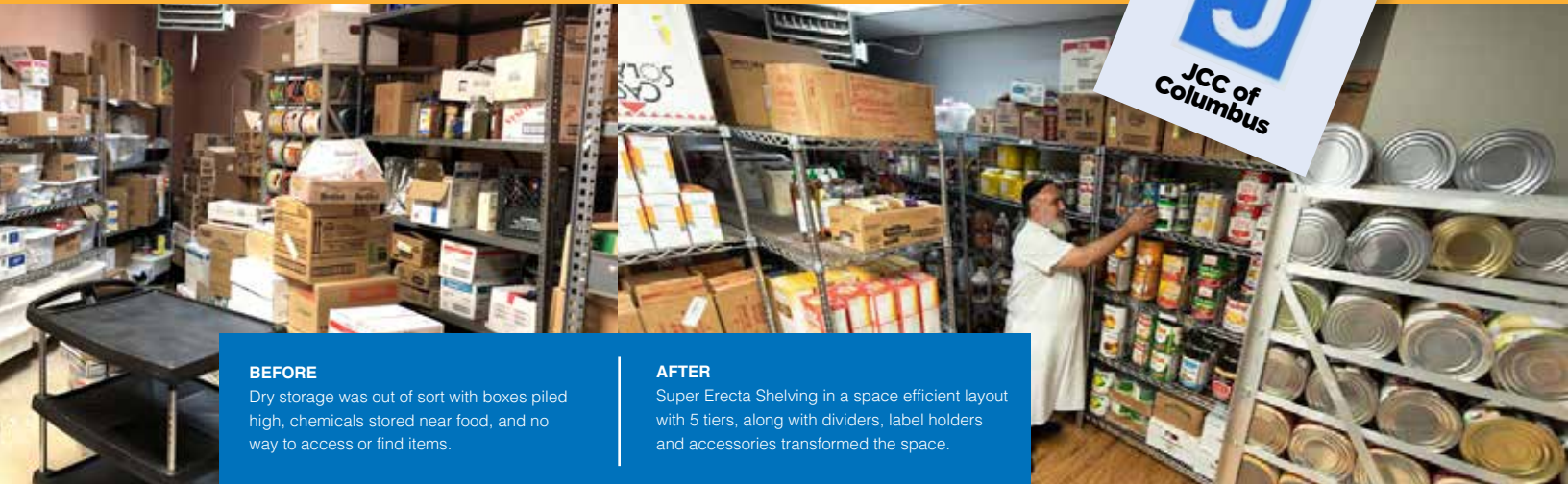

BEFORE

Dry storage was out of sort with boxes piled high, chemicals stored near food, and no way to access or find items.

AFTER

Super Erecta Shelving in a space efficient layout with 5 tiers, along with dividers, label holders and accessories transformed the space.

“Wow... this SmartWall® is really... smart!”



BEFORE

Metro's SmartWall® creates the ideal set-up for the meat prep in this kosher kitchen. Keeping items labeled and right at hand!

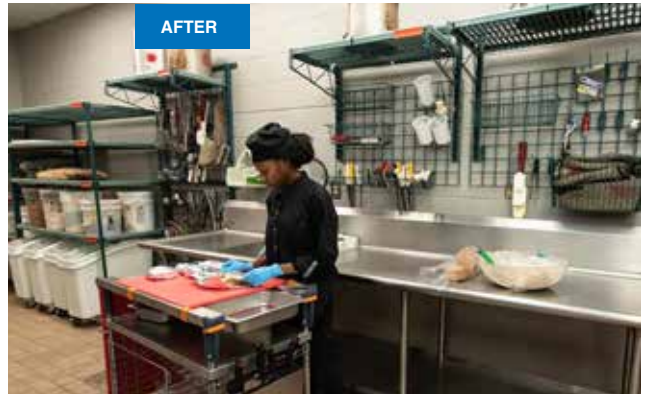

AFTER

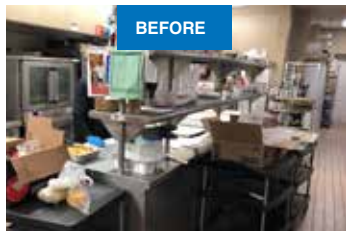

BEFORE

The large stainless fab system was huge and not functional at all. Actually it had little usable space. Now, its a prep dream... open & functional.

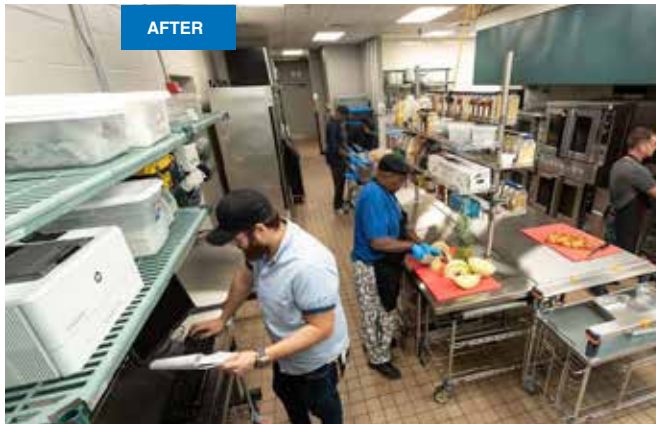

AFTER

“This is the crowning achievement... I love this prep space.”



Super Erecta qwikSLOT™ shelving unit in black epoxy

qwikSLOT® Display Shelving System

Set, Reset in a Flash.

Metro qwikSLOT shelves offer the quality of Super Erecta with the convenience of easily adjustable and removable shelves.

- Unique support system snaps into the posts, allowing instant shelf adjustment.
- Each unit requires a standard Super Erecta shelf at the top and bottom. (see page 42)

qwikSLOT® Shelves — {10.11}

Width/Length (in.)	Approx. Pkd. Wt. (lbs.)	Cat. No. Super Erecta Brite	Cat. No. Chrome	Cat. No. Black	Cat. No. White	Cat. No. Smoked Glass
14x36	7.25	1436QBR	1436QC	1436QBL	1436QW	1436Q-DSG
14x48	9.75	1448QBR	1448QC	1448QBL	1448QW	1448Q-DSG
18x36	8.5	1836QBR	1836QC	1836QBL	1836QW	1836Q-DSG
18x48	11.25	1848QBR	1848QC	1848QBL	1848QW	1848Q-DSG
18x60	17.0	1860QBR	—	—	—	—
21x36	10.75	2136QBR	2136QC	2136QBL	2136QW	2136Q-DSG
21x48	13.25	2148QBR	2148QC	2148QBL	2148QW	2148Q-DSG
21x60	18.0	2160QBR	—	—	—	—
24x36	12.25	2436QBR	2436QC	2436QBL	2436QW	2436Q-DSG
24x48	15.25	2448QBR	2448QC	2448QBL	2448QW	2448Q-DSG
24x60	21.00	2460QBR	—	—	—	—

Note: A typical unit will incorporate 4 qwikSLOT posts, at least 2 standard Super Erecta shelves (one at the top and bottom of unit) and as many qwikSLOT shelves as desired between the top and bottom shelf.

Note: A qwikSLOT shelf is rated at 300 lbs. (135kg) per shelf. A typical qwikSLOT unit is rated at 800 lbs. (375kg) capacity per unit. For higher unit capacities, an intermediate standard Super Erecta shelf must be installed approximately at mid-height on the unit.

Note: Mobile Applications: All mobile applications require an intermediate standard Super Erecta shelf installed approximately at mid-height on the unit.



qwikSLOT post with shelf clip

qwikSLOT® Posts — {10.11}

Clips snap into slots along the height of the post for shelf adjustment at 1" (25mm) intervals. Use for qwikSLOT shelving only.

Stationary

Height† (in.)	(mm)	Approx. Pkd. Wt. (lbs.)	(kg)	Cat. No. Super Erecta Brite	Cat. No. Black	Cat. No. White	Cat. No. Smoked Glass
34 1/2	875	2	0.9	33PQ	33PQBL	33PQW	33PQ-DSG
54 9/16	1385	3	1.4	54PQ	54PQBL	54PQW	54PQ-DSG
63 9/16	1590	3 1/2	1.6	63PQ	63PQBL	63PQW	63PQ-DSG
74 5/8	1895	4	1.8	74PQ	74PQBL	74PQW	74PQ-DSG
86 5/8	2200	5	2.3	86PQ	86PQBL	86PQW	86PQ-DSG

†Height includes leveling bolt and cap.

Mobile

Height† (in.)	(mm)	Approx. Pkd. Wt. (lbs.)	(kg)	Cat. No. Super Erecta Brite	Cat. No. Black	Cat. No. White	Cat. No. Smoked Glass
33 7/8	861	2	0.9	33UPQ	33UPQBL	33UPQW	33UPQ-DSG
54	1370	3	1.4	54UPQ	54UPQBL	54UPQW	54UPQ-DSG
62	1575	3 1/2	1.6	63UPQ	63UPQBL	63UPQW	63UPQ-DSG
74	1880	4	1.8	74UPQ	74UPQBL	74UPQW	74UPQ-DSG
86	2185	5	2.3	86UPQ	86UPQBL	86UPQW	86UPQ-DSG

These posts come without leveling bolt assembly to accommodate stem casters.



qwikSLOT Locking Clip

Recommended for mobile applications. Must be used with 9985QS shelf clips. (Package of 4) Cat. No. **9985QSL**



Replacement qwikSLOT Shelf Clips

(Package of 4) Cat. No. **9985QS**

SET UP YOUR METRO STORE-WITHIN-A-STORE

1. Assemble your new Metro Display Shelving System (no tools required).
2. Remove upper shelves of your existing gondola unit. Do not remove the base shelf or kick panel.
3. Place your new Metro display shelving unit onto the gondola base shelf and slide into place.

Metro Tip: Order optional triangular foot plates to replace leveling bolts. Foot plates distribute heavy weight more evenly. (See page 47).



Great for Retail Display.

Research shows sales and profits increase more than **43%**.

Data was collected from ten stores operated by three food retailers in the United States. The research covered 15 product categories and thousands of items. The research was conducted by Willard Bishop Consulting Ltd. and involved two areas of research:

- In-store merchandising tests and point-of-sale data analysis to quantify sales/profits and total category impact.
- Consumer focus groups to qualify consumer reaction.

Visit www.metro.com/grocerysolutions and click on the link to Store-Within-A-Store Research.

Sales and profits for specialty items increased more than 43%. Total category performance demonstrated a 12+% increase in sales and 14+% increase in profits.

Uniquely profitable.

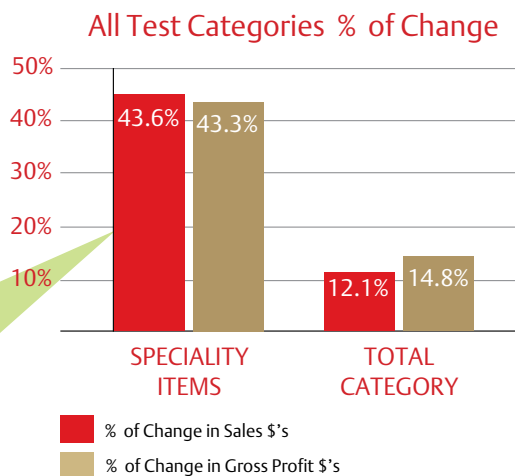

qwikSLOT® Display Shelving makes creating your Store-Within-A-Store simple and easy.





qwikSLOT Drop Mat Shelving

qwikSLOT® Drop Mat® and Drop Mat® Super Erecta® Display Shelving — {10.11}

- Built-in shelf ledge, approximately 1" (25mm) high, provides security, preventing contents from falling off shelf.
- Each shelf holds up to 250 pounds (113kg). Available in Super Erecta and qwikSLOT styles.

qwikSLOT® Drop Mat Shelves — {10.20}

Drop Mat shelving can increase storage capacity by as much as 30%. Each shelf holds up to 250 pounds (113kg). qwikSLOT style promotes ease of adjustment and removal. Each qwikSLOT unit requires the use of a Super Erecta or Drop Mat Super Erecta shelf at top and bottom. Use with qwikSLOT posts.

Width/Length (in.)	Approx. Pkd. Wt. (lbs.)	Cat. No. Super Erecta Brite	Cat. No. Chrome	Cat. No. Black	Cat. No. White	Cat. No. Smoked Glass
14x36	7.25	HDM1436QBR	HDM1436QC	HDM1436QBL	HDM1436QW	HDM1436Q-DSG
14x48	9.75	HDM1448QBR	HDM1448QC	HDM1448QBL	HDM1448QW	HDM1448Q-DSG
18x36	8.5	HDM1836QBR	HDM1836QC	HDM1836QBL	HDM1836QW	HDM1836Q-DSG
18x48	11.25	HDM1848QBR	HDM1848QC	HDM1848QBL	HDM1848QW	HDM1848Q-DSG
21x36	10.75	HDM2136QBR	HDM2136QC	HDM2136QBL	HDM2136QW	HDM2136Q-DSG
21x48	13.25	HDM2148QBR	HDM2148QC	HDM2148QBL	HDM2148QW	HDM2148Q-DSG
24x36	12.25	HDM2436QBR	HDM2436QC	HDM2436QBL	HDM2436QW	HDM2436Q-DSG
24x48	15.25	HDM2448QBR	HDM2448QC	HDM2448QBL	HDM2448QW	HDM2448Q-DSG

Drop Mat® Super Erecta® Display Shelving — Use with qwikSLOT or Super Erecta posts

Width/Length (in./mm)		Approx. Pkd. Wt. (lbs./kg)		Cat. No. Super Erecta Brite	Cat. No. Chrome	Cat. No. Black	Cat. No. White	Cat. No. Smoked Glass
14x36	355x914	7.25	3.2	HDM1436BR	HDM1436NC	HDM1436BL	HDM1436W	HDM1436-DSG
14x48	355x1219	9.75	4.3	HDM1448BR	HDM1448NC	HDM1448BL	HDM1448W	HDM1448-DSG
18x36	457x914	8.5	3.8	HDM1836BR	HDM1836NC	HDM1836BL	HDM1836W	HDM1836-DSG
18x48	457x1219	11.25	5.0	HDM1848BR	HDM1848NC	HDM1848BL	HDM1848W	HDM1848-DSG
21x36	530x914	10.75	4.8	HDM2136BR	HDM2136NC	HDM2136BL	HDM2136W	HDM2136-DSG
21x48	530x1219	13.25	5.9	HDM2148BR	HDM2148NC	HDM2148BL	HDM2148W	HDM2148-DSG
24x24	610x614	8.5	3.8	HDM2424BR	HDM2424NC	HDM2424BL	HDM2424W	HDM2424-DSG
24x36	610x914	12.25	5.5	HDM2436BR	HDM2436NC	HDM2436BL	HDM2436W	HDM2436-DSG
24x48	610x1219	15.25	6.8	HDM2448BR	HDM2448NC	HDM2448BL	HDM2448W	HDM2448-DSG

qwikSLOT® Posts — {10.11}

Clips snap into slots along the height of the post for shelf adjustment at 1" (25mm) intervals. Use for qwikSLOT shelving only.

Height† (in./mm)	Approx. Pkd. Wt. (lbs./kg)	STATIONARY				MOBILE					
		Cat. No. Plated	Cat. No. Black	Cat. No. White	Cat. No. Smoked Glass	Cat. No. Plated	Cat. No. Black	Cat. No. White	Cat. No. Smoked Glass		
34 ¹ / ₂	875	2	0.9	33PQ	33PQBL	33PQW	33PQ-DSG	33UPQ	33UPQBL	33UPQW	33UPQ-DSG
54 ⁹ / ₁₆	1385	3	1.4	54PQ	54PQBL	54PQW	54PQ-DSG	54UPQ	54UPQBL	54UPQW	54UPQ-DSG
63 ⁹ / ₁₆	1590	3 ¹ / ₂	1.6	63PQ	63PQBL	63PQW	63PQ-DSG	63UPQ	63UPQBL	63UPQW	63UPQ-DSG
74 ⁵ / ₈	1895	4	1.8	74PQ	74PQBL	74PQW	74PQ-DSG	74UPQ	74UPQBL	74UPQW	74UPQ-DSG
86 ⁵ / ₈	2200	5	2.3	86PQ	86PQBL	86PQW	86PQ-DSG	86UPQ	86UPQBL	86UPQW	86UPQ-DSG

†Height includes leveling bolt and cap.

Super Erecta SiteSelect® Posts — {10.01a}

Height* (in./mm)	Approx. Pkd. Wt. (lbs./kg)	STATIONARY		MOBILE			
		Cat. No. Chrome	Cat. No. Black	Cat. No. Chrome	Cat. No. Black		
7 ¹ / ₂	191	1/2	0.3	7P	7PBL	—	—
14 ¹ / ₂	370	1	0.5	13P	13PBL	—	—
27 ¹ / ₂	699	1 ³ / ₄	0.75	27P	27PBL	27UP	27UPBL
34 ¹ / ₂	875	2	0.9	33P	33PBL	33UP	33UPBL
54 ⁹ / ₁₆	1385	3	1.4	54P	54PBL	54UP	54UPBL
62 ⁹ / ₁₆	1590	3 ¹ / ₂	1.6	63P	63PBL	63UP	63UPBL
74 ⁵ / ₈	1895	4	1.8	74P	74PBL	74UP	74UPBL
86 ⁵ / ₈	2200	5	2.3	86P	86PBL	86UP	86UPBL
96 ⁵ / ₈	2454	5 ¹ / ₂	2.5	***96P	—	—	—

Mobile posts come without leveling bolt assembly to accommodate stem casters.

* Height includes leveling bolt and cap.

*** 96P should not be used on units less than 24" (610mm) deep. Consult Metro Engineering for alternate recommendations.

† Note: Special length posts are available, priced at next higher length plus a cutting charge. Post lengths to be specified as cut to a round number, ie: 74P cut to 69" (1753mm) . . . This will result in an overall post height with adjustment of 69⁵/₈" (1762mm) to 69⁷/₈" (1775mm).

Snap-On Dividers for Drop Mat Shelves — {10.04}

Organize your shelves with these 8" (203mm) high, easy to snap-in-place dividers.

Fits Shelf Width (in.) (mm)	Approx. Pkd. Wt. (lbs.) (kg)	Cat. No. Plated	Cat. No. Black	Cat. No. White	Cat. No. Smoked Glass	Cat. No. Designer Colors*
18 457	2.5 1.1	HD18C	HD18B	HD18W	HD18-DSG	HD18-D
24 614	3.5 1.6	HD24C	HD24B	HD24W	HD24-DSG	HD24-D

*Refer to page 131 for information about Designer Colors.



Snap-On Divider

Get Maximum Retail Density.

Drop Mat® Display Shelving.

Increase your shelving holding power by up to **30%**.



Drop Mat yields space saving results. The space gain is undeniable.



What's the secret to increasing holding power?

- The secret to Metro's space-saving advantage is Drop Mat's "thin shelf" design (1/4" versus 1 1/2"). Drop Mat eliminates the need for space robbing under-shelf supports and bulky shelf brackets, reclaiming 20% of your merchandising space.
- Back-to-back, Drop Mat saves yet more space. Reclaim up to 10% additional space by eliminating traditional gondola's 4" wide center support structure.

Two Quick Two Smart Two Bin



Metro® Two-Bin™ Solutions take efficiency to the next level.

This two-bin solution offers better visibility to stored items, easier replenishment, and maximized storage space. Metro Two-Bin solutions provide a bin offering to accommodate varying supply sizes, a broad shelf offering to maximize storage and provide better visibility to stored items, and color coded markers to help identify supplies by type or application.

- Customizable shelf spacing and ability to use a variety of **Super Erecta®** shelves and posts maximize storage capacity. Available in stationary or mobile.

> Wide range of bin offerings to accommodate supply sizes

- **qwikSLOT®** shelves can be slanted for easy access to supplies while it's unique design allows for quick repositioning.

> Color coded markers and clear bins aid in swift visual identification



Metro® qwikSLOT® Shelving System
Shown with Solid Bottom Shelf

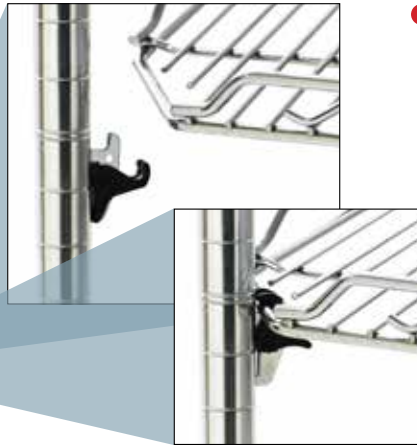

Safely holds up to
800 lbs.

800lbs. (375kg) per unit
300 lbs. (135 kg) per shelf
(qwikSLOT)

- Metro qwikSLOT® shelves offer the quality of Super Erecta® with the convenience of easily adjustable and removable shelves.
- Unique support system snaps into posts, allowing instant shelf adjustment without disturbing the shelves below or above.
- Versatile design allows shelves to be installed flat or at a unique angle for ultimate space and display efficiency. All shelves adjust in 1" increments.

qwikSLOT® Shelves — {10.11}

Width/Length	SOLID Galvanized Cat. No.	qwikSLOT Brite Cat. No.	3-Sided Frame Super Erecta Chrome Cat. No.	STANDARD Super Erecta Chrome Cat. No.
18x36	1836FG	1836QBR	SF33N3C	1836NC
18x48	1848FG	1848QBR	SF35N3C	1848NC
18x60	1860FG	1860QBR	SF36N3C	1860NC
24x36	2436FG	2436QBR	SF53N3C	2436NC
24x48	2448FG	2448QBR	SF55N3C	2448NC
24x60	2460FG	2460QBR	SF56N3C	2460NC
Pkg of 4 Locking clips		9985QSL	-	-

Note: A typical unit will incorporate 4 qwikSLOT posts, at least 2 Super Erecta shelves (one at the top and bottom of unit) and as many qwikSLOT shelves as desired between the top and bottom shelf. A three sided frame is recommended for increased rigidity.

Note: A qwikSLOT shelf is rated at 300 lbs. (135kg) per shelf. A typical qwikSLOT unit is rated at 800 lbs. (375kg) capacity per unit. For higher unit capacities, an intermediate standard Super Erecta shelf must be installed approximately at mid-height on the unit.

Note: Mobile Applications: All mobile applications require an intermediate standard Super Erecta shelf installed approximately at mid-height on the unit.



qwikSLOT Locking Clip

For mobile applications. To be used with qwikSLOT shelf clips. (Package of 4) Cat. No. 9985QSL



Casters types available for all mobile applications.

qwikSLOT® Posts — {10.11}

Height		qwikSLOT Stationary Posts Brite Cat. No.	Height		qwikSLOT Mobile Posts Brite Cat. No.	Wheel Diameter		Type	Resilient Tread Cat. No.	Polyurethane Tread Cat. No.
(in)	(mm)		(in)	(mm)		(in)	(mm)			
34 ¹ / ₂	875	33PQ	33 ⁷ / ₈	861	33UPQ	5	32	Swivel	5M	5MP
54 ⁹ / ₁₆	1385	54PQ	54	1370	54UPQ	5	132	Swivel/Brake	5MB	5MPB
63 ⁹ / ₁₆	1590	63PQ	62	1575	63UPQ					
74 ⁵ / ₈	1895	74PQ	74	1880	74UPQ					
86 ⁵ / ₈	2200	86PQ	86	2185	86UPQ					

Metro Bins — {10.08}

Convenient way to organize and identify small items.

Shelf Bins — Nesting

These bins are sized to work on the two most popular shelf widths 18" (457mm) and 24" (610mm) for efficient handling and exchange.



MB30164CLN



MB30184CLN



MB30174CLN

Part No.	Outside Dimension (in.)		Outside Dimension (mm)		Bin Carton Quantity	Color	Width Dividers**	Divider Carton Quantity
	Length / Width / Height	Length / Width / Height	Length / Width / Height	Length / Width / Height				
MB30110CLN	11.6 x 2.75 x 4	295 x 70 x 102	24	Clear	N/A	N/A		
MB30120CLN	11.6 x 4.12 x 4	295 x 105 x 102	24	Clear	MB40120 (3)	24		
MB30130CLN	11.6 x 6.6 x 4	295 x 168 x 102	12	Clear	MB40130 (3)	24		
MB30150CLN	11.6 x 8.37 x 4	295 x 213 x 102	12	Clear	-	-		
MB30170CLN	11.6 x 11.12 x 4	295 x 282 x 102	12	Clear	MB40170 (3)	24		
MB30128CLN	17.8 x 4.12 x 4	454 x 105 x 102	12	Clear	MB40120 (3)	24		
MB30138CLN	17.8 x 6.6 x 4	454 x 168 x 102	12	Clear	MB40130 (3)	24		
MB30124CLN	23.6 x 4.12 x 4	600 x 105 x 102	12	Clear	MB40120 (3)	24		
MB30164CLN	23.6 x 6.6 x 4	600 x 168 x 102	6	Clear	MB40130 (3)	24		
MB30174CLN	23.6 x 10.6 x 4	600 x 270 x 102	2	Clear	MB40170 (3)	24		

Supply Bins — Stacking or Hanging

Stackable design maximizes vertical storage efficiency. Reinforced design adds strength and prevents spreading. Lip on rear of bin allows bin to hang on the wall panel.



MB30239CLSH



MB30235CLSH



MB30255CLSH

Part No.	Outside Dimension (in.)		Outside Dimension (mm)		Bin Carton Quantity	Color	Length Dividers**	Divider Carton Quantity
	Length / Width / Height	Length / Width / Height	Length / Width / Height	Length / Width / Height				
MB30220CLSH	7.3 x 4.12 x 3	187 x 105 x 76	24	Clear	-	-		
MB30237CLSH	9.25 x 6 x 5	235 x 152 x 127	12	Clear	N/A	N/A		
MB30224CLSH	10.8 x 4.12 x 4	276 x 105 x 102	12	Clear	-	-		
MB30230CLSH	10.8 x 5.5 x 5	276 x 140 x 127	12	Clear	MB40230 (1)	6		
MB30235CLSH	10.8 x 11 x 5	276 x 279 x 127	6	Clear	MB40230 (2)	6		
MB30239CLSH	10.8 x 8.25 x 7	276 x 210 x 178	6	Clear	-	-		
MB30255CLSH	10.8 x 16.5 x 5	276 x 419 x 127	6	Clear	MB40230 (2)	6		
MB30234CLSH	14.75 x 5.5 x 5	375 x 140 x 127	12	Clear	-	-		
MB30240CLSH	14.75 x 8.25 x 7	375 x 210 x 178	12	Clear	MB40245 (1)	6		
MB30250CLSH	14.75 x 16.5 x 7	375 x 419 x 178	12	Clear	MB40245 (1)	6		
MB30265CLSH	18 x 8.25 x 9	457 x 210 x 229	6	Clear	MB40265 (1)	6		

Note: Bins feature a full-width hanger lip that is designed for use with hanging systems. Bins are available in carton quantities only.

Large Supply Bins — Stacking

Stackable design maximizes vertical storage efficiency. Reinforced design prevents spreading.



MB30284CLS



MB30286CLS

Part No.	Outside Dimension (in.)		Outside Dimension (mm)		Bin Carton Quantity	Color	Dividers	Divider Carton Quantity
	Length / Width / Height	Length / Width / Height	Length / Width / Height	Length / Width / Height				
MB30281CLS	20 x 12.37 x 8	508 x 314 x 203	3	Clear	-	-		
MB30283CLS	20 x 18.37 x 12	508 x 467 x 305	1	Clear	-	-		
MB30284CLS	23.8 x 8.25 x 7	606 x 210 x 178	4	Clear	-	-		
MB30286CLS	23.8 x 11 x 7	606 x 279 x 178	4	Clear	-	-		
MB30289CLS	23.8 x 18.25 x 12	606 x 464 x 305	1	Clear	-	-		
MB30348T	20.5 x 8.25 x 7	521 x 210 x 178	6	Beige	width divider included	1		

** () Recommended max # of dividers per bin = # of divider slots may be higher to provide placement flexibility

Note: Bins are available in carton quantities only. Bins above are priced per each but must be ordered in multiples of carton quantity. (For example: MB30138CLN is available in quantities of 12, 24, 36. List price refers to the price of 1 bin.) Dividers are available in carton quantities only. Dividers are sold by the carton and priced by the carton. (For example: 1 MB40120 = 24 dividers, the list price is for 24 dividers.) N/A indicates no divider available. "-" indicates divider available by special request.

Louvered Wall Panel

For use with hanging supply bins. This universal hanging surface provides easy placement and configuration of multiple sizes of bins or qwikSIGHT Baskets. Wall-mounted panels keep items out of the way, off the floor and off the work table.

Part No.	Outside Dimension (in.)		Outside Dimension (mm)		Carton Quantity	Color	Weight Capacity	
	Length / Width / Height	Length / Width / Height	Length / Width / Height	Length / Width / Height			(lb.)	(kg)
MB1819LWP	18 x 0.31 x 19	457 x 8 x 483	4	White	160	73		
MB3619LWP	36 x 0.31 x 19	914 x 8 x 483	4	White	160	73		
MB1861LWP	18 x 0.31 x 61	457 x 8 x 1549	1	White	500	227		

Note: Panel should be mounted on standard stud centers or a solid substrate (block, plywood, etc.) with fasteners in each mounting hole for maximum rigidity. Weight capacity listed is for the panel properly mounted to studs or a solid substrate. Fasteners are not included.

Bulk Supply Tub — Nesting

Ruggedly constructed, perfect for storing large bulky items.

Part No.	Outside Dimension (in.)			Outside Dimension (mm)		
	Length	Width	Height	Length	Width	Height
MB34240G	24 ¹ / ₂	19	9 ¹ / ₂	622	483	241

Note: Bins are available in carton quantities only. Bins above are priced per each but must be ordered in multiples of carton quantity.



MB34240G

Optimized for lean process.

Metro Two-Bin™



Two-Deep

As the first bin is consumed, it is placed on the top shelf or replenishment location while the second bin is pulled forward for use.



Two-Wide

For items requiring more than half of the shelf depth. As the first bin is consumed, it is placed on the top shelf or replenishment location while the second bin is used.



Two-High

As the first bin is consumed, it is placed on the top shelf or replenishment location while the contents of the lower bin are fully exposed for use.

TWO - DEEP

Part No.	Type	Fits Shelf Width	Outside Dimensions (in.) Length / Width / Height	Outside Dimensions (mm) Length / Width / Height	Bin Carton Quantity	Length Dividers**	Width Dividers**	Divider Carton Quantity
MB30220CLSH	Stack/Hang Bin	18"	7.3 x 4.12 x 3	187 x 105 x 76	24	-	N/A	6
MB30237CLSH	Stack/Hang Bin	18"	9.25 x 6 x 5	235 x 152 x 127	12	N/A	N/A	N/A
MB30224CLSH	Stack/Hang Bin	24"	10.87 x 4.12 x 4	276 x 105 x 102	12	-	N/A	-
MB30230CLSH	Stack/Hang Bin	24"	10.87 x 5.5 x 5	276 x 140 x 127	12	MB40230 (1)	-	6
MB30239CLSH	Stack/Hang Bin	24"	10.87 x 8.25 x 7	276 x 210 x 178	6	-	N/A	-
MB30235CLSH	Stack/Hang Bin	24"	10.87 x 11 x 5	276 x 279 x 127	6	MB40230 (2)	N/A	6
MB30255CLSH	Stack/Hang Bin	24"	10.87 x 16.5 x 5	276 x 419 x 127	6	MB40230 (2)	N/A	6
MB30110CLN	Nesting Bins	24"	11.6 x 2.75 x 4	295 x 70 x 102	24	N/A	N/A	N/A
MB30120CLN	Nesting Bins	24"	11.6 x 4.12 x 4	295 x 105 x 102	24	N/A	MB40120 (3)	24
MB30130CLN	Nesting Bins	24"	11.6 x 6.6 x 4	295 x 168 x 102	12	N/A	MB40130 (3)	24
MB30150CLN	Nesting Bins	24"	11.6 x 8.37 x 4	295 x 213 x 102	12	N/A	-	-
MB30170CLN	Nesting Bins	24"	11.6 x 11.12 x 4	295 x 282 x 102	12	N/A	MB40170 (3)	24

TWO - WIDE

Part No.	Type	Fits Shelf Width	Outside Dimensions (in.) Length / Width / Height	Outside Dimensions (mm) Length / Width / Height	Bin Carton Quantity	Length Dividers**	Width Dividers**	Divider Carton Quantity
MB30128CLN	Nesting Bins	18"	17.8 x 4.12 x 4	454 x 105 x 102	12	N/A	MB40120 (3)	24
MB30138CLN	Nesting Bins	18"	17.8 x 6.6 x 4	454 x 168 x 102	12	N/A	MB40130 (3)	24
MB30265CLSH	Stack/Hang Bin	18"	18 x 8.25 x 9	457 x 210 x 229	6	MB40265 (1)	N/A	6
MB30124CLN	Nesting Bins	24"	23.6 x 4.12 x 4	600 x 105 x 102	12	N/A	MB40120 (3)	24
MB30164CLN	Nesting Bins	24"	23.6 x 6.6 x 4	600 x 168 x 102	6	N/A	MB40130 (3)	24
MB30174CLN	Nesting Bins	24"	23.6 x 10.6 x 4	600 x 270 x 102	2	N/A	MB40170 (3)	24

TWO - HIGH

Part No.	Type	Fits Shelf Width	(in.) Length / Width / Height	(mm) Length / Width / Height	Bin Carton Quantity	Length Dividers**	Width Dividers**	Divider Carton Quantity
MB30284CLS	Stacking Bin	24"	23.8 x 8.25 x 7	606 x 210 x 178	4	-	-	-
MB30286CLS	Stacking Bin	24"	23.8 x 11 x 7	606 x 279 x 178	4	-	-	-
MB30289CLS	Stacking Bin	24"	23.8 x 18.25 x 12	606 x 464 x 305	1	N/A	-	-

N/A indicates no divider available. "-" indicates divider available by special request.



Flat Galvanized

Flat Stainless Steel

Louvered/Embossed Stainless Steel

Autoclavable Cart Washable Stainless Steel

Super Erecta® Solid Shelving

Setting the standard for solid shelving.

Perfect for applications involving spillage. Provides barrier between floor and bottom shelf contents to deter contamination.

- Shelf design features a 1/8" (3.2mm) raised "ship's edge" on all four sides to contain spills.
- Louvered/embossed shelf allows air circulation.
- Available in several styles and materials for a variety of applications. Shelves are constructed with 18-gauge stainless steel (Type 304) or galvanized materials.
 - **Galvanized shelves** with uncoated cast corners are ideal for applications requiring a solid shelving or work surface and minimum resistance to corrosion. Available in flat solid and louvered/embossed styles.
 - **Standard Stainless Steel solid shelves** (Type 304) with epoxy-coated cast corners address the majority of applications for solid, corrosion resistant shelves or work surfaces. Available in flat solid and louvered/embossed styles.
 - **Premium Autoclave/Cart Washable Stainless Steel solid shelves** (Type 304) feature an all-stainless construction to withstand high temperature, corrosive applications. Available in flat solid style.



Flat Solid Stainless Shelves with black powder-coated corners

Metro Tip:
Use Metro Flat Solid Shelving at the bottom of a storage unit to maintain cleanliness by providing a barrier between floor and shelf contents above.

SiteSelect Posts for Super Erecta® Solid Shelving — {10.20}

Stationary posts are fitted with adjustable leveling bolts to compensate for uneven surfaces. Mobile posts come without leveling bolt to accommodate stem casters. Special length posts are available.†

Height*		Approx. Pkd. Wt.		Cat. No. Chrome Stationary	Cat. No. Chrome Mobile	Cat. No. Stainless Stationary**	Cat. No. Stainless Mobile
(in.)	(mm)	(lbs.)	(kg)				
7 1/2	191	1/2	0.3	7P	7UP		
14 1/2	370	1	0.5	13P	13UP	13PS	13UPS
27 1/2	699	1 3/4	0.75	27P	27UP	27PS	27UPS
34 1/2	875	2	0.9	33P	33UP	33PS	33UPS
54 9/16	1385	3	1.4	54P	54UP	54PS	54UPS
62 9/16	1590	3 1/2	1.6	63P	63UP	63PS	63UPS
74 5/8	1895	4	1.8	74P	74UP	74PS	74UPS
86 5/8	2200	5	2.3	86P	86UP	86PS	86UPS
96 5/8	2454	5 1/2	2.5	***96P			

†Note: Special length posts are available, priced at next higher length plus a cutting charge. Post lengths to be specified as cut to a round number, ie: 74P cut to 69" (1753mm) . . . This will result in an overall post height with adjustment of 69 9/16" (1762mm) to 69 7/8" (1775mm).
*Height includes leveling bolt and cap.

**Stainless stationary post includes stainless leveling bolt.
***96P should not be used on units less than 24" (610mm) deep. Consult Metro Engineering for alternate recommendations.



SiteSelect™ Posts are grooved at 1" (25mm) increments and numbered at 2" (50mm) increments. Posts are double-grooved every 8" (203mm) for easy identification.

Super Erecta® Solid Shelving — {10.20}

Shelves are priced and sold individually. For standard packaging, the number of shelves per box varies by size. 14"/18" (355/457mm) wide solid shelving: less than 60" (1524mm) long (no more than 4 per carton); 60" (1524mm) long (no more than 2 per carton); 21" (530mm) wide solid shelving: less than 42" (1066mm) long (no more than 4 per carton); 42" (1066mm) or longer (no more than 2 per carton); 24" (610mm) wide solid shelving: 24", 30" (610, 760mm) long (no more than 4 per carton); 36" (914mm) or longer (no more than 2 per carton).

Width/Length (in.) (mm)	Approx. Pkd. Wt. per Shelf (lbs.) (kg)	GALVANIZED		STANDARD STAINLESS STEEL	
		Cat. No. Flat	Cat. No. Louvered/Embossed	Cat. No. Flat	Cat. No. Louvered/Embossed
14x24 355x610	10 4.5	1424FG	1424LG	1424FS	1424LS
14x30 355x760	12 5.4	1430FG	1430LG	1430FS	1430LS
14x36 355x914	14 6.4	1436FG	1436LG	1436FS	1436LS
14x42 355x1066	15 6.8	1442FG	1442LG	1442FS	1442LS
14x48 355x1219	17 7.7	1448FG	1448LG	1448FS	1448LS
14x60 355x1524	22 9.9	1460FG	1460LG	1460FS	1460LS
18x24 457x610	11 5.0	1824FG	1824LG	1824FS	1824LS
18x30 457x760	14 6.4	1830FG	1830LG	1830FS	1830LS
18x36 457x914	16 7.3	1836FG	1836LG	1836FS	1836LS
18x42 457x1066	18 8.2	1842FG	1842LG	1842FS	1842LS
18x48 457x1219	20 9.1	1848FG	1848LG	1848FS	1848LS
18x60 457x1524	24 10.9	1860FG	1860LG	1860FS	1860LS
18x72 457x1829	29 13.2	1872FG	-	1872FS	-
21x24 530x610	13 5.9	2124FG	2124LG	2124FS	2124LS
21x30 530x760	15 6.8	2130FG	2130LG	2130FS	2130LS
21x36 530x914	18 8.2	2136FG	2136LG	2136FS	2136LS
21x42 530x1066	21 9.5	2142FG	2142LG	2142FS	2142LS
21x48 530x1219	23 10.4	2148FG	2148LG	2148FS	2148LS
21x60 530x1524	26 11.8	2160FG	2160LG	2160FS	2160LS
24x24 610x610	15 6.8	2424FG	2424LG	2424FS	2424LS
24x30 610x760	17 7.7	2430FG	2430LG	2430FS	2430LS
24x36 610x914	19 8.6	2436FG	2436LG	2436FS	2436LS
24x42 610x1066	21 9.5	2442FG	2442LG	2442FS	2442LS
24x48 610x1219	24 10.9	2448FG	2448LG	2448FS	2448LS
24x60 610x1524	31 14.0	2460FG	2460LG	2460FS	2460LS
24x72 610x1829	33 15.0	2472FG	-	2472FS	-

Note: Weight Capacity (evenly distributed load): Shelves 48" (1219mm) or less in length can hold up to 800 lbs. (363kg). 60" (1524mm) long shelves can hold up to 600 lbs. (272kg). 72" (1829mm) long shelves can hold up to 300 lbs. (136kg).

Autoclavable/Cart-Washable Solid Stainless Shelving

All-stainless construction will address autoclave and cart washing applications.

Width/Length (in.) (mm)	Approx. Pkd. Wt. per Shelf (lbs.) (kg)	Cat. No. Autoclavable Stainless	Width/Length (in.) (mm)	Approx. Pkd. Wt. per Shelf (lbs.) (kg)	Cat. No. Autoclavable Stainless
14x30 355x760	12 5.4	1430NFS	21x30 530x760	15 6.8	2130NFS
14x36 355x914	14 6.4	1436NFS	21x36 530x914	18 8.2	2136NFS
14x42 355x1066	15 6.8	1442NFS	21x42 530x1066	21 9.5	2142NFS
14x48 355x1219	17 7.7	1448NFS	21x48 530x1219	23 10.4	2148NFS
14x60 355x1524	22 9.9	1460NFS	21x60 530x1524	26 11.8	2160NFS
18x24 457x610	11 5.0	1824NFS	24x24 610x610	15 6.8	2424NFS
18x30 457x760	14 6.4	1830NFS	24x30 610x760	17 7.7	2430NFS
18x36 457x914	16 7.3	1836NFS	24x36 610x914	19 8.6	2436NFS
18x42 457x1066	18 8.2	1842NFS	24x42 610x1066	21 9.5	2442NFS
18x48 457x1219	20 9.1	1848NFS	24x48 610x1219	24 10.9	2448NFS
18x60 457x1524	24 10.9	1860NFS	24x60 610x1524	31 14.0	2460NFS

Metro Tip:
Order aluminum split sleeves with stainless C-rings for corrosive, high-temperature autoclave or cart washing applications. (Cat. No. 9986S, one bag required per shelf).



Counter Unit with galvanized shelves.

Super Erecta® Counter Units — {10.35}

- To create a counter unit, select the following components:
- 2 each — 14" (355mm) deep upper shelves, listed above
- 2 each — 24" (610mm) deep lower shelves, listed above
- 2 each — upper front posts, listed below
- 2 each — lower front posts, listed below
- 2 each — 63" (1600mm) or 74" (1880mm) high back posts (page 74).

Special Posts For Counter Units — {10.35}

	Unit Height (in.) (mm)	Post Height* (in.) (mm)	Approx. Pkd. Wt. (lbs.) (kg)	Cat. No. Plated	Cat. No. Stainless
Upper Front Posts	63 1600	28 ⁵ / ₈ 727	1 ¹ / ₂ 0.7	27PF	27PFS
	74 1880	40 ⁵ / ₈ 1032	2 0.9	39PF	39PFS
Lower Front Posts	All Heights	34 ¹ / ₂ 877	2 0.9	33PM	33PMS

*Height includes leveling bolt and cap.



4" (101mm) Ledges

Shelf Ledges for Solid Shelves — {10.25}

Sturdy 4" (101mm) ledges contain items on shelves. Spring-clip tabs included for attachment.

Fits Shelf Length		Approx. Pkd. Wt. Per 6 Pieces		Cat. No. Plated	Cat. No. Stainless
(in.)	(mm)	(lbs.)	(kg)		
14	355	7½	3.4	L14WC	L14WS
18	457	9	4.1	L18WC	L18WS
21	530	10½	4.7	L21WC	L21WS
24	610	12	5.4	L24WC	L24WS
30	760	13½	6.0	L30WC	L30WS
36	914	16½	7.4	L36WC	L36WS
42	1066	19½	8.7	L42WC	L42WS
48	1219	22½	10.1	L48WC	L48WS
60	1524	30	13.5	L60WC	L60WS

*Actual ledge length is approximately 1" (25mm) shorter than nominal shelf length/width.
 Note: Standard spring-clip tabs are plated steel.



Rods with Tab in place

Rods and Tabs for Solid Shelves — {10.25}

Create a more versatile system by enclosing sides and back of an entire unit. Tabs required to attach rods to a 4-shelf unit are supplied. Additional tabs also available in bags of 6.

Rods

Min. Post Height	Rod Length		Approx. Pkd. Wt.		Cat. No. Plated
(in.)	(in.)	(mm)	(lbs.)	(kg)	
54	52	1320	1	0.5	R52FC
63	60	1524	1	0.5	R60FC
74	72	1830	1¼	0.6	R72FC
86	84	2135	1½	0.7	R84FC

Note: Standard spring-clip tabs are plated steel.

Additional Tabs

Bag of 6

Cat. No. 9184Z

Note: Standard tabs are plated steel

For applications requiring a corrosion proof solution, consult your Metro representative.



Shelf Dividers

Shelf Dividers — {10.25}

The easy way to keep shelves orderly. Eight inch (203mm) high dividers attach with spring clips (provided).

Length		Approx. Pkd. Wt. Per 6 Pieces		Cat. No. Plated	Cat. No. Stainless
(in.)	(mm)	(lbs.)	(kg)		
14	355	12	5.4	DD14FC	
18	457	13½	6.0	DD18FC	DD18FS
21	530	15	6.8	DD21FC	
24	610	16½	7.4	DD24FC	DD24FS

Solid Shelf Joining Clamp — {10.25}

Save time and money by eliminating adjacent posts and replacing with solid shelf joining clamps. Join units end-to-end, back-to-back or at right angles. Two clamps required per shelf to attach to adjacent units. Zinc. Cat. No. 9998Z



Joining Clamp

Note: Shelves with joining clamps can only be attached to shelves supported by two or more posts.



Adjustable Undershelf Slides

Adjustable Undershelf Slides — {10.25}

Create a convenient drawer system by combining a tote box with these slides. Two slides are required, and can be spaced to fit any width container.

Item	Approx. Pkd. Wt.		Cat. No. Solid
	(lbs.)	(kg)	
For 18" (457mm) wide shelf	1	0.4	US18FA
For 21" (530mm) wide shelf	1	0.4	US21FA
For 24" (610mm) wide shelf	1	0.4	US24FA

*For application-specific totes, refer to index.

Erecta Shelf® Shelving

This easy-to-assemble system puts space to work practically anywhere.

- Units go together without tools — shelf grooves simply lock into uprights at 5" (127mm) increments.
- Accessories create a truly versatile system.

Erecta Shelf® Uprights — {10.50}

Width/Length		Approx. Pkd. Wt.		Cat. No. Chrome
(in.)	(mm)	(lbs.)	(kg)	
12x53½	305x1359	7	3.2	1252C
12x63½	305x1613	8	3.3	1262C
12x73½	305x1867	9	4.1	1272C
12x88½	305x2248	11	5.0	1287C
18x53½	457x1359	8	3.3	1852C
18x63½	457x1613	9	4.1	1862C
18x73½	457x1867	11	5.0	1872C
18x88½	457x2248	13½	6.2	1887C

Packaging: 6 uprights to a carton.

Erecta Shelf® Wire Shelves — {10.50}

Width/Length		Approx. Pkd. Wt.		Cat. No. Chrome
(in.)	(mm)	(lbs.)	(kg)	
12x24	305x610	5	2.2	1224C
12x30	305x760	6	2.7	1230C
12x36	305x914	7	3.1	1236C
12x42	305x1066	8¼	3.7	1242C
12x48	305x1219	9½	4.2	1248C
12x60	305x1524	12	5.4	1260C
18x24	457x610	6½	2.9	1824C
18x30	457x760	8	3.6	1830C
18x36	457x914	10	4.5	1836C
18x42	457x1066	11	4.9	1842C
18x48	457x1219	12½	5.6	1848C
18x60	457x1524	16	7.2	1860C

Shelf Dividers — {10.50}

Keep shelves orderly with these snap-in-place, 8" (203mm) high dividers.

Shelf Width		Approx. Pkd. Wt. Per 6 Pieces		Cat. No. Plated
(in.)	(mm)	(lbs.)	(kg)	
12	305	12	5.4	DD12C
18	457	13½	6.1	DD18C
24	610	16½	7.4	DD24C



Shelf Divider

HD Super® Solid Shelving

Heavy-duty system features 16-gauge solid shelves.

- Large 1⁵/₈" (41mm) diameter posts and 2" (51mm) shelf adjustability.
- Shelf options include flat or louvered/embossed styles, and galvanized or stainless steel finishes.



HD Super Solid Stainless Shelving with black powder-coated corners

HD Super Flat Shelves — {10.65}

Width/Length (in.) (mm)		Approx. Pkd. Wt. (lbs.) (kg)		Cat. No. Galvanized	Cat. No. Stainless
18x36	457x914	21	9.5	1836HFG	1836HFS
18x42	457x1066	23	10.4	1842HFG	1842HFS
18x48	457x1219	26	11.7	1848HFG	1848HFS
18x54	457x1370	28	12.7	1854HFG	1854HFS
18x60	457x1524	31	14.0	1860HFG	1860HFS
24x36	610x914	25	11.3	2436HFG	2436HFS
24x42	610x1066	29	13.1	2442HFG	2442HFS
24x48	610x1219	32	14.4	2448HFG	2448HFS
24x54	610x1370	35	15.8	2454HFG	2454HFS
24x60	610x1524	38	17.1	2460HFG	2460HFS

HD Super® Louvered/Embossed Shelves — {10.65}

Width/Length (in.) (mm)		Approx. Pkd. Wt. (lbs.) (kg)		Cat. No. Stainless
18x36	457x914	21	9.5	1836HLS
18x42	457x1066	23	10.4	1842HLS
18x48	457x1219	26	11.7	1848HLS
18x54	457x1370	28	12.7	1854HLS
18x60	457x1524	31	14.0	1860HLS
24x36	610x914	25	11.3	2436HLS
24x42	610x1066	29	13.1	2442HLS
24x48	610x1219	32	14.4	2448HLS
24x54	610x1370	35	15.8	2454HLS
24x60	610x1524	38	17.1	2460HLS

Note: The weight capacity of a HD Super Shelf is 1,000 lbs. (457kg) per shelf, evenly distributed across shelf.

HD Super® Stationary Posts — {10.65}

Height* (in.) (mm)		Approx. Pkd. Wt. (lbs.) (kg)		Cat. No. Chrome	Cat. No. Stainless
56	1421	5.8	2.6	54HPC	54HPS
64	1624	6.3	2.9	63HPC	63HPS
76	1929	7.5	3.4	74HPC	74HPS

*Height includes leveling foot and cap.

Note: Special length posts are available. For more information, contact your Metro representative.

Packaging: 4 posts to a carton.

HD Super® Stem Caster Posts — {10.65}

Height* (in.) (mm)		Approx. Pkd. Wt. (lbs.) (kg)		Cat. No. Chrome	Cat. No. Stainless
54 ⁹ / ₁₆	1386	5.7	2.5	54UHPC	54UHPS
62 ⁹ / ₁₆	1590	6.3	2.8	63UHPC	63UHPS
74 ⁵ / ₈	1894	7.5	3.3	74UHPC	74UHPS

HD Super® Stem Casters — {10.65}

Includes donut bumpers with each caster.

Wheel Diameter (in.) (mm)	Face Diameter (in.) (mm)	Type	Wheel Tread	Approx. Pkd. Wt. (lbs.) (kg)	Cat. No.	
5	127	1 ¹ / ₂ 38.1	Swivel	Polyurethane	3 ¹ / ₂ 1.5	5HHP
5	127	1 ¹ / ₂ 38.1	Brake	Polyurethane	3 ³ / ₄ 1.5	5HHPB

Load rating per caster: 400 lbs. (182kg).



HD Super Post



HD Super Stem Caster Post



HD Super Stem Caster

Stainless solid shelving has black powder-coated corners. Galvanized solid shelving has uncoated cast corners.

HD Super® shelves, posts, and casters are not compatible with Super Erecta or Super Adjustable Super Erecta components.

HD Super® Dunnage Shelves — {10.67}

Static load capacity (uniformly distributed)

- 48" (1219mm) shelf: 3,000 lbs. (1361kg).
- 60" (1524mm) shelf: 2,400 lbs. (1089kg).
- For use on H.D. 1⁵/₈" (41mm) posts only.
- Removable wire deck.



HD Super Dunnage Shelf

Width/Length (in.) (mm)	Approx. Pkd. Wt. (lbs.) (kg)		Cat. No. Chrome	Cat. No. Metroseal 3 with Microban®	Cat. No. Stainless
18x48 457x1219	35	15.7	1848HDRC	1848HDRK3	1848HDRS
18x60 457x1524	43	19.3	1860HDRC	1860HDRK3	1860HDRS
24x48 610x1219	38	17.1	2448HDRC	2448HDRK3	2448HDRS
24x60 610x1524	47	21.1	2460HDRC	2460HDRK3	2460HDRS

Important: In stationary shelving, stability decreases as the ratio of height to width increases and when heavier loads are placed on upper shelves. Keep units as wide and low as possible, using the dunnage shelf as the bottom shelf. If two dunnage shelves are being used, both should be placed within the lower half of the unit.

Note: Not compatible with Super Erecta or Super Adjustable Super Erecta components.

HD Super® Cantilever Shelf — {10.67}

Width/Length (in.) (mm)	Approx. Pkd. Wt. (lbs.) (kg)		Cat. No. Chrome	Cat. No. Stainless
12x54 304x1372	11.8	5.3	1254CHC	1254CHS
12x60 304x1524	12.7	5.7	1260CHC	1260CHS



HD Super™ Cantilever Shelf

HD Super® Replacement Parts — {10.65}

Replacement HD Super™ Aluminum Split Sleeves with Zinc Ring
4 pair per bag
Cat. No. 9986HZ



Replacement HD Super™ Aluminum Split Sleeve

Replacement HD Super® Plastic Split Sleeves

4 pair per bag
Plastic — Cat. No. 9985H



Replacement HD Super™ Plastic Split Sleeve

Post Clamps

Cat. No. 9994HZ



Post Clamp

Replacement 5¹/₂" (140mm) Donut Bumpers

Cat. No. 9992H
Above fit 1⁵/₈" (41mm) posts only.



Replacement 5¹/₂" (140mm) Donut Bumper

3¹/₂" (89mm) Foot Plates

Cat. No. 9993HS



3¹/₂" (89mm) Foot Plate

Wall Mounting Brackets

(not shown)
Cat. No. 9984HZ

✓ Indicates antimicrobial product.



Every
process
optimized.

Every
item within
reach.



SmartWall®
SmartLever™
SmartStation™
HD Super®

WALL SHELVING, WORKSTATIONS & WORKTABLES

SmartWall Grid & Wall Shelving	82-90
PrepMate MultiStations	91-92
SmartLever Multifunctional Workstations	93-95
SmartStation Productivity Workstations	96-97
Stainless Steel Worktables & Accessories	98-101
Heavy-Duty Work Tables & Accessories	102-104



Wall-to-wall efficiency.

A unique storage and workstation system for often underutilized wall space.

Wall-mounted tracks are the foundation for attaching . . .

- Productivity stations with grids, accessories, and storage shelves
- Wall Shelving using uprights and Metro shelves
- Customizable storage space using combinations of shelving, grids, and specialized accessories

SmartWall will keep these areas cleaner and more organized.

- Prep areas
- Janitorial supply
- Above carts that are in a staging area or a storage room
- Above sinks, work tables, casework, equipment, or bulk floor storage



Flexible, Robust Design: Wall tracks and uprights are designed to interface with wood studs, plywood, concrete, and other suitable wall structures.

Easy to Adapt: Uprights and grid brackets can be easily repositioned along the track before being fastened to the wall. Shelves and accessories are easy to add and remove.

Easy to Install: Once the tracks are installed level, shelving and task stations can be quickly configured.

Easy to Clean: Shelves, shelf supports, and grids can easily be removed for thorough cleaning of walls. Wall tracks and uprights can easily be wiped clean.

Durable Finishes: Super Erecta Brite for dry environments; Metroseal 3 epoxy for wet or damp environments with built-in Microban® antimicrobial product protection to inhibit the growth of bacteria, mold, mildew, and fungus that cause odors and product degradation.



General Guidelines

Selecting Wall Tracks.

Wall track or combination of tracks must be at least 2" (51mm) longer than the desired span of shelves. 1" (25mm) on each end of the span of tracks is reserved for hardware that acts as a stop. *(Example: If 152" (3860mm) of wall track could be mounted, then the length of a shelf tier cannot exceed 150" (3810mm)).*

Uprights.

- 15" (381mm) uprights: 1 shelf tier maximum
- 30" (762mm) uprights: 3 shelf tiers maximum
- 45" (1143mm) uprights: 4 shelf tiers maximum

Shelves.

When configuring side-by-side shelving units, the adjacent shelves on the same tier must have the same depth. Minimum space between shelf tiers is 9" (229mm).

Note: When using MetroMax i shelves with SmartWall G3 shelf supports, order one adapter kit per shelf (Cat. No. M9997-4).

Shelf Supports.

Order to match up with the depth of the shelf.

Configuring Basic Wall Shelving



Ordering Guide

Single Shelving Unit

1. Select a wall track or tracks.
2. Select two uprights.
3. Select from Super Erecta wire or solid shelves, Super Erecta Pro, MetroMax Q, or MetroMax i shelves.
4. Select single shelf supports (2 per shelf)

To order the unit pictured:

Qty.	Cat. No.	
1	SW40BR	Wall Track
2	SWU45BR	Upright
1	2436BR	Wire Shelf
2	SWS24BR	Single Shelf Support
2	1836BR	Wire Shelf
4	SWS18BR	Single Shelf Support



Side-by-Side Shelving Unit

To order the unit pictured:

Qty.	Cat. No.	
1	SW56K3	Wall Track
1	SW40K3	Wall Track
4	SWU30K3	Upright
6	1830NK3	Wire Shelf
4	SWS18K3	Single Shelf Support
4	SWD18K3	Double Shelf Support



Single shelf supports are used on the ends of the wall shelf unit. Double (or Intermediate) shelf supports are used to join adjacent units.



S
Single Shelf Support



D
Double (Intermediate) Shelf Support

Configuring Basic Task Stations



General Guidelines

Selecting Wall Tracks

Wall track or combination of tracks must be at least 2" (51mm) longer than the desired span of shelves. 1" (25mm) on each end of the span of tracks is reserved for hardware that acts as a stop. (Example: If 152" (3860mm) of wall track could be mounted, then the length of a shelf tier cannot exceed 150" (3810mm).

Grids

Grids may attach directly to the uprights. Grids may not overhang the uprights by more than 6" (152mm). When uprights are not used, select the appropriate grid bracket kit based on the configuration.

Uprights and Shelf Supports

Enable standard Super Erecta, Super Erecta Pro, MetroMax Q, and MetroMax i shelves to be used as part of the task station.

Combinations of Grids and Shelves

Grids can be mounted directly behind shelves, but shelf supports and grids cannot occupy the same slots on the upright. Once the grid has been mounted to the upright, the shelf support can be mounted to its own slots and can be adjusted on 3" (76mm) increments within the grid space.

Ordering Guide

Medium-Duty Task Station —

up to 400 lbs. (181kg) unit capacity

1. Select wall track or tracks.
2. Select uprights. (two per task station)
3. Select shelves and single shelf supports. (two supports per shelf)
4. Select grid and accessories.

Notes:

- Most often shelves and grids of the same length are used together.
- Maximum unit capacity when mounted to wood studs or plywood is 400 lbs. (181kg).

Note: Refer to catalog sheet 10.42 for weight capacities in other types of wall construction.

Standard-Duty Task Station —

up to 250 lbs. (113kg) unit capacity

1. Select wall track or tracks.
2. Select grid or multiple grids.
3. Select SWGB1 grid bracket kit. (one per grid)
4. Select accessories including bulk grid shelves (pictured).

Notes:

- Maximum unit capacity when mounted to wood studs or plywood is 250 lbs. (113kg).

Note: Refer to catalog sheet 10.42 for weight capacities in other types of wall construction.

- Grids may be mounted to the wall without wall tracks using SWGB2 or WGBRKT grid bracket kits.



Consists of:

Qty.	Cat. No.	
1	SW40K3	Wall Track
2	SWU30K3	Upright
1	1836NK3	Wire Shelf
2	SWS18K3	Single Shelf Support
1	WG1836K3	Wire Grid
1	SWA1	Accessory Pack

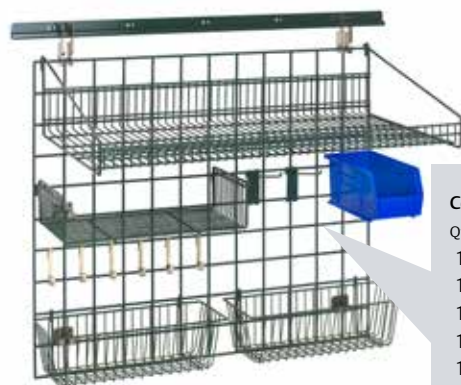

Consists of:

Qty.	Cat. No.	
1	SW40K3	Wall Track
1	WG3036K3	Wire Grid
1	SWGB1	Grid Bracket Kit
1	GS1836K3	Grid Shelf
1	SWA2	Accessory Pack

Easy Order Kits

Medium-Duty Task Station — {10.42b}

Cat. No. SWK36-1

- Bulk overhead storage space with a 1836NK3 wire shelf
- 18" x 36" (457 x 914mm) grid space
- 40" (1016mm) track
- Overall dimensions: Length x Height
40" x 31¹/₄" (1016 x 793mm)

Consists of:

Qty.	Cat. No.	
1	SW40K3	Wall Track
2	SWU30K3	Upright
2	SWS18K3	Single Shelf Support
1	1836NK3	Shelf
1	WG1836K3	Wire Grid



Standard-Duty Task Station — {10.42b}

Cat. No. SWK36-2

- Standard duty 50 lb. capacity overhead shelf
- 40" (1016mm) track and 30" x 36" (762 x 914mm) grid space
- Overall dimensions: Length x Height
40" x 39¹¹/₁₆" (1016 x 1008mm)

Consists of:

Qty.	Cat. No.	
1	SW40K3	Wall Track
1	SWG B1	Grid Bracket Kit
1	WG3036K3	Grid
1	GS1836K3	Grid Shelf



Accessory Pack Sink — {10.42b}

Cat. No. SWA1

- Packaged in one carton
- To fit minimum 18" x 36" (457 x 914mm) grid space
- Grids not included

Consists of:

Qty.	Cat. No.	
1	H210K3	Wire Basket
1	IWA-11K3	Lid Holder
1	FCH	Utensil Cylinder
1	FC1	Cylinder Holder
2	PGHK6K3	Prong Hook
6	HK23C	Standard Hook



Wire Grid and Grid Brackets Not Included.

Accessory Pack Prep — {10.42b}

Cat. No. SWA2

- Packaged in one carton
- To fit minimum 18" x 36" (457 x 914mm) grid space
- Grids not included

Consists of:

Qty.	Cat. No.	
1	PBA-GSDK3	Small Shelf
2	H210K3	Wire Basket
1	DD3722A	Bin Holder
1	MB30230CLSH	Small Bin
2	PGHK6K3	Prong Hook
6	HK23C	Standard Hook



Wire Grid and Grid Brackets Not Included.



Complete Smartwall Sink Kit

Cat. No. SWK36-1A1-SR

- Packaged in one carton
- Includes as shown.
Contents of SWK36-1, SWA1



Complete Smartwall Prep Kit

Cat. No. SWK36-1A2-SR

- Packaged in one carton
- Includes as shown.
Contents of SWK36-1, SWA2

SmartWall Components — {10.42}



Wall Track

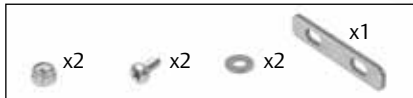

Hardware

Wall Tracks (minimum one per system)

- Joiner plates and stop fastener hardware included. Does not include hardware to mount wall tracks to the wall.
- Replacement joiner plate (1) and stop fastener hardware (2 sets): Cat. No. RPTRK-HDWE

Actual Length (in.)	Actual Length (mm)	Actual Depth (in.)	Actual Depth (mm)	Actual Width (in.)	Actual Width (mm)	Approx. Pkd. Wt. (lbs.)	Approx. Pkd. Wt. (kg)	Cat. No. Super Erecta Brite	Cat. No. Metroseal 3
40	1016	3/4	19	1 9/16	40	5.0	2.2	SW40BR	SW40K3
56	1423	3/4	19	1 9/16	40	6.0	2.6	SW56BR	SW56K3
72	1829	3/4	19	1 9/16	40	7.0	3.1	SW72BR	SW72K3

*Note: Tracks can be cut to length, but Metro does not provide this service. Touch-up paint for Metroseal 3 tracks is available.

Uprights (For medium-duty applications, minimum two per system. Sold by the piece)

- Built-in slots allow shelf supports and grids to attach without tools or hardware.
- 1 1/2" (38mm) slot spacing allows shelves and grids to be adjusted on 1 1/2" (38mm) increments

Actual Length (in.)	Actual Length (mm)	Actual Width (in.)	Actual Width (mm)	Actual Depth (in.)	Actual Depth (mm)	Number of Slots	Approx. Pkd. Wt. (lbs.)	Approx. Pkd. Wt. (kg)	Cat. No. Super Erecta Brite	Cat. No. Metroseal 3
16	406	1 1/8	29	1 7/8	48	7	1.8	0.8	SWU15BR	SWU15K3
31	787	1 1/8	29	1 7/8	48	17	3.5	1.5	SWU30BR	SWU30K3
44 1/2	1130	1 1/8	29	1 7/8	48	26	5.3	2.3	SWU45BR	SWU45K3

Shelf Supports (Sold by the piece)

- Mount directly to slotted uprights. Suitable for use with Super Erecta, MetroMax Q, and MetroMax i shelves.
- Single shelf supports are used on each end of a single unit or side-by-side unit.
- Double (intermediate) shelf supports are used when configuring side-by-side wall shelving units.

Single Shelf Supports

Fits shelf depth	Actual Length (in.)	Actual Length (mm)	Actual Width (in.)	Actual Width (mm)	Actual Height (in.)	Actual Height (mm)	Approx. Pkd. Wt. (lbs.)	Approx. Pkd. Wt. (kg)	Cat. No. Super Erecta Brite	Cat. No. Metroseal 3
14" (355mm)	16 9/16	421	1 1/2	38	8 3/16	208	2.5	1.1	SWS14BR	SWS14K3
18" (457mm)	20 9/16	522	1 1/2	38	8 3/16	208	3.0	1.3	SWS18BR	SWS18K3
21" (530mm)	23 9/16	598	1 1/2	38	8 3/16	208	3.5	1.5	SWS21BR	SWS21K3
24" (610mm)	26 9/16	675	1 1/2	38	8 3/16	208	3.5	1.5	SWS24BR	SWS24K3

*Note: Replacement plastic sleeve for shelf support. Cat. No. RP-SPLV.
 Note: When using MetroMax i shelves with shelf supports, please order 1 adapter kit per shelf. Cat. No. M9997-4

Double (Intermediate) Shelf Supports

Fits shelf depth	Actual Length (in.)	Actual Length (mm)	Actual Width (in.)	Actual Width (mm)	Actual Height (in.)	Actual Height (mm)	Approx. Pkd. Wt. (lbs.)	Approx. Pkd. Wt. (kg)	Cat. No. Super Erecta Brite	Cat. No. Metroseal 3
14" (355mm)	16 9/16	421	1 1/2	38	8 3/16	208	2.5	1.1	SWD14BR	SWD14K3
18" (457mm)	20 9/16	522	1 1/2	38	8 3/16	208	3.0	1.3	SWD18BR	SWD18K3
21" (530mm)	23 9/16	598	1 1/2	38	8 3/16	208	3.5	1.5	SWD21BR	SWD21K3
24" (610mm)	26 9/16	675	1 1/2	38	8 3/16	208	3.5	1.5	SWD24BR	SWD24K3

*Note: Replacement plastic sleeve for shelf support. Cat. No. RP-SPLV.
 Note: When using MetroMax i shelves with shelf supports, please order 1 adapter kit per shelf. Cat. No. M9997-4

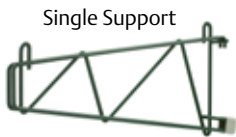
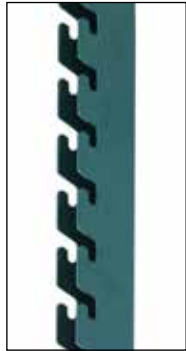

Single Support

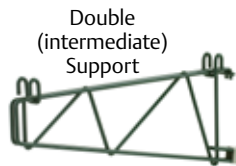

Double (intermediate) Support

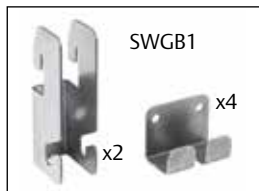

SWGB1

x4



SWGB2

WGBRKT

x6

x6

Grid Mounting Brackets (for standard-duty applications without uprights)

- Use to connect the grid to the wall when uprights are not used. One kit required per grid.

Description	Approx. Pkd. Wt. (lbs.)	Approx. Pkd. Wt. (kg)	Cat. No.
Bracket kit to connect grid to wall track; includes (2) top and (4) bottom (stainless steel)	2.0	0.9	SWGB1
Direct wall mount bracket kit; consists of (6) bottom brackets (stainless steel)	2.0	0.9	SWGB2
Direct wall mount bracket kit; consists of (6) black plastic brackets	2.0	0.9	WGBRKT

Wire Grids

- Brackets to mount the grid to the wall track or the wall are not included and can attach directly to uprights without brackets or tools.
- Grid openings measure approximately 3" x 3" (76 x 76mm)

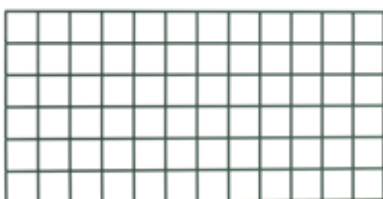

Grid: 18" x 36" (457 x 914mm)

Width x Length (in.)	Width x Length (mm)	Approx. Pkd. Wt. (lbs.)	Approx. Pkd. Wt. (kg)	Cat. No. Plated	Cat. No. Metroseal 3
18x30	457x760	7.5	3.3	—	WG1830K3
18x36	457x914	9.0	4.1	WG1836BR	WG1836K3
18x48	457x1219	12.0	5.4	WG1848BR	WG1848K3
18x60	457x1524	14.0	6.4	WG1860BR	WG1860K3
24x36	610x914	12.0	5.4	—	WG2436K3
24x48	610x1219	15.5	7.0	—	WG2448K3
30x36	760x914	12.8	5.8	—	WG3036K3
30x48	760x1219	16.5	7.5	—	WG3048K3
33x54	838x1370	21.0	9.5	PBA-GPC	—

*Note: Can be retrofitted to original MetroMax and MetroMax Q shelving.

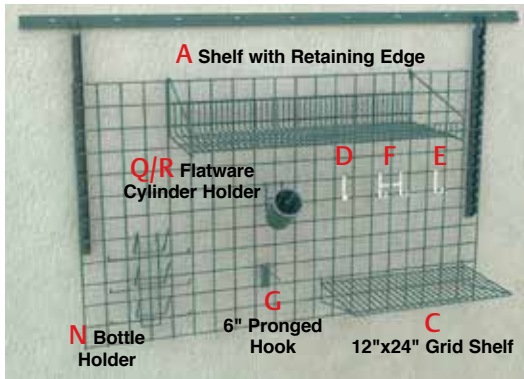

Accessories for Grids — [10.42]

Shelves for Grids

		Width/Length/Height (in.)	(mm)	Approx. Pkd. Wt. (lbs.) (kg)	Cat. No. Plated	Cat. No. Metroseal 3
A	14"x36" (356x914mm) Shelf w/Retaining Edge	15 ⁵ / ₈ x35 ¹ / ₄ x7 ³ / ₄	391x895x197	12 4.5	—	GS1436K3
A	14"x48" (356x1219mm) Shelf w/Retaining Edge	15 ⁵ / ₈ x47 ¹ / ₄ x7 ³ / ₄	391x1200x197	16 6.0	—	GS1448K3
A	18"x30" (457x762mm) Shelf w/Retaining Edge	19 ⁵ / ₈ x29 ¹ / ₄ x7 ³ / ₄	492x743x197	15 5.6	—	GS1830K3
A	18"x36" (457x914mm) Shelf w/Retaining Edge	19 ⁵ / ₈ x35 ¹ / ₄ x7 ³ / ₄	492x895x197	18 6.7	—	GS1836K3
A	18"x48" (457x1219mm) Shelf w/Retaining Edge	19 ⁵ / ₈ x47 ¹ / ₄ x7 ³ / ₄	492x1200x197	24 9.0	—	GS1848K3
B	Light-Duty Shelf with Side Ledges	9 W.x18 ¹ / ₂ L.	228 W.x470 L.	4 1.8	PBA-GSD	PBA-GSDK3
C	Flat Grid Shelf — 24" (610mm)	12 ¹ / ₁₆ x24x4	322x610x102	7 2.6	—	FGS1224K3

Hooks

		Width/Length/Height (in.)	(mm)	Approx. Pkd. Wt. (lbs.) (kg)	Cat. No. Chrome	Cat. No. Metroseal
D	Small Hook	1 ¹ / ₄ x3 ¹ / ₂	32x89		HK23C	—
E	Large Hook	2x3 ¹ / ₂	50x89		HK25C	—
F	Double Large Hook	2x3 ¹ / ₂	50x89		HK26C	—
G	6" (152mm) Pronged Hook	1 ¹ / ₄ x7 ³ / ₈ x5 ⁵ / ₈	32x194x92	.3 0.1	—	PGHK6K3

Baskets

		Width/Length/Height (in.)	(mm)	Approx. Pkd. Wt. (lbs.) (kg)	Cat. No. Chrome	Cat. No. Metroseal 3
H	Small Basket	13 ³ / ₈ x5x7	345x127x180	8.5 4	H209C	H209K3
H	5" (127mm) Deep Large Basket	17 ⁷ / ₈ x7 ¹ / ₂ x5	440x190x127	7 3	H210C	H210K3
H	10" (254mm) Deep Large Basket	17 ⁷ / ₈ x7 ¹ / ₂ x10	440x190x255	11 5	H212C	H212K3

Bins and Holders

		Width/Length/Height (in.)	(mm)	Approx. Pkd. Wt. (lbs.) (kg)	Cat. No.
I	Clear Bin Packed 12/Ctn.	10 ⁷ / ₈ x5 ¹ / ₂ x5	279x140x127	1 0.45	MB30230CLSH
I	Clear Bin Packed 6/Ctn.	10 ⁷ / ₈ x11x5	279x280x127	1.5 0.68	MB30235CLSH
I	Clear Bin Packed 12/Ctn.	14 ³ / ₄ x8 ¹ / ₄ x7	375x210x180	2 0.91	MB30240CLSH
J	Single Bin Holder	3x ¹ / ₂ (LxH)	76x13 (LxH)	0.5 0.23	DD3722A
J	Small Bin Holder	11x3 (LxH)	280x76 (LxH)	1 .45	PBA-1BH
J	Large Bin Holder	22x3	559x76 (LxH)	2 .91	PBA-2BH

Drying Rack Accessories

		Width/Length/Height (in.)	(mm)	Pkd. Wt. (lbs.) (kg)	Cat. No. Plated	Cat. No. Metroseal 3
K	Slanted Lid Holder/Drying Shelf	14 ¹ / ₈ x20 ³ / ₄ x12 ¹ / ₈	359x527x307	5.0 2.3	—	IWA-S11K3
L	Lid Holder/Drying Shelf	8 ¹ / ₄ x13 ¹ / ₂ x4 ¹ / ₂	210x343x114	2 0.9	—	IWA-11K3
M	Tray Drying Rack	14 ⁹ / ₁₆ x46 ¹ / ₄ x10 ³ / ₁₆	371x1175x259	12.0 5.4	—	TDR48K3
N	6-Prong Bottle Holder	14 ⁷ / ₈ x5 ¹ / ₈ x11	378x130x279	2.3 0.8	—	BH6K3

Utensil Holders

		Width/Length/Height (in.)	(mm)	Approx. Pkd. Wt. (lbs.) (kg)	Cat. No. Plated	Cat. No. Metroseal 3
O	Large Utensil Holder	10 ¹ / ₂ x10 ³ / ₈ x4	267x264x102	4 1.8	—	IWA-12K3
P	Small Utensil Holder	4 ³ / ₈ x10 ³ / ₈ x4	111x264x102	4 1.8	—	IWA-14K3
Q	Flatware/Instrument Cylinder	4 ⁵ / ₁₆ x4 ⁵ / ₁₆ x5 ¹ / ₂	109x109x140	0.3 0.1	—	FC1
R	Cylinder Holder	2 ⁵ / ₈ x5 ⁷ / ₈ x5 ³ / ₄	67x149x146	1.0 0.5	—	FCH

Miscellaneous Accessories

		Width/Length/Height (in.)	(mm)	Approx. Pkd. Wt. (lbs.) (kg)	Cat. No. Plated	Cat. No. Metroseal 3
S	Spice Rack/Utility Shelf	5 ¹ / ₄ x22 ¹ / ₂ x4	133x571x102	3.5 1.6	SR24BR	SR24K3
T	Insert Pan Holder	7 ¹ / ₂ x12 ¹ / ₂ x4	190x317x102	2.3 1.0	STP3BR	—
U	Hanging File Holder	6 ¹ / ₄ W.x12 ¹ / ₂ L.	159 W.x317 L.	3 1.4	PBA-PFH	—
V	Glove Box Holder (Vertical)	6 ³ / ₈ W.x10 ¹ / ₂ H.	162 W.x267H.	2 0.9	—	GBHVK3
		Inside Dimensions 5 ⁷ / ₈ " W.x3 ¹ / ₁₆ " D. [267mm W.x87mm D.]				
W	Sticker Roll Holder	Overall Dimensions (Width/Length/Height): 5" x 18 ¹ / ₂ " x 3 ³ / ₄ " (127 x 470 x 95mm)				SRD18K3
		Note: Tube dimension for holding rolls: 14 ³ / ₄ " (375mm). Fits up to 6 ¹ / ₄ " (159mm) diameter roll.				

Wall Mounts

An ideal method for storing items overhead or above work surfaces.

- Brackets accommodate all Super Erecta® sizes and types of shelves.
- Use double supports to mount adjacent shelves, single supports at ends.
- Metal caps to cover openings are provided.
- Available in chrome, Metroseal 3 or stainless steel.

Post-Type Wall Mounts — {10.40}

Standard Units

Post-type wall mounts are available in pre-packaged “End Units” and “Mid Units”; complete with all needed components except shelves, wall bolts or screws, which must be selected according to type of wall.

A “End Unit” consists of two posts with wall mounting brackets, and two single shelf supports for each shelf level.

B “Mid Unit” consists of one post with brackets and double support for each shelf.

Note: If shelving is to be the length of one shelf, order End Unit only.

If two-shelf lengths, order one End Unit and one Mid Unit; three lengths, one End and two Mid Units; four lengths, one End and three Mid Units; etc.

For 14" (355mm) Shelf Width

Shelf Levels	Approx. Pkd. Wt.		Cat. No. End Unit	Approx. Pkd. Wt.		Cat. No. Mid Unit
	(lbs.)	(kg)		(lbs.)	(kg)	
1	7	3.2	SW21C	5	2.3	AW21C
2	14	6.4	SW23C	9	4.1	AW23C
3	22	10	SW25C	14	6.4	AW25C
4	28	12.7	SW26C	18	8.2	AW26C

For 18" (457mm) Shelf Width

Shelf Levels	Approx. Pkd. Wt.		Cat. No. End Unit	Approx. Pkd. Wt.		Cat. No. Mid Unit
	(lbs.)	(kg)		(lbs.)	(kg)	
1	7	3.2	SW31C	5	2.3	AW31C
2	14	6.4	SW33C	11	5	AW33C
3	22	10	SW35C	17	8	AW35C
4	28	12.7	SW36C	21	9.5	AW36C

For 21" (530mm) Shelf Width

Shelf Levels	Approx. Pkd. Wt.		Cat. No. End Unit	Approx. Pkd. Wt.		Cat. No. Mid Unit
	(lbs.)	(kg)		(lbs.)	(kg)	
1	8	3.6	SW41C	6	2.7	AW41C
2	16	7.3	SW43C	12	5.5	AW43C
3	25	11.3	SW45C	18	8.2	AW45C
4	32	14.4	SW46C	23	10.4	AW46C

For 24" (610mm) Shelf Width

Shelf Levels	Approx. Pkd. Wt.		Cat. No. End Unit	Approx. Pkd. Wt.		Cat. No. Mid Unit
	(lbs.)	(kg)		(lbs.)	(kg)	
1	9	4.1	SW51C	6	2.7	AW51C
2	18	8.2	SW53C	12	5.5	AW53C
3	28	12.7	SW55C	19	9	AW55C
4	36	16	SW56C	24	10.9	AW56C

*Note: User should determine that wall material and method of mounting are suitable to support the shelves and their contents. Mounting hardware not included.



Post-Type Wall Mount Installation
*Shelf supports are chrome-plated.

Post-Type Wall Mounts

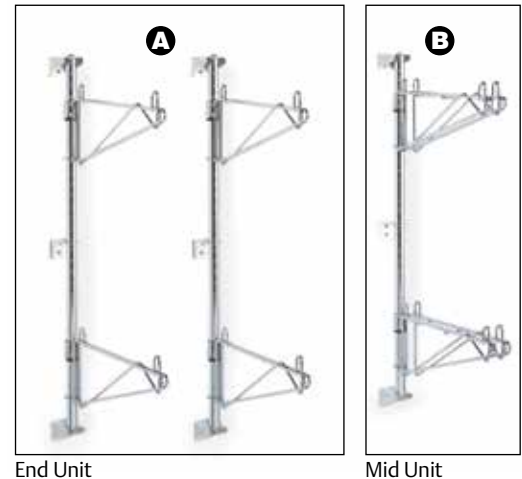

End Unit

Mid Unit

Maximum Load Rating: 250 lbs. (113kg) per shelf, not to exceed 250 lbs. (113kg) per unit.

Metro Tip:

Have you looked at your walls lately? Unused wall space provides the perfect opportunity for a significant increase in storage capacity. Metro offers a complete line of wall shelving systems to maximize storage density.

See page 42 for Super Erecta shelves.

Posts and Brackets — {10.40}

Two end brackets (BES) are supplied with each of these double-footed posts. One intermediate bracket (BCS) is supplied with 33PDF posts and two are supplied with 54PDF and 63PDF posts. Order desired number/style of shelf supports below.

Post Height (in.) (mm)	Description	Approx. Pkd. Wt. (lbs.) (kg)	Cat. No. Chrome	Cat. No. Metroseal 3 with Microban®	Cat. No. Stainless
13 ³ / ₈ 350	Post for 1 tier	1 ¹ / ₄ 0.6	13PDF	13PDFK3	13PDFS
33 ³ / ₈ 854	Post for 2 tiers	2 ³ / ₄ 1.2	33PDF	33PDFK3	33PDFS
54 1370	Post for 3 or more tiers	5 2.3	54PDF	54PDFK3	54PDFS
62 1573	Post for 4 or more tiers	6 2.7	63PDF	63PDFK3	63PDFS
	End Bracket	1/2 0.2	BES	BESK3	SBES
	Intermediate Bracket	1/2 0.2	BCS	BCSK3	SBCS

Note: User should determine that wall material and method of mounting are suitable to support the shelves and their contents. Mounting hardware not included. Order shelves from page 42.

Corner Adapters for MetroMax i shelving
Use when joining MetroMax i shelves with wire shelf supports. Box of 4. Use one box per shelf. Cat. No. M9997-4

Corner Adapters for MetroMax 4 shelving
Use when joining MetroMax 4 shelves with wire shelf supports. Box of 4. Use one box per shelf. Cat. No. MAX4-9997-4

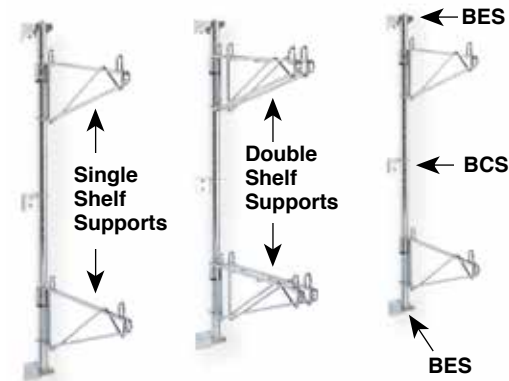

Typical configuration using two end units and one mid unit

Maximum Load Rating:
250 lbs. (113kg) per shelf,
not to exceed 250 lbs.
(113kg) per unit.

See page 42 for Super Erecta shelves.

Metro Tip:
MetroMax Q, MetroMax 4, and MetroMax i shelves can be used with Super Erecta Post Mounting Shelf Supports and Direct Wall Mounts.

Shelf Supports — Post Mounting — {10.40}

Single — Two required per shelf (one at each end.)

Shelf Width (in.) (mm)	Approx. Pkd. Wt. (lbs.) (kg)	Cat. No. Chrome	Cat. No. Metroseal 3 with Microban®	Cat. No. Stainless
14 355	2 0.9	1WS14C	1WS14K3	1WS14S
18 457	2 0.9	1WS18C	1WS18K3	1WS18S
21 530	2 ¹ / ₂ 1.1	1WS21C	1WS21K3	1WS21S
24 610	3 1.4	1WS24C	1WS24K3	1WS24S

Double — For run of multiple shelves.

Shelf Width (in.) (mm)	Approx. Pkd. Wt. (lbs.) (kg)	Cat. No. Chrome	Cat. No. Metroseal 3 with Microban®	Cat. No. Stainless
14 355	3 1.4	2WS14C	2WS14K3	2WS14S
18 457	3 ³ / ₄ 1.7	2WS18C	2WS18K3	2WS18S
21 530	4 ¹ / ₄ 1.9	2WS21C	2WS21K3	2WS21S
24 610	4 ¹ / ₂ 2.0	2WS24C	2WS24K3	2WS24S

Order shelves from page 42.

Direct Wall Mounts — {10.40}

Each consists of one shelf support and mounting plate, with two shelf collar caps. Use single support at shelf ends; double support for adjoining shelves.

Single — Two required per shelf.

Shelf Width (in.) (mm)	Approx. Pkd. Wt. (lbs.) (kg)	Cat. No. Chrome	Cat. No. Metroseal 3 with Microban®	Cat. No. Stainless
14 355	1 ¹ / ₂ 0.7	1WD14C	1WD14K3	1WD14S
18 457	2 0.9	1WD18C	1WD18K3	1WD18S
21 530	2 0.9	1WD21C	1WD21K3	1WD21S
24 610	2 ¹ / ₄ 1.0	1WD24C	1WD24K3	1WD24S

Double

Shelf Width (in.) (mm)	Approx. Pkd. Wt. (lbs.) (kg)	Cat. No. Chrome	Cat. No. Metroseal 3 with Microban®	Cat. No. Stainless
14 355	3 1.4	2WD14C	2WD14K3	2WD14S
18 457	3 1.4	2WD18C	2WD18K3	2WD18S
21 530	4 1.8	2WD21C	2WD21K3	2WD21S
24 610	4 ¹ / ₂ 2.0	2WD24C	2WD24K3	2WD24S

Note: User should determine that wall material and method of mounting are suitable to support the shelves and their contents.



Single Shelf Support



Double Shelf Support



Hole Plugs — {10.06}

This chrome-plated cover is used to fill shelf-corner openings. Use wherever posts have been eliminated by "S" hooks. Cat. No. 9997C

✓ Indicates antimicrobial product.

NSF Note: Wall shelving is NSF listed.



Wall Mount Brackets shown with MetroMax i Open Frame and Drop-In Basket.

Direct Wall Mount Shelving — {9.20}

Use standard Super Erecta stainless steel direct wall mount shelf supports with MetroMax shelves or open frames with wire drop in baskets. Order one MetroMax corner adapter kit with each shelf or shelf frame. Shelf supports are sold individually.

Single — Use at shelf ends; two are required for a stand-alone shelf.

Shelf Width		Approx. Pkd. Wt.		Cat. No.
(in.)	(mm)	(lbs.)	(kg)	Stainless Steel
18	457	2	0.9	1WD18S
24	610	2¼	1.0	1WD24S

Double — When constructing a run of shelves, use double shelf supports to join adjacent shelves.

Shelf Width		Approx. Pkd. Wt.		Cat. No.
(in.)	(mm)	(lbs.)	(kg)	Stainless Steel
18	457	3	1.4	2WD18S
24	610	4¼	2.0	2WD24S

For MetroMax i Open Frame and Drop-In Basket, see page 27.

Corner Adapters for MetroMax i shelving

Use when joining MetroMax i shelves with wire shelf supports. Box of 4. Use one box per shelf. Cat. No. **M9997-4**

Corner Adapters for MetroMax 4 shelving

Use when joining MetroMax 4 shelves with wire shelf supports. Box of 4. Use one box per shelf. Cat. No. **MAX4-9997-4**



Wall Mounts with Shelf (Shelf sold separately, see page 77)

Erecta Shelf® Wall Mounts — {10.56}

Used to create wall-mounted shelving units with 12" (305mm) or 18" (457mm) Erecta shelves of any length.

- Models are available to accommodate from one to five shelves. (Each mount consists of two shelf supports and mounting brackets.)
- Wall bolts or screws not included; they must be selected according to type of wall.
- Order shelves from page 77.

Width	Height	Capacity	Approx. Pkd. Wt. (Pr.)		Cat. No.
			(lbs.)	(kg)	
12	10¾	1 Shelf	2½	1.1	12WB1C
12	20⅜	1 to 3 Shelves	5	2.3	12WB3C
12	30⅜	1 to 5 Shelves	7¼	3.2	12WB5C
18	11¾	1 Shelf	3	1.4	18WB1C
18	21⅝	1 to 3 Shelves	6	2.7	18WB3C
18	31⅝	1 to 5 Shelves	8½	3.8	18WB5C

For additional mounting brackets (single) order Cat. No. **9975C**

Double mounting brackets are also available for use where continuous wall shelving is to be installed. Cat. No. **9976C**

Load Rating: 200 lbs. (91kg) per shelf, not to exceed 200 lbs. (91kg) per unit.

Units must be secured to sufficient wall support structure.

Erecta Shelf® Wall Kit — {10.56}

Kit includes two shelves, shelf supports, and mounting brackets. Wall bolts and screws not included; they must be selected according to type of wall. Chrome.

Shelf Length	Overall Length	Shelf Width	Overall Width	Overall Height	Approx. Pkd. Wt.	Cat. No.	
(in.)	(mm)	(in.)	(mm)	(in.)	(lbs.)	(kg)	
24	26¼	12	13	21	18½	8.3	12WS12C
36	38¼	12	13	21	25¼	11.3	12WS32C
48	50¼	12	13	21	32	14.4	12WS52C

Kit packaged in one box and UPS shippable.

Load Rating: 200 lbs. (91kg) per shelf, not to exceed 200 lbs. (91kg) per unit.

Units must be secured to sufficient wall support structure.



12WS12C
Erecta Shelf® Wall Kit

By your side until the job is done.



SUPPORTS GOOD
HACCP

*Patent Pending.



Versatile.

Prepare raw meats like chicken, pork, beef or seafood. Create an efficient versatile workspace using standard steam table and food pans.



*qwikSet
easy height
adjustment
option.*



Efficient.

From farm to table, chop, dice & slice through vegetables with the highest efficiency. Utilize the PrepMate rail system with stock below on one side and push prepped food directly into waiting pans on the other.

20%
INCREASE

* Penn State University Center
for Food Innovation testing.



qwikSet.

Click. Click. Set.
Being comfortable is
really that simple.

Go with **NEW qwikSet**— The ultimate work surface adjustment feature. Just depress the orange tab to raise or lower the work surface height for your ideal ergonomic prep position.

PREPMATE™ MULTISTATION



PrepMate Original Part #	PrepMate QwikSet Part #	Width/Length	Shelf Size	Top Shelf	Bottom Shelf
MS1824-FGFG	MSQ1824-FGFG	19.4"x26" (493mm x 660mm)	18"x24" (457mm x 610mm)	Solid Galvanized	Solid Galvanized
MS1824-FGBR	MSQ1824-FGBR	19.4"x26" (493mm x 660mm)	18"x24" (457mm x 610mm)	Solid Galvanized	Brite Zinc Wire
MS1824-FSFS	MSQ1824-FSFS	19.4"x26" (493mm x 660mm)	18"x24" (457mm x 610mm)	Solid Stainless Steel	Solid Stainless Steel
MS1824-FSNK	-	19.4"x26" (493mm x 660mm)	18"x24" (457mm x 610mm)	Solid Stainless Steel	MetroSeal 3 Epoxy Wire
MS1824-BRBR	-	19.4"x26" (493mm x 660mm)	18"x24" (457mm x 610mm)	Brite Zinc Wire	Brite Zinc Wire
MS1824-PRPR	-	19.4"x26" (493mm x 660mm)	18"x24" (457mm x 610mm)	SuperErecta Pro Hybrid Mat	SuperErecta Pro Hybrid Mat
MS1824-FSPR	-	19.4"x26" (493mm x 660mm)	18"x24" (457mm x 610mm)	Solid Stainless Steel	SuperErecta Pro Hybrid Mat
MS1824-NKNK	-	19.4"x26" (493mm x 660mm)	18"x24" (457mm x 610mm)	MetroSeal 3 Epoxy Wire	MetroSeal 3 Epoxy Wire
MS1830-FGFG	MSQ1830-FGFG	19.4"x32" (493mm x 812mm)	18"x30" (457mm x 762mm)	Solid Galvanized	Solid Galvanized
MS1830-FGBR	MSQ1830-FGBR	19.4"x32" (493mm x 812mm)	18"x30" (457mm x 762mm)	Solid Galvanized	Brite Zinc Wire
MS1830-FSFS	MSQ1830-FSFS	19.4"x32" (493mm x 812mm)	18"x30" (457mm x 762mm)	Solid Stainless Steel	Solid Stainless Steel
MS1830-FSNK	-	19.4"x32" (493mm x 812mm)	18"x30" (457mm x 762mm)	Solid Stainless Steel	MetroSeal 3 Epoxy Wire
MS1830-BRBR	-	19.4"x32" (493mm x 812mm)	18"x30" (457mm x 762mm)	Brite Zinc Wire	Brite Zinc Wire
MS1830-PRPR	-	19.4"x32" (493mm x 812mm)	18"x30" (457mm x 762mm)	SuperErecta Pro Hybrid Mat	SuperErecta Pro Hybrid Mat
MS1830-FSPR	-	19.4"x32" (493mm x 812mm)	18"x30" (457mm x 762mm)	Solid Stainless Steel	SuperErecta Pro Hybrid Mat
MS1830-NKNK	-	19.4"x32" (493mm x 812mm)	18"x30" (457mm x 762mm)	MetroSeal 3 Epoxy Wire	MetroSeal 3 Epoxy Wire
MS1836-FGFG	MSQ1836-FGFG	19.4"x38" (493mm x 914mm)	18"x36" (457mm x 914mm)	Solid Galvanized	Solid Galvanized
MS1836-FGBR	MSQ1836-FGBR	19.4"x38" (493mm x 914mm)	18"x36" (457mm x 914mm)	Solid Galvanized	Brite Zinc Wire
MS1836-FSFS	MSQ1836-FSFS	19.4"x38" (493mm x 914mm)	18"x36" (457mm x 914mm)	Solid Stainless Steel	Solid Stainless Steel
MS1836-FSNK	-	19.4"x38" (493mm x 914mm)	18"x36" (457mm x 914mm)	Solid Stainless Steel	MetroSeal 3 Epoxy Wire
MS1836-BRBR	-	19.4"x38" (493mm x 914mm)	18"x36" (457mm x 914mm)	Brite Zinc Wire	Brite Zinc Wire
MS1836-PRPR	-	19.4"x38" (493mm x 914mm)	18"x36" (457mm x 914mm)	SuperErecta Pro Hybrid Mat	SuperErecta Pro Hybrid Mat
MS1836-FSPR	-	19.4"x38" (493mm x 914mm)	18"x36" (457mm x 914mm)	Solid Stainless Steel	SuperErecta Pro Hybrid Mat
MS1836-NKNK	-	19.4"x38" (493mm x 914mm)	18"x36" (457mm x 914mm)	MetroSeal 3 Epoxy Wire	MetroSeal 3 Epoxy Wire
MS1848-FGFG	MSQ1848-FGFG	19.4"x50" (493mm x 1270mm)	18"x48" (457mm x 1219mm)	Solid Galvanized	Solid Galvanized
MS1848-FGBR	MSQ1848-FGBR	19.4"x50" (493mm x 1270mm)	18"x48" (457mm x 1219mm)	Solid Galvanized	Brite Zinc Wire
MS1848-FSFS	MSQ1848-FSFS	19.4"x50" (493mm x 1270mm)	18"x48" (457mm x 1219mm)	Solid Stainless Steel	Solid Stainless Steel
MS1848-FSNK	-	19.4"x50" (493mm x 1270mm)	18"x48" (457mm x 1219mm)	Solid Stainless Steel	MetroSeal 3 Epoxy Wire
MS1848-BRBR	-	19.4"x50" (493mm x 1270mm)	18"x48" (457mm x 1219mm)	Brite Zinc Wire	Brite Zinc Wire
MS1848-PRPR	-	19.4"x50" (493mm x 1270mm)	18"x48" (457mm x 1219mm)	SuperErecta Pro Hybrid Mat	SuperErecta Pro Hybrid Mat
MS1848-FSPR	-	19.4"x50" (493mm x 1270mm)	18"x48" (457mm x 1219mm)	Solid Stainless Steel	SuperErecta Pro Hybrid Mat
MS1848-NKNK	-	19.4"x50" (493mm x 1270mm)	18"x48" (457mm x 1219mm)	MetroSeal 3 Epoxy Wire	MetroSeal 3 Epoxy Wire

PrepMate **qwikSet** Easy Order Kits with Accessories



Part #	Shelf Types
MSQ1830-FSFS-PK2	Stainless / Stainless
MSQ1836-FSFS-PK2	Stainless / Stainless
MSQ1848-FSFS-PK2	Stainless / Stainless

Includes: (2) Magic Rings, (1) 18"x24" White HDPE Cutting Board, Cutting Board Holder, Pan Holder, Knife Holder



Part #	Shelf Types
MSQ1830-FGFG-PK2	Galvanized / Galvanized
MSQ1836-FGFG-PK2	Galvanized / Galvanized
MSQ1848-FGFG-PK2	Galvanized / Galvanized

Includes: (2) Magic Rings, (1) 18"x24" White HDPE Cutting Board, Cutting Board Holder, Pan Holder, Knife Holder



Part #	Shelf Types
MSQ1830-FGBR-PK2	Galvanized / Brite
MSQ1836-FGBR-PK2	Galvanized / Brite
MSQ1848-FGBR-PK2	Galvanized / Brite

Includes: (2) Magic Rings, (1) 18"x24" White HDPE Cutting Board, Cutting Board Holder, Pan Holder, Knife Holder



PrepMate Accessories & Kits

Part #	Description	Size
MS-CBE	Cutting Board Holder	18.75"x19.25"x5" (476mm x 489mm x 127mm)
MS-CB1824-W	Cutting Board	18"x24" (457mm x 610mm x 12.7mm)
MS-RING	Magic Ring	7"x13" (178mm x 330mm)
MS-CSBH	Sanitation Bucket Holder	7"x13" (178mm x 330mm)
MS-SPH*	Pan Holder	19"x22.5"x16" (483mm x 572mm x 406mm)
MS-KNIFE	Encased Knife Holder	2"x10"x12" (51mm x 254mm x 305mm)
MS-UB	18" Utensil Bar	3"x18" (76mm x 457mm)
5PTL-NB	5" Total Lock Caster	5" (127mm)

* Note: Not compatible with 18"x24" units.

Nothing gets in the way of productivity.

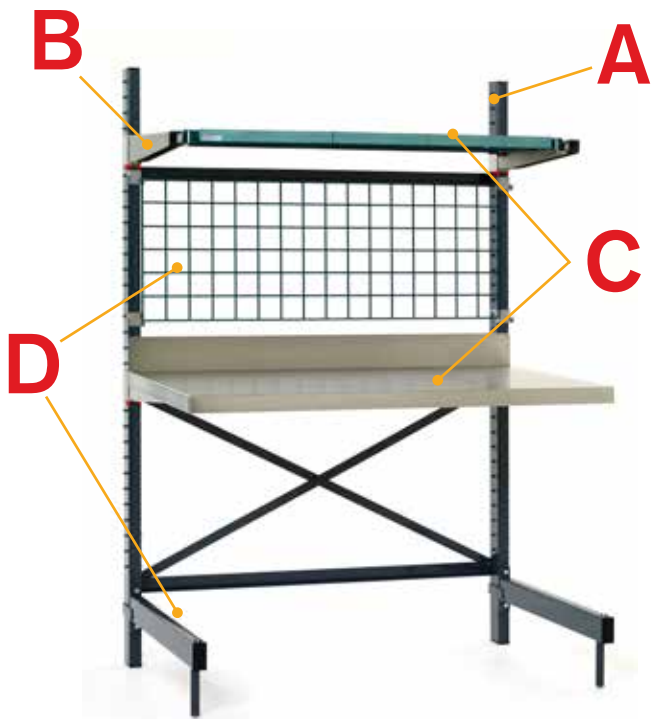

Building SmartLever is as easy as ABCD.

- A:** Select Starter kit
- B:** Select arm pairs to match desired shelf or work surface
- C:** Select compatible shelving or work surface to meet your application needs.
- D:** Add accessories or SmartWall grid to fit application.



SmartLever™ Multifunctional Storage & Workstations — {17.30}

Create the ultimate usable space by combining shelving, stainless worksurface, and smartwall productivity system.

Specifications

- Structure: Heavy gauge cold rolled steel electroplated and epoxy coated with stainless steel hardware.
- Work Surface: 16 gauge, type 304 stainless steel top with Duraplast anti-drumming support.
- Support Arms: 11 gauge stainless steel coated with epoxy.
- Dunnage: heavy gauge steel electroplated and epoxy coated
- Work surface and shelving height adjustable on 2" increments.
- Warranty: 10 year limited warranty against surface rust formation.
- Load Capacity:
 - The total weight load capacity of each model including the bottom shelf, is 2,800 lbs. (1271kg).
 - Each level (work surface or shelf) has a maximum evenly distributed weight load capacity of 600 lbs. (272kg).
 - The maximum uniformly distributed load on the Dunnage rack must not exceed 1,000 lbs. (454kg).



Utilizes Metro Shelving

including but not limited to: Super Erecta, Super Erecta Pro, SmartWall Grid and accessories, and Flat Stainless Shelves.

SMARTLEVER™ PRODUCTIVITY SYSTEM



SmartLever Starter and Add-On Kits — {17.30}

- Starter kit includes, two uprights, two legs, two cross braces, two cross bars
- Add-on kit includes, one upright, one leg, two cross braces and two cross bars

SmartLever Starter Kit	Assembled Unit H x W x L (in.)			Shelving Size L x W (in.)	
SM761824-KIT	22.5	28.25	76.375	18	24
SM761830-KIT	22.5	34.25	76.375	18	30
SM761836-KIT	22.5	40.25	76.375	18	36
SM761842-KIT	22.5	46.25	76.375	18	42
SM761848-KIT	22.5	52.25	76.375	18	48
SM761854-KIT	22.5	58.25	76.375	18	54
SM761860-KIT	22.5	64.25	76.375	18	60
SM761872-KIT	22.5	76.25	76.375	18	72
SM762124-KIT	25.5	28.25	76.375	21	24
SM762130-KIT	25.5	34.25	76.375	21	30
SM762136-KIT	25.5	40.25	76.375	21	36
SM762142-KIT	25.5	46.25	76.375	21	42
SM762148-KIT	25.5	52.25	76.375	21	48
SM762154-KIT	25.5	58.25	76.375	21	54
SM762160-KIT	25.5	64.25	76.375	21	60
SM762172-KIT	25.5	76.25	76.375	21	72
SM762424-KIT	28.5	28.25	76.375	24	24
SM762430-KIT	28.5	34.25	76.375	24	30
SM762436-KIT	28.5	40.25	76.375	24	36
SM762442-KIT	28.5	46.25	76.375	24	42
SM762448-KIT	28.5	52.25	76.375	24	48
SM762454-KIT	28.5	58.25	76.375	24	54
SM762460-KIT	28.5	64.25	76.375	24	60
SM762472-KIT	28.5	76.25	76.375	24	72
SM763024-KIT	34.5	28.25	76.375	30	24
SM763030-KIT	34.5	34.25	76.375	30	30
SM763036-KIT	34.5	40.25	76.375	30	36
SM763042-KIT	34.5	46.25	76.375	30	42
SM763048-KIT	34.5	52.25	76.375	30	48
SM763054-KIT	34.5	58.25	76.375	30	54
SM763060-KIT	34.5	64.25	76.375	30	60
SM763072-KIT	34.5	76.25	76.375	30	72
SM861824-KIT	22.5	28.25	86.375	18	24
SM861830-KIT	22.5	34.25	86.375	18	30
SM861836-KIT	22.5	40.25	86.375	18	36
SM861842-KIT	22.5	46.25	86.375	18	42
SM861848-KIT	22.5	52.25	86.375	18	48
SM861854-KIT	22.5	58.25	86.375	18	54
SM861860-KIT	22.5	64.25	86.375	18	60
SM861872-KIT	22.5	76.25	86.375	18	72
SM862124-KIT	25.5	28.25	86.375	21	24
SM862130-KIT	25.5	34.25	86.375	21	30
SM862136-KIT	25.5	40.25	86.375	21	36
SM862142-KIT	25.5	46.25	86.375	21	42
SM862148-KIT	25.5	52.25	86.375	21	48
SM862154-KIT	25.5	58.25	86.375	21	54
SM862160-KIT	25.5	64.25	86.375	21	60
SM862172-KIT	25.5	76.25	86.375	21	72
SM862424-KIT	28.5	28.25	86.375	24	24
SM862430-KIT	28.5	34.25	86.375	24	30
SM862436-KIT	28.5	40.25	86.375	24	36
SM862442-KIT	28.5	46.25	86.375	24	42
SM862448-KIT	28.5	52.25	86.375	24	48
SM862454-KIT	28.5	58.25	86.375	24	54
SM862460-KIT	28.5	64.25	86.375	24	60
SM862472-KIT	28.5	76.25	86.375	24	72
SM863024-KIT	34.5	28.25	86.375	30	24
SM863030-KIT	34.5	34.25	86.375	30	30
SM863036-KIT	34.5	40.25	86.375	30	36
SM863042-KIT	34.5	46.25	86.375	30	42
SM863048-KIT	34.5	52.25	86.375	30	48
SM863054-KIT	34.5	58.25	86.375	30	54
SM863060-KIT	34.5	64.25	86.375	30	60
SM863072-KIT	34.5	76.25	86.375	30	72

SmartLever Add-On Kit	Assembled Unit H x W x L (in.)			Shelving Size L x W (in.)	
SM761824-ADD	22.5	26.1875	76.375	18	24
SM761830-ADD	22.5	32.1875	76.375	18	30
SM761836-ADD	22.5	38.1875	76.375	18	36
SM761842-ADD	22.5	44.1875	76.375	18	42
SM761848-ADD	22.5	50.1875	76.375	18	48
SM761854-ADD	22.5	56.1875	76.375	18	54
SM761860-ADD	22.5	62.1875	76.375	18	60
SM761872-ADD	22.5	74.1875	76.375	18	72
SM762124-ADD	25.5	26.1875	76.375	21	24
SM762130-ADD	25.5	32.1875	76.375	21	30
SM762136-ADD	25.5	38.1875	76.375	21	36
SM762142-ADD	25.5	44.1875	76.375	21	42
SM762148-ADD	25.5	50.1875	76.375	21	48
SM762154-ADD	25.5	56.1875	76.375	21	54
SM762160-ADD	25.5	62.1875	76.375	21	60
SM762172-ADD	25.5	74.1875	76.375	21	72
SM762424-ADD	28.5	26.1875	76.375	24	24
SM762430-ADD	28.5	32.1875	76.375	24	30
SM762436-ADD	28.5	38.1875	76.375	24	36
SM762442-ADD	28.5	44.1875	76.375	24	42
SM762448-ADD	28.5	50.1875	76.375	24	48
SM762454-ADD	28.5	56.1875	76.375	24	54
SM762460-ADD	28.5	62.1875	76.375	24	60
SM762472-ADD	28.5	74.1875	76.375	24	72
SM763024-ADD	34.5	26.1875	76.375	30	24
SM763030-ADD	34.5	32.1875	76.375	30	30
SM763036-ADD	34.5	38.1875	76.375	30	36
SM763042-ADD	34.5	44.1875	76.375	30	42
SM763048-ADD	34.5	50.1875	76.375	30	48
SM763054-ADD	34.5	56.1875	76.375	30	54
SM763060-ADD	34.5	62.1875	76.375	30	60
SM763072-ADD	34.5	74.1875	76.375	30	72
SM861824-ADD	22.5	26.1875	86.375	18	24
SM861830-ADD	22.5	32.1875	86.375	18	30
SM861836-ADD	22.5	38.1875	86.375	18	36
SM861842-ADD	22.5	44.1875	86.375	18	42
SM861848-ADD	22.5	50.1875	86.375	18	48
SM861854-ADD	22.5	56.1875	86.375	18	54
SM861860-ADD	22.5	62.1875	86.375	18	60
SM861872-ADD	22.5	74.1875	86.375	18	72
SM862124-ADD	25.5	26.1875	86.375	21	24
SM862130-ADD	25.5	32.1875	86.375	21	30
SM862136-ADD	25.5	38.1875	86.375	21	36
SM862142-ADD	25.5	44.1875	86.375	21	42
SM862148-ADD	25.5	50.1875	86.375	21	48
SM862154-ADD	25.5	56.1875	86.375	21	54
SM862160-ADD	25.5	62.1875	86.375	21	60
SM862172-ADD	25.5	74.1875	86.375	21	72
SM862424-ADD	28.5	26.1875	86.375	24	24
SM862430-ADD	28.5	32.1875	86.375	24	30
SM862436-ADD	28.5	38.1875	86.375	24	36
SM862442-ADD	28.5	44.1875	86.375	24	42
SM862448-ADD	28.5	50.1875	86.375	24	48
SM862454-ADD	28.5	56.1875	86.375	24	54
SM862460-ADD	28.5	62.1875	86.375	24	60
SM862472-ADD	28.5	74.1875	86.375	24	72
SM863024-ADD	34.5	26.1875	86.375	30	24
SM863030-ADD	34.5	32.1875	86.375	30	30
SM863036-ADD	34.5	38.1875	86.375	30	36
SM863042-ADD	34.5	44.1875	86.375	30	42
SM863048-ADD	34.5	50.1875	86.375	30	48
SM863054-ADD	34.5	56.1875	86.375	30	54
SM863060-ADD	34.5	62.1875	86.375	30	60
SM863072-ADD	34.5	74.1875	86.375	30	72

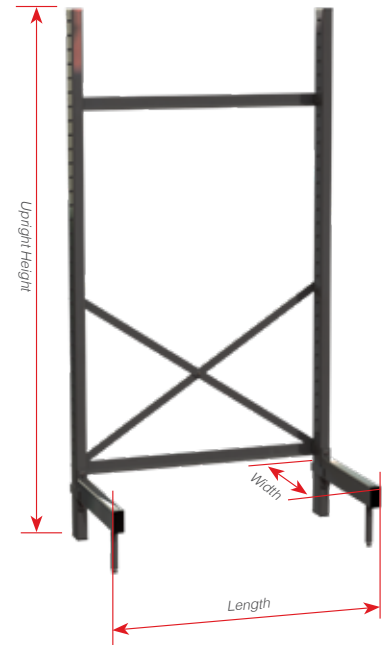

SmartLever Arms

with new ArmKeepers.
Easy to install and a snap to adjust.

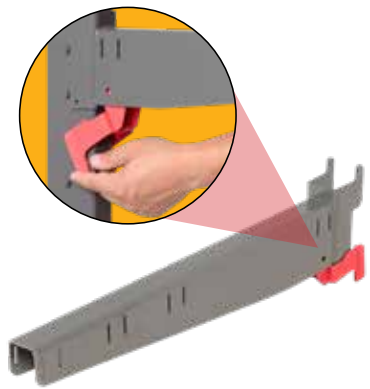

Arms

(Includes (4) shelf mount hooks & (4) locking wedges)

Length	Arms Starter Kit
18	SMA18A
21	SMA21A
24	SMA24A
30	SMA30A

Length	Arm Add-On
18	SMA18A-ADD
21	SMA21A-ADD
24	SMA24A-ADD
30	SMA30A-ADD

Compatible Shelves

Shelving Size L x W (in.)	Super Erecta Pro	Super Erecta Solid Stainless	Super Erecta Metroseal 3	Super Erecta Super Brite	Super Erecta Chrome	Super Erecta Stainless	Super Erecta Metroseal 3 Dunnage
14 24	-	1424FS	1424NK3	1424BR	1424NC	1424NS	-
14 30	-	1430FS	1430NK3	1430BR	1430NC	1430NS	-
14 36	-	1436FS	1436NK3	1436BR	1436NC	1436NS	-
14 42	-	1442FS	1442NK3	1442BR	1442NC	1442NS	-
14 48	-	1448FS	1448NK3	1448BR	1448NC	1448NS	-
14 54	-	-	1454NK3	1454BR	1454NC	1454NS	-
14 60	-	1460FS	1460NK3	1460BR	1460NC	1460NS	-
14 72	-	-	1472NK3	1472BR	1472NC	1472NS	-
18 24	PR1824NK3	1824FS	1824NK3	1824BR	1824NC	1824NS	1824DRK3
18 30	PR1830NK3	1830FS	1830NK3	1830BR	1830NC	1830NS	1830DRK3
18 36	PR1836NK3	1836FS	1836NK3	1836BR	1836NC	1836NS	1836DRK3
18 42	PR1842NK3	1842FS	1842NK3	1842BR	1842NC	1842NS	1842DRK3
18 48	PR1848NK3	1848FS	1848NK3	1848BR	1848NC	1848NS	1848DRK3
18 54	PR1854NK3	-	1854NK3	1854BR	1854NC	1854NS	1854DRK3
18 60	PR1860NK3	1860FS	1860NK3	1860BR	1860NC	1860NS	1860DRK3
18 72	PR1872NK3	1872FS	1872NK3	1872BR	1872NC	1872NS	-
21 24	PR2124NK3	2124FS	2124NK3	2124BR	2124NC	2124NS	2124DRK3
21 30	PR2130NK3	2130FS	2130NK3	2130BR	2130NC	2130NS	2130DRK3
21 36	PR2136NK3	2136FS	2136NK3	2136BR	2136NC	2136NS	2136DRK3
21 42	PR2142NK3	2142FS	2142NK3	2142BR	2142NC	2142NS	2142DRK3
21 48	PR2148NK3	2148FS	2148NK3	2148BR	2148NC	2148NS	2148DRK3
21 54	PR2154NK3	-	2154NK3	2154BR	2154NC	2154NS	2154DRK3
21 60	PR2160NK3	2160FS	2160NK3	2160BR	2160NC	2160NS	2160DRK3
21 72	PR2172NK3	-	2172NK3	2172BR	2172NC	2172NS	-
24 24	PR2424NK3	2424FS	2424NK3	2424BR	2424NC	2424NS	2424DRK3
24 30	PR2430NK3	2430FS	2430NK3	2430BR	2430NC	2430NS	2430DRK3
24 36	PR2436NK3	2436FS	2436NK3	2436BR	2436NC	2436NS	2436DRK3
24 42	PR2442NK3	2442FS	2442NK3	2442BR	2442NC	2442NS	2442DRK3
24 48	PR2448NK3	2448FS	2448NK3	2448BR	2448NC	2448NS	2448DRK3
24 54	PR2454NK3	-	2454NK3	2454BR	2454NC	2454NS	2454DRK3
24 60	PR2460NK3	2460FS	2460NK3	2460BR	2460NC	2460NS	2460DRK3
24 72	PR2472NK3	2472FS	2472NK3	2472BR	2472NC	2472NS	-
30 36	-	-	3036NK3	-	3036NC	3036NS	-
30 42	-	-	3042NK3	-	3042NC	-	-
30 48	-	-	3048NK3	-	3048NC	3048NS	-
30 54	-	-	3054NK3	-	3054NC	-	-
30 60	-	-	3060NK3	-	3060NC	3060NS	-
30 72	-	-	3072NK3	-	3072NC	3072NS	-

*Arm size must match shelf depth. For example, 2148NK3 shelf will use SMA 21A.



Replacement Endcap
Bag of 2
Cat. No. RPC06-1211

Replacement Locking Wedge
Bag of 4
Cat. No. RPSMLW

Replacement Hole Plugs
Bag of 10
Cat. No. RPSMHP



Replacement Shelf Mount Hook
Bag of 4
Cat. No. SMS

Replacement Hardware Bag Cross Bar & Cross Brace
Cat. No. RPHDWE-SMB

Replacement Bag for Arms
Cat. No. RPARAM-HDWEBAG

Worksurfaces

Cat. No.	Description	Approx. Pkd. Wt. (lbs.)	Approx. Pkd. Wt. (kg)
SMW36	SmartLever 30x36 SS Work Surface	33.6	15.3
SMW42	SmartLever 30x42 SS Work Surface	38.3	17.5
SMW48	SmartLever 30x48 SS Work Surface	42.9	19.5
SMW54	SmartLever 30x54 SS Work Surface	47.6	21.3
SMW60	SmartLever 30x60 SS Work Surface	52.2	23.8
SMW72	SmartLever 30x72 SS Work Surface	61.4	28

*Work surfaces need Shelf and Arms, which must be ordered separately.

Accessory Grids

Grids	Plated	MetroSeal 3
18x36	WG1836BR	WG1836K3
18x42	-	WG1842K3
18x48	WG1848BR	WG1848K3
18x54	-	WG1854K3
18x60	WG1860BR	WG1860K3
18x72	-	WG1872K3

Note: See page 87 for grid accessories.

Grid Bracket

Cat. No.	Description
SMR*	SmartLever Grid Bracket (4 pack)

*must be purchased if ordering a grid.

Leg Hooks

Cat. No.	Description
LSH1	Single Leg Hook (4 Pack)
LSH2	Double Leg Hook (2 Pack)

Note: LSH1 and LSH2 hooks are used to allow a standard SES shelf instead of the dunnage shelf. This reduces the load capacity



1. Arm size must match shelf depth. For example 2148NK3 shelf will use SMA21A or SMA21A-ADD.
2. Arms/Shelves must be less than or equal to the length of the leg.
3. Shared arms need to be at the same level.
4. Work surfaces need Shelf and arms, which must be ordered separately. For example a SMW36 requires One (1) SMA30 and (1) 30x36 wire shelf (3036BR or 3036NK3)
5. SMR (4 wall grid hooks) must be ordered along with a wall grid. They are required for mounting the wall grid to SmartLever unit. Refer Spec Sheets 10.42 & 10.43 for SmartWall system.

Be smarter with your space.



Metro Breakfast Cart

- Includes eye catching two-sided sign
- Type 304 stainless steel top for easy cleaning
- Bonus wire center shelf adjusts at 1" increments to accommodate your changing breakfast offerings
- Comes with four 5" swivel stem casters all with brakes for easy rolling and secure positioning



Comes with a two-sided sign.

Description	Height		Approx. Pkd. Wt.		Cat. No.
	(in.)	(mm)	(lb.)	(kg)	
24x36 Stainless steel top with adjustable middle shelf	70	1178	67.9	25.3	GG2436
24x48 Stainless steel top with adjustable middle shelf	70	1178	83.1	31	GG2448
24x60 Stainless steel top with adjustable middle shelf	70	1178	94	35	GG2460

Note: Comes with 2-sided sign.

Why is it smart to pick a SmartStation?

- Fully modular components & accessories
- Value-bundled for simplicity
- Pre-optimized for space savings and workflow efficiency.

Super Erecta® Prep Station

- Perfect for multi-functional spaces.
- Access items easy with the SmartWall system.
- Unit Includes 18" x48" (457x1219mm) SmartWall Grid, (1) Hanger Rails, Accessory Pack, 14"x48" (356x1219mm) Upper Shelf, 14"x48" (356x1219mm) Stainless Steel Intermediate Shelf, 24"x48" (102x1219mm) Stainless Worksurface, 24"x48" (102x1219mm) Lower Shelf, 3-Sided Snake Frame, (2) 27" (686mm) Upper Posts, (2) 33" (838mm) Lower posts, (2) 63" (1600mm) High Back Posts



Description	Approx. Pkd. Wt.		Cat. No.
	(lb)	(kg)	
24x48 Super Erecta Prep Station	86.5	39.2	SMSP2448NK3

SmartWall® & Super Erecta® Prep Station with Undercounter Mobile Prep Cart

- Easy-mount wall track makes set-up a snap.
- Access items easy with the SmartWall system.
- Wall unit holds up to 250 lbs. (113kg)
- Wall Unit Includes: 40" Wall Track, (2) Shelf Supports, 18" x36" (457x915mm) Wire Shelf, (2) Hanger Rails, 18"x36" (457x915mm) Accessory Grid, Accessory Pack
- Base Unit Includes: 24"x36" (102x914) Stainless Steel Worksurface, (1) 3-Sided Frames, (4) 25" (584mm) Mobile Posts, (4) 33" (838mm) Base Unit Posts, (2) 18"x30" (457x762mm) Wire Shelves, 18"x30" (457x762mm) Stainless Steel Worksurface, (4) Casters (2-swivel/2 Brake)



Description	Approx. Pkd. Wt.		Cat. No.
	(lb)	(kg)	
24x36 SmartWall Prep Station w/ Undercounter Utility	116.7	52.9	SMSPM2436

Easy to Assemble.

Units can be put together in minutes without the use of special tools. Bottom shelf or frame is adjustable in 1" increments.

Strong & Robust.

NEW
SPACE SAVER
WORKTABLES **24"**
DEEP



Space Saver Worktables — {17.40}

Sturdy construction provides a robust 800 lb. load rating. Mobile tables are rated to 600 lbs. Type 304 Stainless Steel components. 1" (25mm) diameter posts and patented Super Erecta Shelf construction. Heavy-duty 14-gauge stainless steel virtually eliminates "drumming."

Preconfigured units are offered both in stationary with a leveling foot and mobile utilizing a 5" polymer corrosion resistant caster. Worktables can also be customized using Super Erecta® components in any finish to fit your application.



Stationary Space Saver Worktables

24" Deep (610mm)



Description	Length		Approx. Pkd. Wt.		Cat. No.
	(in.)	(mm)	(lb.)	(kg)	
24x36 SS Worktable, Stationary with Solid Shelf	36	914	64	29	WTS2436FS
24x48 SS Worktable, Stationary with Solid Shelf	48	1219	81	37	WTS2448FS
24x60 SS Worktable, Stationary with Solid Shelf	60	1524	93	42	WTS2460FS
24x36 SS Worktable, Stationary with 3-Sided Frame	36	914	53	24	WTS2436US
24x48 SS Worktable, Stationary with 3-Sided Frame	48	1219	65	29	WTS2448US
24x60 SS Worktable, Stationary with 3-Sided Frame	60	1524	75	34	WTS2460US

Mobile Space Saver Worktables

24" Deep (610mm)



Description	Length		Approx. Pkd. Wt.		Cat. No.
	(in.)	(mm)	(lb.)	(kg)	
24x36 SS Worktable, Mobile with Solid Shelf	36	914	64	29	MWTS2436FS
24x48 SS Worktable, Mobile with Solid Shelf	48	1219	82	37	MWTS2448FS
24x60 SS Worktable, Mobile with Solid Shelf	60	1524	94	43	MWTS2460FS
24x36 SS Worktable, Mobile with 3-Sided Frame	36	914	53	25	MWTS2436US
24x48 SS Worktable, Mobile with 3-Sided Frame	48	1219	66	30	MWTS2448US
24x60 SS Worktable, Mobile with 3-Sided Frame	60	1524	76	35	MWTS2460US

Stainless Worktables — {52.03}

- Corrosion-proof performance — stainless steel construction throughout.
- Easily cleaned smooth surfaces. Mobile units can be easily moved to clean behind table area.
- Available top materials include Type 304 stainless and TRESPA Phenolic resin (black or gray). Refer to chart below for more information.
- Choose from a wide range of accessories and caster options (pages 100-101) to customize table.

Countertop Application Matrix			Characteristics	Phenolic Resin	Stainless Steel
Use Area	Phenolic Resin	Stainless Steel			
			Heat Resistance	Fair*	Excellent
Low chemical use			Abrasion Resistance	Excellent	Good
Moderate chemical use	X		Impact Resistance	Excellent	Good
High chemical use	X	X	Strength	Excellent	Good
			Stain Resistance	Good	Good

*Discolors with high heat
Note: Phenolic resin and stainless are offered as top options for this table system.

Definitions:

Phenolic resin: Compression molded of organic fiber-reinforced phenolic core with an integrally cured thermoset resin surface. Stronger than Epoxy resin over a span, and not as brittle.

Stainless Steel: Worksurfaces are fabricated from Type 304 stainless steel which provides excellent protection in corrosive environments.

Epoxy resin: Epoxy resins, silica, organic fillers, and inert hardeners are cast in forms and cured to a uniform mixture throughout.

Tables with Stainless Island Top and Solid HD Shelf (Casters sold separately)

Width (in.)	Length (mm)	Length (in.)	Width (mm)	Work Surface Height		Approx. Pkd. Wt. (lbs.) (kg)	Cat. No. Stationary	Cat. No. Mobile*	
				Stationary (in.)	Mobile (mm)				
30.000	762	29.750	755	35.375	898	35.188 893	65 30	LTS30IS	LTSM30IS
30.000	762	35.750	908	35.375	898	35.188 893	80 36	LTS36IS	LTSM36IS
30.000	762	47.750	1212	35.375	898	35.188 893	103 47	LTS48IS	LTSM48IS
30.000	762	59.750	1517	35.375	898	35.188 893	140 63	LTS60IS	LTSM60IS

Leveling feet on stationary units have 1.250 (31mm) vertical adjustment.
*Casters ordered separately. Refer to Caster Selection Guide (page 195) for more information.
Stainless Tables are load rated at 50 lbs. per sq. foot (.024kg per sq. cm) up to a maximum of 600 lbs. (273kg) assuming evenly distributed load and caster specification meets requirement.
Note: Mobile posts include an adaptor insert that will accept Metro 5" (127mm) stem casters.

Tables with Stainless Island Top and 3-Sided Frame (Casters sold separately)

Width (in.)	Length (mm)	Length (in.)	Width (mm)	Work Surface Height		Approx. Pkd. Wt. (lbs.) (kg)	Cat. No. Stationary	Cat. No. Mobile*	
				Stationary (in.)	Mobile (mm)				
30.000	762	29.750	755	35.375	898	35.188 893	58 26	LTS30UIS	LTSM30UIS
30.000	762	35.750	908	35.375	898	35.188 893	70 32	LTS36UIS	LTSM36UIS
30.000	762	47.750	1212	35.375	898	35.188 893	91 41	LTS48UIS	LTSM48UIS
30.000	762	59.750	1517	35.375	898	35.188 893	119 54	LTS60UIS	LTSM60UIS

Leveling feet on stationary units have 1.250 (31mm) vertical adjustment.
*Casters ordered separately. Refer to Caster Selection Guide (page 195) for more information.
Stainless Tables are load rated at 50 lbs. per sq. foot (.024kg per sq. cm) up to a maximum of 600 lbs. (273kg) assuming evenly distributed load and caster specification meets requirement.
Note: Mobile posts include an adaptor insert that will accept Metro 5" (127mm) stem casters.

Tables with Stainless Backsplash Top and Solid HD Shelf (Casters sold separately)

Width (in.)	Length (mm)	Length (in.)	Width (mm)	Work Surface Height		Approx. Pkd. Wt. (lbs.) (kg)	Cat. No. Stationary	Cat. No. Mobile*	
				Stationary (in.)	Mobile (mm)				
30.000	762	29.750	755	35.375	898	35.188 893	65 30	LTS30S	LTSM30S
30.000	762	35.750	908	35.375	898	35.188 893	80 36	LTS36S	LTSM36S
30.000	762	47.750	1212	35.375	898	35.188 893	103 47	LTS48S	LTSM48S
30.000	762	59.750	1517	35.375	898	35.188 893	140 63	LTS60S	LTSM60S

Leveling feet on stationary units have 1.250 (31mm) vertical adjustment.
*Casters ordered separately. Refer to Caster Selection Guide (page 195) for more information.
Stainless Tables are load rated at 50 lbs. per sq. foot (.024kg per sq. cm) up to a maximum of 600 lbs. (273kg) assuming evenly distributed load and caster specification meets requirement.
Note: Mobile posts include an adaptor insert that will accept Metro 5" (127mm) stem casters.

Tables with Stainless Backsplash Top and 3-Sided Frame (Casters sold separately)

Width (in.)	Length (mm)	Length (in.)	Width (mm)	Work Surface Height		Approx. Pkd. Wt. (lbs.) (kg)	Cat. No. Stationary	Cat. No. Mobile*	
				Stationary (in.)	Mobile (mm)				
30.000	762	29.750	755	35.375	898	35.188 893	58 26	LTS30US	LTSM30US
30.000	762	35.750	908	35.375	898	35.188 893	70 32	LTS36US	LTSM36US
30.000	762	47.750	1212	35.375	898	35.188 893	91 41	LTS48US	LTSM48US
30.000	762	59.750	1517	35.375	898	35.188 893	119 54	LTS60US	LTSM60US

Leveling feet on stationary units have 1.250 (31mm) vertical adjustment.
*Casters ordered separately. Refer to Caster Selection Guide (page 195) for more information.
Stainless Tables are load rated at 50 lbs. per sq. foot (.024kg per sq. cm) up to a maximum of 600 lbs. (273kg) assuming evenly distributed load and caster specification meets requirement.
Note: Mobile posts include an adaptor insert that will accept Metro 5" (127mm) stem casters.



LTSM30IS with casters
(ordered separately)



LTSM60UIS with optional
accessories and casters



LTS30US with optional
accessory wire shelf

Stainless Worktables — {52.03}

Tables with Black Phenolic Top and Solid HD Shelf
(Casters and backplash accessory ordered separately) Utilizes Heavy Duty 1³/₈" (41mm) Posts



LTSM30PB

Width (in.)	Length (mm)	Length (in.)	Stationary (in.)	Work Surface Height		Approx. Pkd. Wt. (lbs.) (kg)	Cat. No. Stationary	Cat. No. Mobile*		
				Stationary (mm)	Mobile (mm)					
30.000	762	29.750	755	36.000	914	35.875	911	77 35	LTS30PB	LTSM30PB
30.000	762	35.750	908	36.000	914	35.875	911	92 41	LTS36PB	LTSM36PB
30.000	762	47.750	1212	36.000	914	35.875	911	113 51	LTS48PB	LTSM48PB
30.000	762	59.750	1517	36.000	914	35.875	911	141 64	LTS60PB	LTSM60PB

Leveling feet on stationary units have 1.250 (31mm) vertical adjustment.

*Casters ordered separately. Refer to Caster Selection Guide (below) for more information.

Stainless Tables are load rated at 50 lbs. per sq. foot (.024kg per sq. cm) up to a maximum of 600 lbs. (273kg) assuming evenly distributed load and caster specification meets requirement.

Note: Mobile posts include an adaptor insert that will accept Metro 5" (127mm) stem casters.



LTSM60UPB with accessories, casters, backplash, and Starsys™ cart

Stainless Tables with Black Phenolic Top and 3-Sided Frame
(Casters and backplash accessory ordered separately) Utilizes Heavy Duty 1³/₈" (41mm) Posts

Width (in.)	Length (mm)	Length (in.)	Stationary (in.)	Work Surface Height		Approx. Pkd. Wt. (lbs.) (kg)	Cat. No. Stationary	Cat. No. Mobile*		
				Stationary (mm)	Mobile (mm)					
30.000	762	29.750	755	36.000	914	35.875	911	70 32	LTS30UPB	LTSM30UPB
30.000	762	35.750	908	36.000	914	35.875	911	82 37	LTS36UPB	LTSM36UPB
30.000	762	47.750	1212	36.000	914	35.875	911	101 46	LTS48UPB	LTSM48UPB
30.000	762	59.750	1517	36.000	914	35.875	911	120 54	LTS60UPB	LTSM60UPB

Leveling feet on stationary units have 1.250 (31mm) vertical adjustment.

*Casters ordered separately. Refer to Caster Selection Guide (below) for more information.

Stainless Tables are load rated at 50 lbs. per sq. foot (.024kg per sq. cm) up to a maximum of 600 lbs. (273kg) assuming evenly distributed load and caster specification meets requirement.

Note: Mobile posts include an adaptor insert that will accept Metro 5" (127mm) stem casters.



LTSM30PG

Stainless Tables with Gray Phenolic Top and Solid HD Shelf
(Casters and backplash accessory ordered separately) Utilizes Heavy Duty 1³/₈" (41mm) Posts

Width (in.)	Length (mm)	Length (in.)	Stationary (in.)	Work Surface Height		Approx. Pkd. Wt. (lbs.) (kg)	Cat. No. Stationary	Cat. No. Mobile*		
				Stationary (mm)	Mobile (mm)					
30.000	762	29.750	755	36.000	914	35.875	911	77 35	LTS30PG	LTSM30PG
30.000	762	35.750	908	36.000	914	35.875	911	92 41	LTS36PG	LTSM36PG
30.000	762	47.750	1212	36.000	914	35.875	911	113 51	LTS48PG	LTSM48PG
30.000	762	59.750	1517	36.000	914	35.875	911	141 64	LTS60PG	LTSM60PG

Leveling feet on stationary units have 1.250 (31mm) vertical adjustment.

*Casters ordered separately. Refer to Caster Selection Guide (below) for more information.

Stainless Tables are load rated at 50 lbs. per sq. foot (.024kg per sq. cm) up to a maximum of 600 lbs. (273kg) assuming evenly distributed load and caster specification meets requirement.

Note: Mobile posts include an adaptor insert that will accept Metro 5" (127mm) stem casters.



LTSM60UPG with accessories, casters, backplash, and Starsys™ cart

Stainless Tables with Gray Phenolic Top and 3-Sided Frame
(Casters and backplash accessory ordered separately) Utilizes Heavy Duty 1³/₈" (41mm) Posts

Width (in.)	Length (mm)	Length (in.)	Stationary (in.)	Work Surface Height		Approx. Pkd. Wt. (lbs.) (kg)	Cat. No. Stationary	Cat. No. Mobile*		
				Stationary (mm)	Mobile (mm)					
30.000	762	29.750	755	36.000	914	35.875	911	70 32	LTS30UPG	LTSM30UPG
30.000	762	35.750	908	36.000	914	35.875	911	82 37	LTS36UPG	LTSM36UPG
30.000	762	47.750	1212	36.000	914	35.875	911	101 46	LTS48UPG	LTSM48UPG
30.000	762	59.750	1517	36.000	914	35.875	911	120 54	LTS60UPG	LTSM60UPG

Leveling feet on stationary units have 1.250 (31mm) vertical adjustment.

*Casters ordered separately. Refer to Caster Selection Guide (below) for more information.

Stainless Tables are load rated at 50 lbs. per sq. foot (.024kg per sq. cm) up to a maximum of 600 lbs. (273kg) assuming evenly distributed load and caster specification meets requirement.

Note: Mobile posts include an adaptor insert that will accept Metro 5" (127mm) stem casters.

For Stainless Steel Mobile Worktables, Select Appropriate Casters from Chart Below.

(Four brake casters are recommended for maximum table stability)

Caster Selection Guide

Caster Series	Wheel Material	Rollability	Floor Protection	Noise	Load Rating (lbs.) (kg)	Corrosion Resistance	Cart Washable	Antimicrobial Additive in Wheel
5MDA/5MDBA (brake)	High Modulus Rubber	Good	Good	Low	250 114	Low	No	No
5MP/5MPB (brake)	Polyurethane	Good	Good	Moderate	300 137	Low	No	No
5PC/5PCB (brake)	Polyurethane	Good	Good	Moderate	300 137	High	No	No
5PCM/5PCBM (brake)	Polyurethane	Good	Good	Moderate	300 137	High	No	Yes
5MPGSA/5MPBGSA (brake)	Polyurethane	Good	Good	Moderate	300 137	High	Yes	No

NOTE: The total weight of the equipment and its load should not exceed three times the load rating per caster. Additional stem casters, in various sizes and wheel materials, are available. Contact your Metro rep for more information.



5MDA



5MP



5PCB



5PCBM



5MPGSA

Stainless Worktable Accessories — {52.03}

Backsplash

4" (102mm) high. Attaches to phenolic table top using pre-drilled holes. Match length and color with selected countertop.

Length (in.) (mm)		Approx. Pkd. Wt. (lbs.) (kg)		Cat. No. Black	Cat. No. Gray
27 ³ / ₄	705	5.5	2.5	LT30BSB	LT30BSG
33 ³ / ₄	875	6.5	2.9	LT36BSB	LT36BSG
45 ³ / ₄	1162	7.5	3.4	LT48BSB	LT48BSG
57 ³ / ₄	1466	9.5	4.3	LT60BSB	LT60BSG



LT30BSG

Wire Shelf

Stainless or Epoxy-coated shelves available.

Length (in.) (mm)		Approx. Pkd. Wt. (lbs.) (kg)		Cat. No. Stainless
22 ³ / ₈	568	6	2.7	LT30WS
28 ³ / ₈	720	7.5	3.4	LT36WS
40 ³ / ₈	1025	10	4.5	LT48WS
52 ³ / ₈	1330	12	5.4	LT60WS

Note: Shelves are load rated for a maximum of 150 lbs. (68kg).



LT30WS

Stainless Keyboard Tray

Fits 48" and 60" (1219 and 1524mm) table lengths

Cat. No. **LTSKB**

Note: Stainless keyboard tray and stainless drawer will both fit 60" (1524mm) long table.



LTSKB

Stainless Drawer

Fits 30", 36", 48" and 60" (760, 914, 1219 and 1524mm) table lengths

Drawer, when fully extended, provides a 7⁵/₈" (194mm) opening.

Cat. No. **LTSD6**

Note: Stainless keyboard tray and stainless drawer will both fit 60" (1524mm) long table.



LTSD6

Surface Mount Swing Arm for Flat Monitor

Cat. No. **LTfMA**

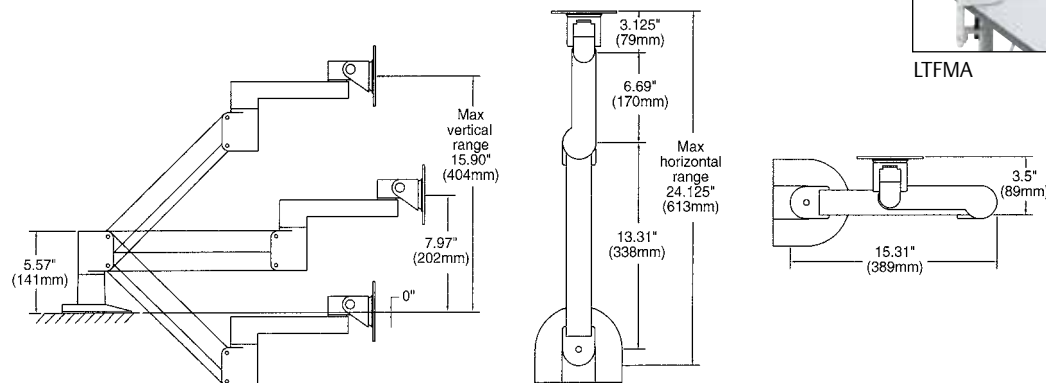

LTfMA

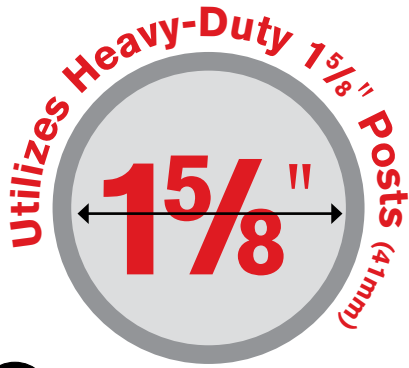

Worktable with Bottom Shelf

Worktables — {17.20}

Built for cleanliness and stability.

- Seamless 14-gauge Type 304 stainless steel work surface and support structure.
- Shipped knocked down and can be assembled in minutes without tools.

All Worktables are 34" (864mm) high with stationary posts and leveling feet.

Standard Worktables — 30" (760mm) Wide

Length (in.) (mm)	Post Material	Bottom Shelf Material	Bottom 3-Sided Frame Material	Bottom H-Frame Material	Approx. Pkd. Wt. (lbs.) (kg)	Cat. No.
48 1219	SS	SS	—	—	90 41	WT305FS
60 1524	SS	SS	—	—	130 59	WT306FS
72 1825	SS	SS	—	—	170 77	WT307FS
96 2439	SS	SS	—	—	226 103	WT309FS
60 1524	Chrome	Galvanized	—	—	146 66	WT306FC
72 1825	Chrome	Galvanized	—	—	180 82	WT307FC
96 2439	Chrome	Galvanized	—	—	226 103	WT309FC
48 1219	SS	—	SS	—	115 52	WT305US
60 1524	SS	—	SS	—	115 52	WT306US
72 1825	SS	—	SS	—	142 65	WT307US
96 2439	SS	—	SS	—	201 91	WT309US
60 1524	SS	—	—	SS	115 52	WT306HS
72 1825	SS	—	—	SS	142 65	WT307HS
96 2439	SS	—	—	SS	202 92	WT309HS

SS = Stainless Steel

Standard Worktables — 36" (914mm) Wide



Length (in.) (mm)	Post Material	Bottom Shelf Material	Bottom 3-Sided Frame Material	Bottom H-Frame Material	Approx. Pkd. Wt. (lbs.) (kg)	Cat. No.
60 1524	SS	SS	—	—	125 57	WT366FS
72 1825	SS	SS	—	—	130 59	WT367FS
96 2439	SS	SS	—	—	185 84	WT369FS
60 1524	Chrome	Galvanized	—	—	125 57	WT366FC
72 1825	Chrome	Galvanized	—	—	130 59	WT367FC
96 2439	Chrome	Galvanized	—	—	185 84	WT369FC
60 1524	SS	—	SS	—	104 47	WT366US
72 1825	SS	—	SS	—	106 48	WT367US
96 2439	SS	—	SS	—	161 73	WT369US
60 1524	SS	—	—	SS	103 47	WT366HS
72 1825	SS	—	—	SS	107 49	WT367HS
96 2439	SS	—	—	SS	162 74	WT369HS

SS = Stainless Steel

Standard Worktables — 44" (1118mm) Wide



Length (in.) (mm)	Post Material	Bottom Shelf Material	Bottom 3-Sided Frame Material	Bottom H-Frame Material	Approx. Pkd. Wt. (lbs.) (kg)	Cat. No.
60 1524	SS	SS	—	—	136 62	WT446FS
72 1825	SS	SS	—	—	160 73	WT447FS
96 2439	SS	SS	—	—	202 92	WT449FS
60 1524	Chrome	Galvanized	—	—	136 62	WT446FC
72 1825	Chrome	Galvanized	—	—	160 73	WT447FC
96 2439	Chrome	Galvanized	—	—	202 92	WT449FC
60 1524	SS	—	SS	—	114 52	WT446US
72 1825	SS	—	SS	—	135 61	WT447US
96 2439	SS	—	SS	—	177 81	WT449US
60 1524	SS	—	—	SS	113 51	WT446HS
72 1825	SS	—	—	SS	136 62	WT447HS
96 2439	SS	—	—	SS	178 81	WT449HS

SS = Stainless Steel



Worktable with H-Frame

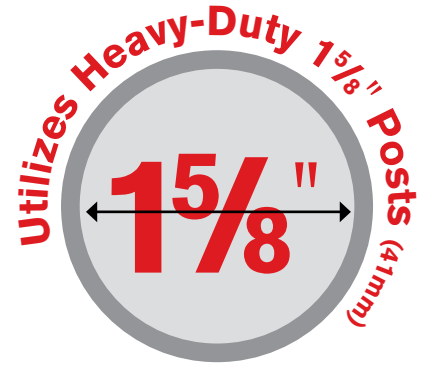

Mobile Worktables — {17.20}

All Mobile Worktables are 34" (864mm) high. Mobile units have special posts and four 5" (127mm) poly casters — 2 swivel/2 brake.

Mobile Worktables — 30" (760mm) Wide

Length (in.) (mm)	Post Material	Bottom Shelf Material	Bottom 3-Sided Frame Material	Bottom H-Frame Material	Approx. Pkd. Wt. (lbs.) (kg)	Cat. No.
48 1219	SS	SS	—	—	105 48	MWT305FS
60 1524	SS	SS	—	—	160 73	MWT306FS
72 1825	SS	SS	—	—	182 83	MWT307FS
96 2439	SS	SS	—	—	226 103	MWT309FS
60 1524	Chrome	Galvanized	—	—	146 66	MWT306FC
72 1825	Chrome	Galvanized	—	—	180 82	MWT307FC
96 2439	Chrome	Galvanized	—	—	226 103	MWT309FC
48 1219	SS	—	SS	—	130 59	MWT305US
60 1524	SS	—	SS	—	139 63	MWT306US
72 1825	SS	—	SS	—	155 71	MWT307US
96 2439	SS	—	SS	—	201 91	MWT309US
60 1524	SS	—	—	SS	124 56	MWT306HS
72 1825	SS	—	—	SS	156 71	MWT307HS
96 2439	SS	—	—	SS	202 92	MWT309HS



Mobile Worktable

Worktables with Overhead — {17.26}

All Worktables with Overhead are 30" (760mm) wide and have rear posts that are approximately 88" (2235mm) high. Cantilever shelves for overhead models are sold separately.

Length (in.) (mm)	Post Material	Bottom Shelf Material	Bottom 3-Sided Frame Material	Approx. Pkd. Wt. (lbs.) (kg)	Cat. No.
60 1524	SS	SS	—	158 71	WTC306FS
72 1825	SS	SS	—	251 114	WTC307FS
96 2440	SS	SS	—	288 131	WTC309FS
60 1524	Chrome	Galvanized	—	214 97	WTC306FC
72 1825	Chrome	Galvanized	—	251 114	WTC307FC
96 2440	Chrome	Galvanized	—	288 131	WTC309FC
60 1524	SS	—	SS	196 89	WTC306US
72 1825	SS	—	SS	230 105	WTC307US
96 2440	SS	—	SS	267 121	WTC309US

All overhead models are fitted with stationary posts and leveling feet.
For overhead models in other sizes, contact your InterMetro representative.
SS = Stainless Steel



Shown with optional Cantilever Shelf and Utility Rack



Cantilever Shelf

Cantilever Shelf — {10.67}

Width/Length (in.) (mm)		Fits Unit	Approx. Pkd. Wt. (lbs.) (kg)		Cat. No. Chrome	Cat. No. Stainless
12x54	304x1372	60" (1524mm) long	11.8	5.3	1254CHC	1254CHS
12x60	304x1524	72" (1830mm) long & 96" (2440mm) long	12.7	5.7	1260CHC	1260CHS

HD Super® Replacement Parts — {10.69}

3 1/2" (89mm) Foot Plates
Cat. No. 9993HS

Post Clamps
Cat. No. 9994HZ

Replacement HD Super® Plastic Split Sleeves
4 pair per bag
Cat. No. 9985H

Replacement HD Super® Aluminum Split Sleeves with Zinc Ring
4 pair per bag
Cat. No. 9986HZ

Wall Mounting Brackets
(not shown)
Cat. No. 9984HZ

Replacement 5 1/2" (140mm) Donut Bumpers
Cat. No. 9992H
Above fit 1 5/8" (41mm) posts only.



3 1/2" (89mm) Foot Plate



Replacement HD Super® Plastic Split Sleeve



Replacement 5 1/2" (140mm) Donut Bumper



Post Clamp



Replacement HD Super® Aluminum Split Sleeve

Accessories for Worktables with Overhead — {17.26}

Utility Racks for Overhead Models

Inside dimensions measure 1 15/16" (48mm) high and 4 3/8" (109mm) wide.

Inside Length (in.) (mm)		Fits Units (in.)	Finish	Approx. Pkd. Wt. (lbs.) (kg)		Cat. No.
51 9/16	1406	60 long	Chrome-Plated	7.7	3.5	654SRC
57 9/16	1406	72 long & 96 long	Chrome-Plated	8.3	3.8	660SRC



Utility Rack

Utility Hook for Cantilever Shelves

Width/Height/Depth (in.) (mm)		Finish	Approx. Pkd. Wt. (lbs.) (kg)		Cat. No.
3 7/8x3 7/16x1 11/16	9x87x43	Chrome	0.1	.045	HK23C
3 7/8x3 7/16x1 11/16	9x87x43	Stainless	0.1	.045	HK23S



Utility Hook

Accessories for All Worktables

Economy Drawer

Overall Dimensions Width/Length/Height (in.) (mm)		Dimensions Inside Bottom (in.) (mm)		Approx. Pkd. Wt. (lbs.) (kg)		Cat. No.
14 1/4x28x5 3/4	362x711x146	10x16	254x406	6.8	3.1	WTD21C



Deluxe Drawer

Deluxe Drawer

Table accepts up to two drawers stacked.

Overall Dimensions Width/Length/Height (in.) (mm)		Dimensions Inside Bottom (in.) (mm)		Approx. Pkd. Wt. (lbs.) (kg)		Cat. No.
24x25 3/4x7 1/2	610x654x191	20x20	508x508	31	13.9	WTD51S

Let's Chat.



www.metro.com

Customer Service
1.800.992.1776



**Take
advantage
of every
square inch.**



qwikTrack®
Top-Track®

HIGH-DENSITY STORAGE & SEISMIC SHELVING

High-Density Movable Aisle Shelving	108-111
Vertical High-Density Shelving	112-116
Seismic Shelving	117-121

So smart...

qwikTRAK® High-Density Storage



BOOST
STORAGE SPACE
BY UP TO
50%
WITH NO ADDED
CONSTRUCTION
COSTS.

qwikTRAK key facts

The aluminum and stainless steel floor tracks provide a smooth, gliding surface for mobile units.

- Mobile units are designed to move easily and store heavy weight loads. MetroMax i mobile qwikTRAK units can hold up to 1,200 lbs. (544kg). MetroMax Q, Super Adjustable, and Super Erecta mobile qwikTRAK units can hold up to 2,000 lbs. (907kg). MetroMax 4 units can hold up to 800 lbs. (363kg).
- Floor tracks protect the floors from wear and tear and do not require to be mounted to the floor.
- Floor tracks compensate for rough or choppy floor surfaces.

Double-Deep Configurations can be created where two systems are joined together to increase the overall depth of the storage system for even greater storage capacity.

Choose the shelving type based on the application.

Both single- and double-deep systems can be used with Metro wire shelving (Super Erecta or Super Adjustable Super Erecta) and polymer shelving systems (MetroMax i and MetroMax Q).

Note: MetroMax 4 can be used on single-deep systems.



THE SECRET TO
HIGH-DENSITY
STORAGE IS THE
**ACTIVE
AISLE**
CONCEPT.

it's dense.

Top-Track® High-Density Storage



Metro Advantage.

All-Polymer Options Available



TRADITIONAL STORAGE USES UP TO 20' OF SPACE

HIGH DENSITY STORAGE . . . THE SMART WAY TO PUT SPACE TO WORK.



11.5'

Top-Track key facts

The guide track is positioned above the shelving system.

- Floors are easy to clean.
- Utility carts can easily be rolled into and out of the active aisle.
- The guide track compensates for uneven floor surfaces and keeps units in alignment.
- Mobile units are designed to address medium-duty applications. The weight capacity of a Top-Track mobile unit is 900 lb. (410kg).

Choose the shelving type based on your application.

Top-Track (single deep) can be used with Metro wire shelving (Super Erecta or Super Adjustable Super Erecta) and polymer shelving systems (MetroMax i and MetroMax Q).

Double-Deep configurations can be created when two systems are joined together to increase the overall depth of the storage system for even greater storage capacity. Double-Deep Top-Track is only available for Super Erecta and Super Adjustable Super Erecta style shelving.

HIGH-DENSITY STORAGE — QWIKTRAK®



qwikTRAK Storage System — {11.15}

Super Erecta, Super Erecta Pro, Super Adjustable, MetroMax Q, MetroMax i, MetroMax 4



MetroMax i qwikTRAK

Getting started:

Document the available floor space

- Actual length: Nominal track length + the nominal width of each end unit + 3" (76mm)
- Actual width: Nominal Shelf length + 3 1/2" (89mm)
- Actual height of a mobile qwikTRAK unit is: Nominal post height + 4.5" (115mm)

It is recommended that the tracks are installed at least 2" (52mm) from the wall.

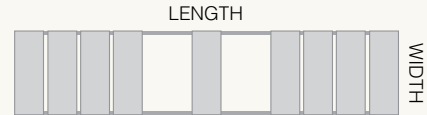

Shelves Sold Separately

MetroMax i — Pg. 12 Super Erecta — Pg. 42
 MetroMax 4 — Pg. 14 Super Adjustable — Pg. 37
 MetroMax Q — Pg. 16 Super Erecta Pro — Pg. 34

Choosing shelves: All end, intermediate, and mobile units must be 18" (457mm) or wider. Each stationary end and intermediate unit must have a minimum of four shelves. Super Adjustable shelves may be used for all tiers.

Stationary End Unit Kit (Choose one kit for each system)

Includes 74" high posts (1880mm) high stationary posts, and hardware necessary for connecting stationary end units to tracks. Shelves are sold separately.



Super Erecta, Super Erecta Pro, Super Adjustable Super Erecta				MetroMax Q Steel Posts			MetroMax Polymer Posts		
Approx. Pkd. Wt. (lbs.)	(kg)	Cat. No. Chrome-Plated	Cat. No. Metroseal 3 with Microban®	Approx. Pkd. Wt. (lbs.)	(kg)	Cat. No.	Approx. Pkd. Wt. (lbs.)	(kg)	Cat. No.
39.6	18.0	BTEC	BTEK3	42.0	19.1	BTEQ3	25.0	11.4	BTEX3

Stationary Intermediate Units

Required when overall desired track length exceeds 21' (6405mm). Optional when track length is under 21' (6405mm). Includes 74" high posts (1880mm) high stationary posts, and hardware necessary for connecting one stationary intermediate unit to tracks. Shelves are sold separately.

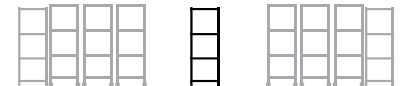

Super Erecta, Super Erecta Pro, Super Adjustable Super Erecta				MetroMax Q Steel Posts			MetroMax Polymer Posts		
Approx. Pkd. Wt. (lbs.)	(kg)	Cat. No. Chrome-Plated	Cat. No. Metroseal 3 with Microban®	Approx. Pkd. Wt. (lbs.)	(kg)	Cat. No.	Approx. Pkd. Wt. (lbs.)	(kg)	Cat. No.
22.6	10.3	BTAC	BTAK3	24.2	11.0	BTAQ3	15.7	7.1	BTA3

Mobile Units (One kit required per mobile unit)

Includes four 74" (1880mm) high mobile posts, four casters, donut bumpers, and other hardware to assemble a mobile unit. Shelves are sold separately.

Under normal conditions, aisle width of 30"-36" (760-914mm) is recommended. The storage of very large objects within the system, however, may require an aisle width larger than 36" (914mm).



Super Erecta, Super Erecta Pro, Super Adjustable Super Erecta				MetroMax Q Steel Posts			MetroMax Polymer Posts		
Approx. Pkd. Wt. (lbs.)	(kg)	Cat. No. Chrome-Plated	Cat. No. Metroseal 3 with Microban®	Approx. Pkd. Wt. (lbs.)	(kg)	Cat. No.	Approx. Pkd. Wt. (lbs.)	(kg)	Cat. No.
25.0	11.4	BTMC	BTMK3	27.0	12.3	BTMQ3	18.5	8.4	BTMX3

Note: Casters feature an acetyl grooved wheel. Chrome plated (BTMC) includes casters with plated steel components. BTMK3/BTMS/BTMQ3/BTMX3 include casters with stainless components.

Track Sets Includes tracks and hardware needed to assemble track runs up to 21' (6400mm).

✓ Indicates antimicrobial product.

Length (ft.)	(mm)	Approx. Pkd. Wt. (lbs.)	(kg)	Cat. No.	Length (ft.)	(mm)	Approx. Pkd. Wt. (lbs.)	(kg)	Cat. No.
2.5	762	4	1.8	BTS2.5NA	14	4267	19	8.6	BTS14NA
6	1828	9	4.1	BTS6NA	15	4572	21	9.5	BTS15NA
7	2135	10	4.5	BTS7NA	16	4877	22	10.0	BTS16NA
8	2440	11	5.0	BTS8NA	17	5182	23	10.5	BTS17NA
9	2743	13	5.9	BTS9NA	18	5486	25	11.4	BTS18NA
10	3048	14	6.4	BTS10NA	19	5791	26	11.8	BTS19NA
11	3352	15	6.8	BTS11NA	20	6096	27	12.3	BTS20NA
12	3657	17	7.7	BTS12NA	21	6400	29	13.2	BTS21NA
13	3962	18	8.2	BTS13NA					

Note: BTS2.5NA includes a joining kit to connect the tracks to other track sets.

Notes:

1. qwikTRAK is available with 74" posts (1880mm) as standard. Requests for TALLER posts must be reviewed by Metro Engineering. For applications requiring posts SHORTER than 74" (1880mm), contact your Metro representative.
2. Existing Metro Super Erecta, Super Adjustable, MetroMax Q, and MetroMax i shelving units can be retrofitted as part of a qwikTRAK installation.
3. Weight capacities for standard qwikTRAK: Super Erecta, Super Adjustable, MetroMax Q systems are designed to hold up to 2,000 lbs. (907kg) per shelving unit. MetroMax i stationary units can hold up to 2,000 lbs. (907kg); MetroMax i mobile units can hold up to 1,200 lbs. (544kg) per unit. MetroMax 4 stationary units can hold up to 2,000 lbs. (907kg); MetroMax 4 mobile units can hold up to 800 lbs. (363kg) per unit.
4. Added rigidity for heavily loaded systems. Super Erecta standard adjustment shelves provide the most rigid wire shelving mobile units; Recommended when configuring systems using 60" and 72" long shelves subject to the heaviest loads and frequent movement (multiple times daily). MetroMax Q epoxy coated steel posts may be used with MetroMax i shelves for added rigidity when managing sensitive packaged items and heavier unit loads; steel posts are corrosion resistant.



HIGH-DENSITY STORAGE — QWIKTRAK® DOUBLE DEEP

Double-Deep qwikTRAK Storage System — {11.15}

Super Erecta, Super Erecta Pro, Super Adjustable, MetroMax Q, MetroMax i

Getting started:

Document the available floor space

- Actual length: Nominal track length + the nominal width of each end unit + 3" (76mm)
- Actual width: Nominal Shelf length + 3 1/2" (89mm)
- Actual height of a mobile qwikTRAK unit is: Nominal post height + 4.5" (115mm)

It is recommended that the tracks are installed at least 2" (52mm) from the wall.

Shelves Sold Separately

MetroMax i — Pg. 12 Super Erecta — Pg. 42
 MetroMax 4 — Pg. 14 Super Adjustable — Pg. 37
 MetroMax Q — Pg. 16 Super Erecta Pro — Pg. 34

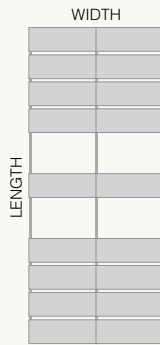

Choosing shelves: All end, intermediate, and mobile units must be 18" (457mm) or wider. Each stationary end and intermediate unit must have a minimum of four shelves. Super Adjustable shelves may be used for all tiers; Mobile units require standard Super Erecta for top and bottom shelves.

Stationary End Unit Kit (Choose One per double-deep System)

Includes 74" high posts (1880mm) high stationary posts, and hardware necessary for connecting stationary end units to tracks. Shelves are sold separately



Super Erecta, Super Erecta Pro, Super Adjustable Super Erecta

Approx. Pkd. Wt. (lbs.) (kg)	Cat. No. Chrome-Plated	Cat. No. Metroseal 3 with Microban®	Cat. No. Stainless Steel
73.6 33.5	LBTEC	LBTEK3	LBTES

MetroMax Q Steel Posts

MetroMax Polymer Posts

Approx. Pkd. Wt. (lbs.) (kg)	Cat. No.	Approx. Pkd. Wt. (lbs.) (kg)	Cat. No.
76.3 34.7	LBTEQ3	42.3 19.2	LBTEX3

Stationary Intermediate Units

Includes 74" high posts (1880mm) high stationary posts and hardware necessary for connecting one double-deep stationary intermediate unit to tracks and anchoring tracks to the floor. Shelves are sold separately.

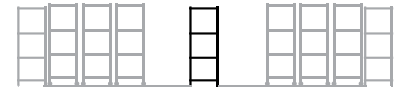

Super Erecta, Super Erecta Pro, Super Adjustable Super Erecta

Approx. Pkd. Wt. (lbs.) (kg)	Cat. No. Chrome-Plated	Cat. No. Metroseal 3 with Microban®	Cat. No. Stainless Steel
39.6 18.0	LBTA C	LBTA K3	LBTA S

MetroMax Q Steel Posts

MetroMax Polymer Posts

Approx. Pkd. Wt. (lbs.) (kg)	Cat. No.	Approx. Pkd. Wt. (lbs.) (kg)	Cat. No.
41.3 18.8	LBTA Q3	24.3 11.0	LBTA X3

Mobile Units (One kit required per Double-Deep Mobile Unit)

Includes (8) 74" (1880mm) high -UP posts, (4) V-groove casters, (1) stainless steel center channel caster assembly, donut bumpers, Tie Bar Brackets, and other hardware. Shelves are sold separately.

Under normal conditions, aisle width of 30"-36" (760-914mm) is recommended. The storage of very large objects within the system, however, may require an aisle width larger than 36" (914mm).

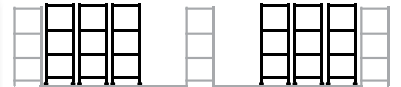

Super Erecta, Super Erecta Pro, Super Adjustable Super Erecta

Shelf Width (in.) (mm)	Cat. No. Chrome	Cat. No. Metroseal 3 with Microban®	Cat. No. Stainless Steel
18 457	LBTM18C	LBTM18K3	LBTM18S
21 530	LBTM21C	LBTM21K3	LBTM21S
24 610	LBTM24C	LBTM24K3	LBTM24S

MetroMax Q Steel Posts

MetroMax Polymer Posts

Cat. No.	Cat. No.
LBTM18Q3	LBTM18X3
LBTM21Q3	—
LBTM24Q3	LBTM24X3

Note: Casters feature acetyl grooved wheel. Chrome kit includes casters with steel components. Metroseal 3/Stainless Steel/MetroMax Q/MetroMax i kits include casters with stainless components.

Track Sets Includes tracks and hardware needed to assemble Double-Deep qwikTRAK systems up to 21' (6400mm).

☑ Indicates antimicrobial product.

Length (ft.) (mm)	Approx. Pkd. Wt. (lbs.) (kg)	Cat. No.	Length (ft.) (mm)	Approx. Pkd. Wt. (lbs.) (kg)	Cat. No.
2.5 762	4 1.8	LBTS2.5NA	14 4267	19 8.6	LBTS14NA
6 1828	9 4.1	LBTS6NA	15 4572	21 9.5	LBTS15NA
7 2135	10 4.5	LBTS7NA	16 4877	22 10.0	LBTS16NA
8 2440	11 5.0	LBTS8NA	17 5182	23 10.5	LBTS17NA
9 2743	13 5.9	LBTS9NA	18 5486	25 11.4	LBTS18NA
10 3048	14 6.4	LBTS10NA	19 5791	26 11.8	LBTS19NA
11 3352	15 6.8	LBTS11NA	20 6096	27 12.3	LBTS20NA
12 3657	17 7.7	LBTS12NA	21 6400	29 13.2	LBTS21NA
13 3962	18 8.2	LBTS13NA			

Note: LBTS2.5NA includes a joining kit to connect the track to other track sets.

Notes:

1. qwikTRAK is available with 74" posts (1880mm) as standard. Requests for TALLER posts must be reviewed by Metro Engineering. For applications requiring posts SHORTER than 74" (1880mm), contact your Metro representative.
2. Maximum allowable shelf length for use with a double-deep system is 60" (1524mm).
3. The maximum width of a double-deep configuration is 10'6" (3200mm). (i.e., two systems, each having 60" (1524mm) long shelves, plus 6" (150mm) for qwikTRAK components).
4. Weight capacities: Double Deep Mobile Units — Super Erecta/Super Adjustable, Super Erecta/MetroMax Q: 3,000 lbs. (1364kg) evenly distributed. MetroMax i: 1,800 lbs. (818kg) evenly distributed. Stationary End and Intermediate Units — Each end and intermediate double deep unit consists of two independent stationary shelving units positioned side by side. Each shelving unit has a maximum weight capacity of 2,000 lbs. (907kg).

THE ONLY ALL-POLYMER SHELVING

strong enough
for overhead track
systems.



MetroMax.

Top-Track Storage System — {9.29}

Polymer Shelving — MetroMax i, MetroMax 4, MetroMax Q



Getting started:

Document the available floor space

- Actual length: Nominal track length + the nominal width of each end unit + 2" (51mm)
- Actual width: Nominal Shelf length + 3 1/2" (89mm)
- Actual height of system is approx. 87" (2210mm)

It is recommended that the tracks are installed at least 5" (127mm) from the wall.

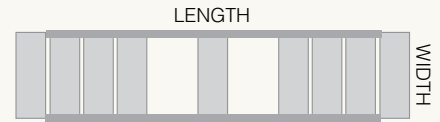

Shelves Sold Separately

MetroMax i — Pg. 12
 MetroMax 4 — Pg. 14
 MetroMax Q — Pg. 16

Stationary End Unit Kit (Order one per Top-Track system)

Includes hardware and components to connect track sets to two stationary end units. 86" (2185mm) posts included. Shelves are ordered separately.

		i&4 Cat. No. End Unit Kit	Q Cat. No. End Unit Kit
Fits Shelf Width (in.)	(mm)		
18	457	MXTTE18	MQTTE18
21	530	MXTTE21	MQTTE21
24	610	MXTTE24	MQTTE24

The system compensates for uneven floor surfaces. Floor should be smooth and free from large cracks or raised obstacles. Maximum load capacity for mobile units is 900 lbs. (400kg).

Stationary Intermediate Unit Kit

Required when overall desired track length exceeds 21' (6405mm). Optional when track length is under 21' (6405mm). Includes 74" high posts (1880mm) high stationary posts, and hardware necessary for connecting one stationary intermediate unit to tracks. Shelves are sold separately.

		i&4 Cat. No. Intermediate Unit Kit	Q Cat. No. Intermediate Unit Kit
Fits Shelf Width (in.)	(mm)		
18	457	MXTTA18	MQTTA18
21	530	MXTTA21	MQTTA21
24	610	MXTTA24	MQTTA24

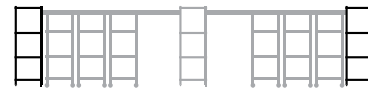

Mobile Unit Kit (Order one per mobile unit)

Kit includes 74" (1880mm) posts, rigid casters, caster channels, bumpers, and roller assemblies. Shelves are sold separately.

		i&4		Q		Q	
		with Plated Casters		with Stainless Casters		with Stainless Casters	
Fits Shelf Width (in.)	(mm)	Cat. No.	Cat. No.	Cat. No.	Cat. No.	Cat. No.	Cat. No.
18	457	MXTTM18C	MXTTM18S	MQTTM18C	MQTTM18S	MQTTM18C	MQTTM18S
21	530	MXTTM21C	MXTTM21S	MQTTM21C	MQTTM21S	MQTTM21C	MQTTM21S
24	610	MXTTM24C	MXTTM24S	MQTTM24C	MQTTM24S	MQTTM24C	MQTTM24S

Under normal conditions, aisle width of 30"-36" (760-914mm) is recommended. The storage of very large objects within the system, however, may require an aisle width larger than 36" (914mm).



Track Sets (One track set is required between stationary units)

Includes necessary sections of track for assembling track runs of 6' to 21' (1830-6405mm).

				Approx. Pkd. Wt. (kg)												
Length (feet)		(mm)		(lbs.)		(kg)		Length (feet)		(mm)		(lbs.)		(kg)		
2 1/2	762	15	6.8	TTS2.5NA				14	4267	98	44.1	TTS14NA				
6	1828	40.5	18.2	TTS6NA				15	4572	106.5	47.9	TTS15NA				
7	2135	47.5	21.3	TTS7NA				16	4877	113.5	51	TTS16NA				
8	2440	56	25.2	TTS8NA				17	5182	121	54.4	TTS17NA				
9	2743	62.5	28.1	TTS9NA				18	5486	128	51.6	TTS18NA				
10	3048	69.5	31.2	TTS10NA				19	5791	135	60.7	TTS19NA				
11	3353	76.5	34.4	TTS11NA				20	6096	142	63.9	TTS20NA				
12	3657	83.5	37.5	TTS12NA				21	6400	149	67	TTS21NA				
13	3962	92	41.4	TTS13NA												

Notes:

1. Mobile, stationary end, and intermediate units must have a minimum of 4 shelves.
2. Mobile Units: If 18" (457mm) wide mobile units are planned, the maximum allowable size shelf is 60" (1524mm) long. If 18" (457mm) wide by 60" (1524mm) long mobile units are planned, a maximum of five 18" (457mm) mobile units are allowable between two stationary units. 18" (457mm), 21" (530mm) and 24" (610mm) wide mobile units can be intermixed in a given system. The standard system requires 74" (1880mm) posts on the mobile units. Recommended maximum load rating for a mobile unit is 900 lbs. (410kg).
3. To accommodate bumpers, the actual size of a mobile unit is 2.5" (63.5mm) wider than the shelf width shown. For example, an 18"(457mm) wide unit is actually 20.5" (521mm).
4. MetroMax Q epoxy coated steel posts may be used with MetroMax i shelves for added rigidity; steel posts are corrosion resistant.

Note: TTS2.5NA includes a joining kit to connect the tracks to longer track sections.



Top-Track Storage System — {11.12}

Wire Shelving — Super Erecta, Super Erecta Pro, Super Adjustable



Super Erecta® Top-Track®

Getting started:

Document the available floor space

- Actual length: Nominal track length + the nominal width of each end unit + 2" (51mm)
- Actual width: Nominal Shelf length + 3 1/2" (89mm)
- Actual height of system is approx. 87" (2210mm)

It is recommended that the tracks are installed at least 5" (127mm) from the wall.

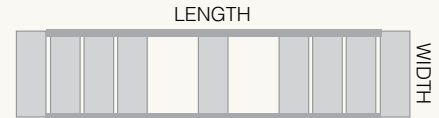

Shelves Sold Separately

- Super Erecta — Pg. 42
- Super Adjustable — Pg. 37
- Super Erecta Pro — Pg. 34

Choosing shelves: Each stationary end and intermediate unit must have a minimum of four shelves. For all Super Adjustable applications, the top and bottom shelves must be round collar Super Erecta shelves. All shelves are ordered separately.

Stationary End Unit Kits (One kit is required per single system)

Includes hardware necessary for connecting stationary end units to track. 86" (2185mm) posts are included. Shelves sold separately.

Shelf Width (in.)	Shelf Width (mm)	Approx. Pkd. Wt. (lbs.) (kg)		Cat. No. Chrome-Plated	Cat. No. Metroseal 3 with Microban®	Cat. No. Stainless Steel
18	457	11	4.9	TTE18C	TTE18K3	TTE18S
21	530	11.5	5.1	TTE21C	TTE21K3	TTE21S
24	610	12	5.4	TTE24C	TTE24K3	TTE24S



Stationary Intermediate Units

Required when overall desired track length exceeds 21' (6405mm). Optional when track length is under 21' (6405mm). Includes 74" high posts (1880mm) high stationary posts, and hardware necessary for connecting one stationary intermediate unit to tracks. Shelves are sold separately.

Shelf Width (in.)	Shelf Width (mm)	Approx. Pkd. Wt. (lbs.) (kg)		Cat. No. Chrome-Plated	Cat. No. Metroseal 3 with Microban®	Cat. No. Stainless Steel
18	457	7.5	3.3	TTA18C	TTA18K3	TTA18S
21	530	8	3.6	TTA21C	TTA21K3	TTA21S
24	610	8.5	3.8	TTA24C	TTA24K3	TTA24S

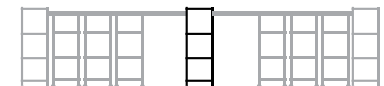

Mobile Unit Kits (One kit required per mobile unit)

Kit includes special 74" (1880mm) posts, casters/caster channels, donut bumpers, and roller bearing assemblies. Shelves are sold separately.

If 18" wide mobile units are planned, the maximum allowable length shelf is 60" (1524mm) long. If 18" (457mm) wide by 60" (1524mm) long mobile units are planned, a maximum of five 18" (457mm) mobile units are allowable between two stationary units. 18" (457mm), 21" (530mm), 24" (610mm) wide mobile units can be intermixed in a given system.

Shelf Width (in.)	Shelf Width (mm)	Overall Width (in.)	Overall Width (mm)	Approx. Pkd. Wt. (lbs.) (kg)		Cat. No. Chrome-Plated	Cat. No. Metroseal 3 with Microban®	Cat. No. Stainless Steel
18	457	20 1/4	514	32	14.4	TTM18C	TTM18K3	TTM18S
21	530	23 1/4	590	33	14.8	TTM21C	TTM21K3	TTM21S
24	610	26 1/4	667	34	15.3	TTM24C	TTM24K3	TTM24S

Note: Casters feature wheels with polyurethane tread. Chrome plated kits include casters with plated steel components. Metroseal 3 and Stainless Steel kits include casters with stainless steel components.

Under normal conditions, aisle width of 30"-36" (760-914mm) is recommended. The storage of very large objects within the system, however, may require an aisle width larger than 36" (914mm).



Track Sets Includes tracks and hardware needed to assemble track runs up to 21' (6400mm).

Length (feet)	Length (mm)	Approx. Pkd. Wt. (lbs.) (kg)		Cat. No.	Length (feet)	Length (mm)	Approx. Pkd. Wt. (lbs.) (kg)		Cat. No.
2 1/2	762	15	6.8	TTS2.5NA	14	4267	98	44.1	TTS14NA
6	1828	40.5	18.2	TTS6NA	15	4572	106.5	47.9	TTS15NA
7	2135	47.5	21.3	TTS7NA	16	4877	113.5	51	TTS16NA
8	2440	56	25.2	TTS8NA	17	5182	121	54.4	TTS17NA
9	2743	62.5	28.1	TTS9NA	18	5486	128	51.6	TTS18NA
10	3048	69.5	31.2	TTS10NA	19	5791	135	60.7	TTS19NA
11	3353	76.5	34.4	TTS11NA	20	6096	142	63.9	TTS20NA
12	3657	83.5	37.5	TTS12NA	21	6400	149	67	TTS21NA
13	3962	92	41.4	TTS13NA					

Note: TTS2.5NA includes a joining kit to connect the tracks to longer track sections.

Additional Notes:

1. To accommodate bumpers, the actual size of a mobile unit is 2.5" (63.5mm) wider than the shelf width shown. For example, an 18" (457mm) wide unit is actually 20.5" (52mm).
2. Recommended maximum load rating for a mobile unit is 900 lbs. (410kg). Floor should be level, smooth, and free from large cracks and raised obstacles.
3. Added rigidity for heavily loaded systems. Super Erecta standard adjustment shelves provide the most rigid wire shelving mobile units; Recommended when configuring systems using 60" (1524mm) and 72" (1829mm) long shelves subject to the heaviest loads and frequent movement (multiple times daily).

Easy Order with one Part #.

Get all you need to create efficient high-density storage under one simple part number.

10ft. Fits spaces 10ft. and over

Complete System Length		System Width		Chrome Top-Track Easy Order Model	Super Erecta Pro Top-Track Easy Order Model
(ft./in.)	(mm)	(in.)	(mm)		
9' 7"	2921	48	1219	TT10-E2148M1848C	TT10-E2148M1848P
9' 7"	2921	60	1524	TT10-E2160M1860C	TT10-E2160M1860P

Models Contain

(1) 6' Track Set, (8) 86" Posts, (1) 18" Tie Bar End Kit, (8) 74" Top Trk Mobile Posts, (2) 18" Mobile Kits, (16) Shelves

Note: Chrome systems use chrome posts and plated casters. SE Pro uses Metroseal 3 Posts and Stainless casters.



21" (530mm) End Width
18" (457mm) Mobile Width
48" (1219mm) or 60" (1524mm) Shelf Length

12ft. Fits spaces 12ft. and over

Complete System Length		System Width		Chrome Top-Track Easy Order Model	Super Erecta Pro Top-Track Easy Order Model
(ft./in.)	(mm)	(in.)	(mm)		
11' 7"	3531	48	1219	TT12-E2448M1848C	TT12-E2448M1848P
11' 7"	3531	60	1524	TT12-E2460M1860C	TT12-E2460M1860P

Models Contain

(1) 7.5' Track Set, (8) 86" Posts, (1) 18" Tie Bar End Kit, (12) 74" Top Trk Mobile Posts, (3) 18" Mobile Kits, (20) Shelves

Note: Chrome systems use chrome posts and plated casters. SE Pro uses Metroseal 3 Posts and Stainless casters.



24" (610mm) End Width
18" (457mm) Mobile Width
48" (1219mm) or 60" (1524mm) Shelf Length

14ft. Fits spaces 14ft. and over

Complete System Length		System Width		Chrome Top-Track Easy Order Model	Super Erecta Pro Top-Track Easy Order Model
(ft./in.)	(mm)	(in.)	(mm)		
13' 7"	4140	48	1219	TT14-E2448M1848C	TT14-E2448M1848P
13' 7"	4140	60	1524	TT14-E2460M1860C	TT14-E2460M1860P

Models Contain

(1) 9.5' Track Set, (8) 86" Posts, (1) 18" Tie Bar End Kit, (16) 74" Top Trk Mobile Posts, (4) 18" Mobile Kits, (24) Shelves

Note: Chrome systems use chrome posts and plated casters. SE Pro uses Metroseal 3 Posts and Stainless casters.



24" (610mm) End Width
18" (457mm) Mobile Width
48" (1219mm) or 60" (1524mm) Shelf Length

16ft. Fits spaces 16ft. and over

Complete System Length		System Width		Chrome Top-Track Easy Order Model	Super Erecta Pro Top-Track Easy Order Model
(ft./in.)	(mm)	(in.)	(mm)		
15' 7"	4750	48	1219	TT16-E2448M2448C	TT16-E2448M2448P
15' 7"	4750	60	1524	TT16-E2460M2460C	TT16-E2460M2460P

Models Contain

(1) 11.5' Track Set, (8) 86" Posts, (1) 18" Tie Bar End Kit, (16) 74" Top Trk Mobile Posts, (4) 18" Mobile Kits, (24) Shelves.

Note: Chrome systems use chrome posts and plated casters. SE Pro uses Metroseal 3 Posts and Stainless casters.



24" (610mm) End Width
24" (610mm) Mobile Width
48" (1219mm) or 60" (1524mm) Shelf Length

The numbers don't lie...

30% More Storage.

Conventional 16' of Storage



16' of Top-Track Storage



Double-Deep Top-Track Storage System — {11.12}

Wire Shelving — Super Erecta, Super Erecta Pro, Super Adjustable

Stationary End Units (One kit required for entire double deep configuration)
Includes hardware necessary for connecting stationary end units in double-deep systems and connecting to an overhead track set. 86" (2185mm) posts included. Shelves sold separately.

Shelf Width (in.)	Shelf Width (mm)	Approx. Pkd. Wt. (lbs.)	Approx. Pkd. Wt. (kg)	Cat. No. Chrome-Plated
18	457	33	14.8	LTTE18C
21	530	37	16.6	LTTE21C
24	610	41	18.4	LTTE24C



Stationary Intermediate Units (One kit required for Intermediate units connected end-to-end) Includes hardware necessary for connecting intermediate units in double-deep systems and connecting to an overhead track set on each side. 86" (2185mm) posts included.

Shelf Width (in.)	Shelf Width (mm)	Approx. Pkd. Wt. (lbs.)	Approx. Pkd. Wt. (kg)	Cat. No. Chrome-Plated
18	457	18	8	LTTA18C
21	530	20	9	LTTA21C
24	610	22	9.9	LTTA24C

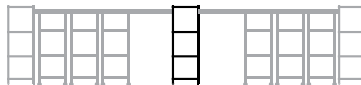

Mobile Unit Kits (One kit required per mobile unit)

Includes posts, casters, caster channels, donut bumpers, roller bearing assemblies, and tie-together hardware to connect two mobile units.

Shelf Width (in.)	Shelf Width (mm)	Overall Width (in.)	Overall Width (mm)	Approx. Pkd. Wt. (lbs.)	Approx. Pkd. Wt. (kg)	Cat. No. Chrome-Plated
18	457	20 ¹ / ₄	514	72	32.4	LTTM18C
21	530	23 ¹ / ₄	590	75	33.7	LTTM21C
24	610	26 ¹ / ₄	667	78	35	LTTM24C



Track Sets Includes necessary sections of track for assembling track runs up to 21' (6400mm). For track sizes within the even 1-foot (305mm) increments, contact your Metro representative. Only one track set is required between stationary units.

Length (feet)	Length (mm)	Approx. Pkd. Wt. (lbs.)	Approx. Pkd. Wt. (kg)	Cat. No.	Length (feet)	Length (mm)	Approx. Pkd. Wt. (lbs.)	Approx. Pkd. Wt. (kg)	Cat. No.
2 ¹ / ₂	762	15	6.8	TTS2.5NA	14	4267	98	44.1	TTS14NA
6	1828	40.5	18.2	TTS6NA	15	4572	106.5	47.9	TTS15NA
7	2135	47.5	21.3	TTS7NA	16	4877	113.5	51	TTS16NA
8	2440	56	25.2	TTS8NA	17	5182	121	54.4	TTS17NA
9	2743	62.5	28.1	TTS9NA	18	5486	128	51.6	TTS18NA
10	3048	69.5	31.2	TTS10NA	19	5791	135	60.7	TTS19NA
11	3353	76.5	34.4	TTS11NA	20	6096	142	63.9	TTS20NA
12	3657	83.5	37.5	TTS12NA	21	6400	149	67	TTS21NA
13	3962	92	41.4	TTS13NA					

Note: TTS2.5NA includes a joining kit to connect the tracks to longer track sections.

Notes:

- Each stationary end and intermediate unit **must** have a minimum of four shelves. For all Super Adjustable applications, the top and bottom shelves must be non "quick adjust" Super Erecta shelves.
- The standard Double Deep Top-Track system requires the use of 86" (2185mm) posts (i.e., 86P) on the stationary end and intermediate units. **Shelves for the stationary end and intermediate units are sold separately.**
- The mobile unit kits include special 74" (1880mm) posts with casters. **Shelves for mobile units are sold separately.**
- Under normal conditions, an aisle width of 30"-36" (760-914mm) is recommended. The storage of very large objects within the system, however, may require an aisle width larger than 36" (914mm).
- Two intermediate shelving units connected end-to-end are required when the track length exceeds 21 feet (6400mm). Stationary intermediate shelving units may be used at the discretion of the user when track lengths are less than 21 feet (6400mm).
- The maximum Double Deep system configuration is 10'6" (3200mm) (i.e., two systems, each having 60" (1524mm) long shelves, plus 6" (150mm) for Top-Track components).
- Ease of rollability for the mobile units is an important consideration in evaluating Top-Track as a possible storage alternative. The floor should be level, smooth, and free from large cracks and raised obstacles. Two mobile shelving units connected end-to-end and loaded with between 800 to 1,200 lbs. (365-550kg) will require a human effort range (in lbs. of human force) of between 18-24 lbs. (8-11kg) to move the unit from a complete stop. Subjectively, an average 110 lb. (50kg) person will perceive this as acceptable effort levels. For loads over 1,200 lbs. (550kg), contact your Metro representative.
- Mobile units should have the top shelf positioned as close as possible to the track.
- To accommodate bumpers, the actual size of a mobile unit is 2.5" (63.5mm) wider than the shelf width shown. For example, an 18" (457mm) wide unit is actually 20.5" (52mm).
- To calculate the overall length of a Super Erecta Top Track System, add the following:
Nominal track length + Nominal widths of each end unit + 1.5" (38mm).

Getting started:

Document the available floor space

- Actual length: Nominal track length + the nominal width of each end unit + 2" (51mm)
- Actual width: Nominal Shelf length + 3¹/₂" (89mm)
- Actual height of system is approx. 87" (2210mm)

It is recommended that the tracks are installed at least 5" (127mm) from the wall.

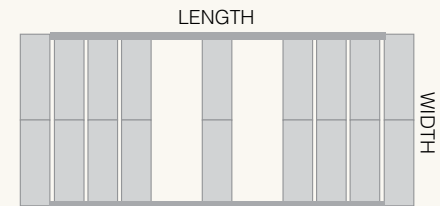

Shelves Sold Separately

Super Erecta — Pg. 42
Super Adjustable — Pg. 37
Super Erecta Pro — Pg. 34

Note: for other finishes please contact your Metro representative.

For Top-Track accessories, see page 118.

Seismic Top-Track® Single Length System

End Unit Kit:

Includes four shelves, four staked posts, bracket bars, sway braces (for top, back, and end), anchor plates, foot plates, tubular braces, clamps, and assembly hardware.

Description	Cat. No.
Kit for 48" (1219mm) Stationary End Unit	SA48TTS
Kit for 54" (1370mm) Stationary End Unit	SA54TTS
Kit for 60" (1524mm) Stationary End Unit	SA60TTS

Strut Kit:

Description	Cat. No.
Kit for 48" (1219mm) Wide Unit	TTB48STRUT
Kit for 54" (1370mm) Wide Unit	TTB54STRUT
Kit for 60" (1524mm) Wide Unit	TTB60STRUT

Note: Floor anchoring hardware not included.

Example: For a complete "Single-Length Top-Track® System," the following would be required: Two Stationary End Units, One Track Set* (11-foot [3355mm] maximum), One Center Strut (if track length exceeds 7 feet), Mobile Units.

Note: Posts and shelves are included in the end and intermediate unit kits. Shelves are sold separately for the mobile unit.

Add track sets and mobile unit kits, refer to page 116.

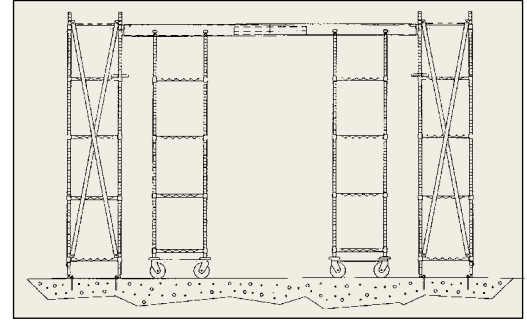

Single-Length System

Seismic Top-Track® Double Length System

End Unit Kits:

Includes four shelves, four staked posts, bracket bars, sway braces (for top, back, and end), anchor plates, foot plates, tubular braces, clamps, and assembly hardware.

Description	Cat. No.
Kit for 48" (1219mm) Stationary End Unit	SA48TTS
Kit for 54" (1370mm) Stationary End Unit	SA54TTS
Kit for 60" (1524mm) Stationary End Unit	SA60TTS

Intermediate Unit Kits:

Includes eight shelves, eight staked posts, bracket bars, sway braces (for top, back, and end), anchor plates, foot plates, tubular braces, clamps, and assembly hardware.

Description	Cat. No.
Kit for 48" (1219mm) Stationary Intermediate Unit	SA48TTIS
Kit for 54" (1370mm) Stationary Intermediate Unit	SA54TTIS
Kit for 60" (1524mm) Stationary Intermediate Unit	SA60TTIS

Strut Kit:

Description	Cat. No.
Kit for 48" (1219mm) Wide Unit	TTB48STRUT
Kit for 54" (1370mm) Wide Unit	TTB54STRUT
Kit for 60" (1524mm) Wide Unit	TTB60STRUT

Note: Floor anchoring hardware not included.

Example: For a complete "Double-Length Top-Track® System," the following would be required: Two Stationary End Units, Two Track Sets* (11-foot [3355mm] maximum), One Intermediate Unit, Two Center Struts (if track length exceeds 7 feet [2135mm]), Mobile Units.*

Note: Posts and shelves are included in the end and intermediate unit kits. Shelves are sold separately for the mobile unit.

Notes:

- Each installation must have two stationary end units for a single-track length of 7' (2135mm) to 11' (3355mm).
- A center strut is required for each track section over 7' (2135mm).
- For track lengths over 11' (3355mm), an intermediate unit is required, thus creating a double-length system.
- Seismic Top-Track is based upon a weight-loading capacity of 25 lbs. (11kg) per square foot on a four-shelf stationary and mobile units, with maximum of 900 lbs. (408kg) per mobile unit. Additional shelves may be added, but are limited to a maximum load of 25 lbs. (11kg) per cubic foot per unit.
- A maximum of four 21" (640mm) or 24" (610mm), or five 18" (457mm) mobile units are allowed per an 11' (3355mm) track length, with no more than a 900 lb. (408kg) weight capacity per mobile unit.
- Stationary End Units are available in 24"x48" (610x1219mm), 24"x54" (610x1370mm), and 24"x60" (610x1524mm).
- Seismic Top-Track design is based on the use of HR concrete, at least 5 1/2" (140mm) thick, with a compressive strength of 3,000 psi (211kg/cm).
- To calculate the overall length of a Super Erecta Top Track System, add the following: Nominal track length + Nominal widths of each end unit + 1.5" (38mm).

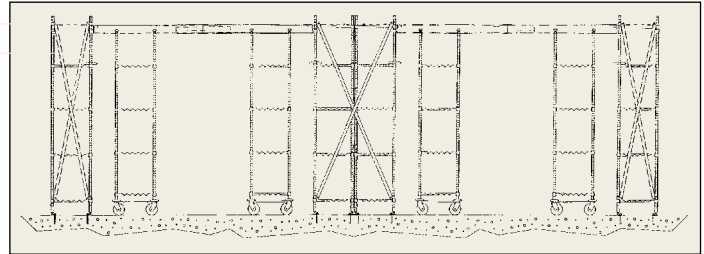

Double-Length System

Add track sets and mobile unit kits, refer to page 116.

See page 120 for Stationary Seismic shelving.

Notes:

- Floor anchors are not included. The structural engineer of record must verify that the anchorage bolt and building structure are adequate for the applied load.
- For Seismic Top-Track, the highest load shelf must be no more than 60" (1524mm) from the floor.
- For Seismic Top-Track, a unit must have no more than four loaded shelves within 60" (1524mm) height.
- If a fifth shelf is used, it must serve only as a cover and not be used for load bearing.
- Each shelving unit, whether single or "back-to-back," cannot connect to other shelving units or walls.

Top-Track® Floor Pad Protectors — {9.29} {11.12}

Use for both MetroMax Top-Track and Super Erecta Top-Track Systems.

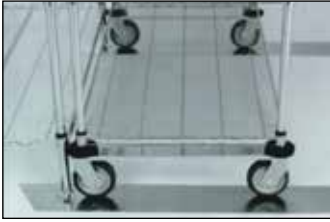

Top-Track® Floor Protectors

For Track Length (ft.) (mm)		Cat. No.	For Track Length (ft.) (mm)		Cat. No.
6	1828	FPS6N	14	4267	FPS14N
7	2135	FPS7N	15	4572	FPS15N
8	2440	FPS8N	16	4877	FPS16N
9	2743	FPS9N	17	5182	FPS17N
10	3048	FPS10N	18	5486	FPS18N
11	3353	FPS11N	19	5791	FPS19N
12	3657	FPS12N	20	6096	FPS20N
13	3962	FPS13N	21	6400	FPS21N



Top-Track® Wall Mount Bracket

Top-Track® Wall Mount Bracket — {11.12}

Used to attach one set of tracks to the wall. Eliminates the need for a stationary end unit. Includes one pair of wall brackets and hardware to attach tracks to the wall brackets. Hardware to attach the wall brackets to the wall is NOT included.

Cat. No. TTWM



Top-Track® Stop Plate Kit

Top-Track® Stop Plate Kit — {11.12}

Used in conjunction with the Wall Mount Bracket Kit. The stop plates bolt to the underside of the track next to the wall brackets to prevent the mobile units from bumping into the wall.

Cat. No. TTSTP

Metro Tip:

Floor pad protectors compensate for soft flooring materials by protecting the floor from wear and tear. For new construction projects, it is recommended that flooring of suitable durability is used in areas where Top-Track will be installed.



qwikTRAK Stop Plate Kit

qwikTRAK Stop Plate Kit — {11.15}

Eliminates the need for a stationary end unit. The kit contains two “L-shaped” stop plates that mount to the ends of the floor tracks. The stop plates prevent a mobile unit from rolling off the end of the tracks.

Cat. No. BTSP

Consult your Metro representative for guidance on configuring a qwikTRAK system using this kit.

Stop plates (kit of two) shown mounted to the end plates on the floor tracks.

EFFICIENCY IS ON THE RISE

Short on floor space?
Try going vertical.



Super Erecta Hi-Rise Shelving

Super Erecta® Hi-Rise Shelving — {10.17}

- For light-duty storage applications where floor space is at a premium.
- Construct shelving up to 24 feet (7315mm) high — 3 times the height of conventional shelving
- Metro's computerized engineering system assures correct specifications and load rating of Hi-Rise materials for your application.

All Hi-Rise installations must be reviewed and approved by Metro Engineering. Hi-Rise certification plate supplied. Only Super Erecta and Super Adjustable Super Erecta wire shelves (found on pages 37) can be used in Hi-Rise applications. Contact Metro customer service or your local Metro representative for details.

Metro Tip:

One frequently overlooked opportunity to gain additional storage capacity is the efficient use of vertical space. By connecting Super Erecta posts, storage areas may be created that utilize every available cubic foot of unused vertical air space.

Material part numbers will be provided by Metro Product Development upon review of application.

Seismic Shelving Systems

Super Erecta® (SES), Super Adjustable Super Erecta® (SASE), qwikSLOT® (QS), HD Super® (HD), MetroMax® Q (Q)

Seismic Bolt Plates Kits:

For 1" (25mm) diameter, Super Erecta Shelf, Super Adjustable Super Erecta, qwikSLOT stationary post assemblies. Kit includes plate assemblies and hardware to mount plates to posts. Floor anchors are not included.

Description	Qty.	Dimensions (Width/Length/Height) (in.) (mm)		Cat. No.
		(in.)	(mm)	
One-Post Bolt Plate, 1/4" (6mm)	4	2 ⁷ / ₁₆ x7x ¹ / ₄	73x178x6	SASES25BP-1
Two-Post Bolt Plate, 1/4" (6mm)	2	2 ⁷ / ₁₆ x11x ¹ / ₄	73x279x6	SASES25BP-2
Four-Post Bolt Plate, 1/4" (6mm)	1	2 ⁷ / ₁₆ x11x ¹ / ₄	73x279x6	SASES25BP-4
One-Post Bolt Plate, 1/2" (13mm)	4	7x7x ¹ / ₂	178x178x13	SASES50BP-1
Two-Post Bolt Plate, 1/2" (13mm)	2	7x12x ¹ / ₂	178x305x13	SASES50BP-2
Four-Post Bolt Plate, 1/2" (13mm)	1	7x12x ¹ / ₂	178x305x13	SASES50BP-4

For 1.5" (38mm) diameter HD and trilobal Q stationary post assemblies. Kit includes plates and hardware to mount plates to posts. Floor anchors are not included.

Description	Qty.	Dimensions (Width/Length/Height) (in.) (mm)		Cat. No.
		(in.)	(mm)	
One-Post Bolt Plate, 1/4" (6mm)	4	2 ⁷ / ₁₆ x7x ¹ / ₄	73x178x6	SAQHD25BP-1
Two-Post Bolt Plate, 1/4" (6mm)	2	2 ⁷ / ₁₆ x11x ¹ / ₄	73x279x6	SAQHD25BP-2
Four-Post Bolt Plate, 1/4" (6mm)	1	2 ⁷ / ₁₆ x11x ¹ / ₄	73x279x6	SAQHD25BP-4
One-Post Bolt Plate, 1/2" (13mm)	4	7x7x ¹ / ₂	178x178x13	SAQHD50BP-1
Two-Post Bolt Plate, 1/2" (13mm)	2	7x12x ¹ / ₂	178x305x13	SAQHD50BP-2
Four-Post Bolt Plate, 1/2" (13mm)	1	7x12x ¹ / ₂	178x305x13	SAQHD50BP-4

Required Components:
For seismic requirements, simply add floor bolt-plates to standard Metro stationary shelving configurations and follow the installation and usage guidelines. Just add floor plates

Example A
Requires one 1-post starter kit. (ie. SASES25BP-1).

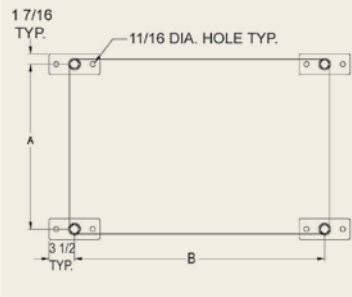

Example B
Requires one starter kit, (ie. SASES25BP-1) and one 2-post adder kit, (ie. SASES25BP-2). Include one additional adder kit for each subsequent shelving unit added to the run.

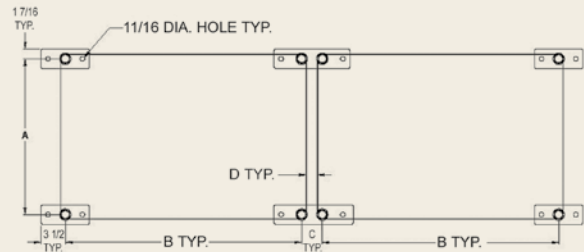

Example C
Requires one 1-post starter kit, (ie. SASES25BP-1), two 2-post adder kits (ie. SASES25BP-2), and one 4-post adder kit, (ie. SASES25BP-4). Include one of each adder kit, (ie. one 2-post kit and one 4-post kit), for each additional pair of shelving units.

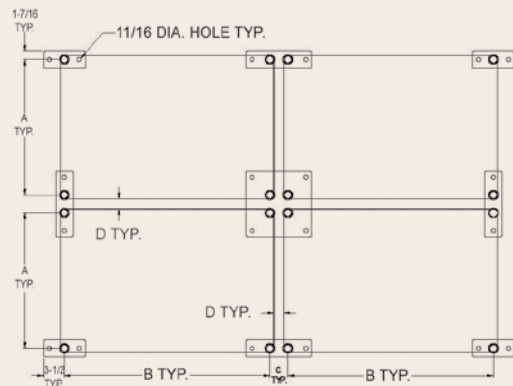

For the latest seismic information visit metro.com/seismic

Super Adjustable® Super Erecta, Super Erecta®, qwikSLOT®

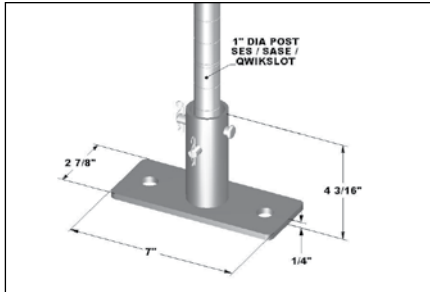

SASES25BP-1

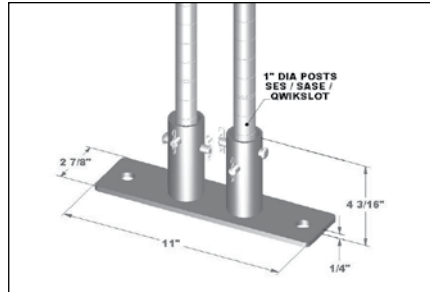

SASES25BP-2

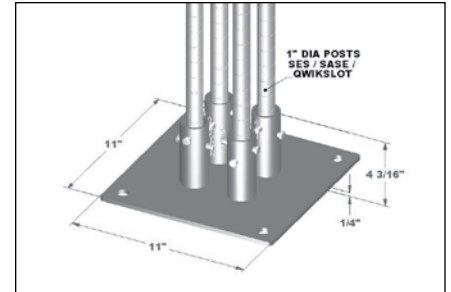

SASES25BP-4

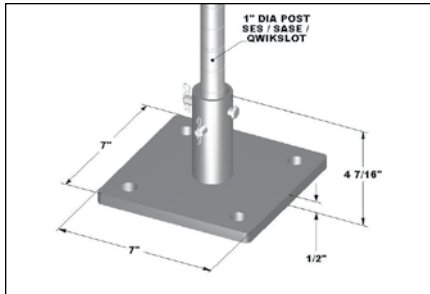

SASES50BP-1

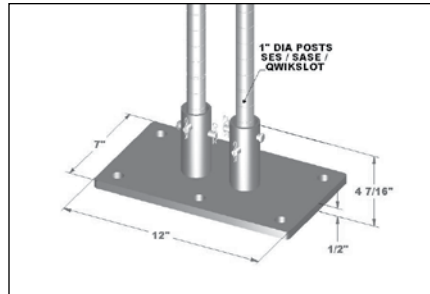

SASES50BP-2

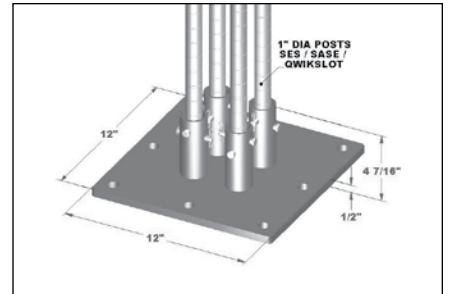

SASES50BP-4

Hint: It is recommended that a donut bumper be specified to cover any spaces between the post and the bolt plate anchor pipe. Specify the donut bumper to match the post type.

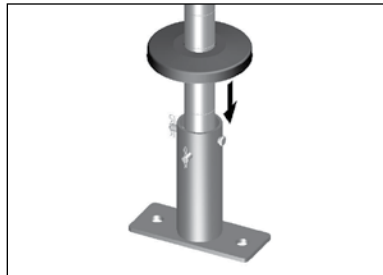

Super Erecta, Super Adjustable Super Erecta, qwikSLOT = 9992DB
 Super Erecta Shelf HD = 9992H
 MetroMax Q = 9992DBX

MetroMax® Q/HD Super

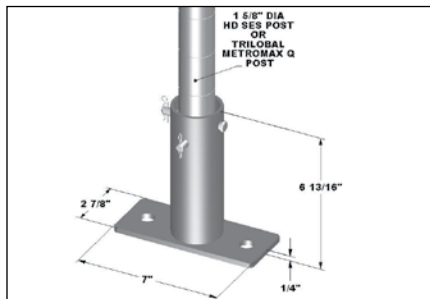

SAQHDS25BP-1

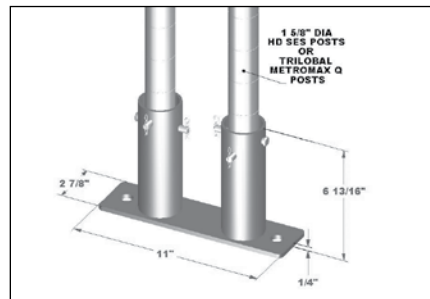

SAQHD25BP-2

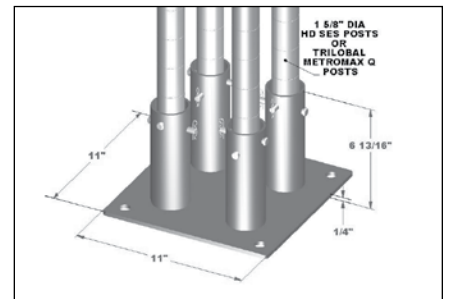

SAQHD25BP-4

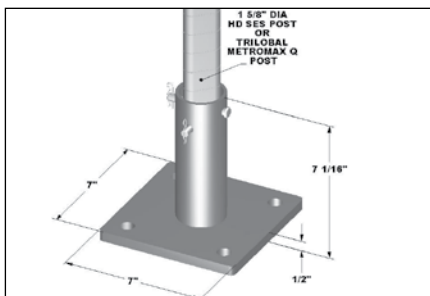

SAQHD50BP-1

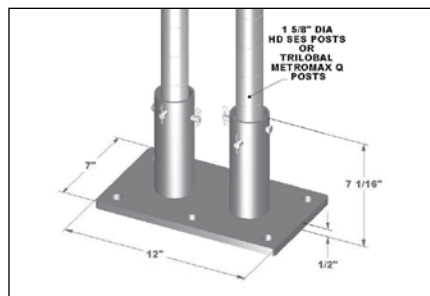

SAQHD50BP-2

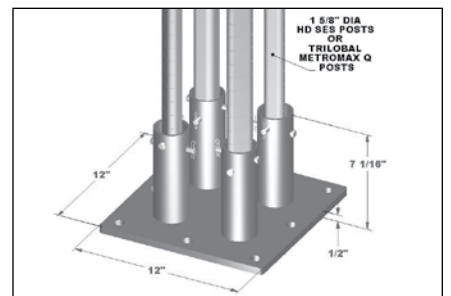

SAQHD50BP-4



**Move,
store &
secure
what
matters
most.**

myCart Series®
myFold™
Deep Ledge

UTILITY CARTS, DUNNAGE & SECURITY

Polymer Utility Carts	124-127
Wire & Solid Utility Carts	128-129
Dunnage Racks & Shelves	130-131
Security Storage.....	132-137

It's myCart, get your own.



PROTECTION THAT LIVES ON
MICROBAN



Better Containment!

Ship's edge retains small spills and prevents items from sliding off during transport.



Make it yours.



myCart

Utility Cart

Easy & Useful

Easy-grip handle and roomy utility tray

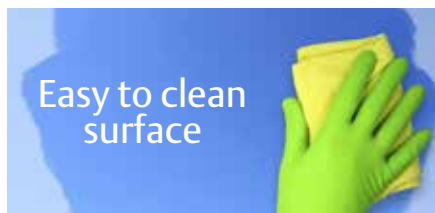

Easy to clean surface

Corrosion proof & impact resistant polymer shelves.



50% more legroom

You won't hit your shins or kick the cart!

Cleanable

- > NSF Listed.
- > Smooth surfaces easily wipe clean and won't stain.
- > Specific models available with Microban® Antimicrobial product protection.

Durable

- > Corrosion proof, impact resistant shelves are designed to withstand daily abuse.
- > Sturdy construction: 300lb. (136kg), 400lb. (181kg), and 500lb. (227kg) capacity models available.

User Friendly

- > Additional legroom puts more distance between the shelves and you. You can push the cart more freely without hitting your shins and feet off the cart.
- > Right-sized for common containers and racks.
- > Large covered utility tray organizes small items and easily wipes clean.
- > Easy-grip handle and four swivel casters ensure easy maneuvering.
- > Each cart comes with two personalization labels for easy identification.



Foodservice

Allergen Free Zone myCart! Help control cross-contact and protect your customers by using this cart to prep/transport food for allergen sensitive customers.

Healthcare

A unique color to help distinguish specific products or applications. A cool color with nurturing qualities for departments like pediatrics, labor and delivery.

Grocery

Ideal for storing and transporting items that are required to be kept separate from other items, such as organics.

myCart Series® — {12.29}

- > Available in 2-shelf and 3-shelf configurations.
- > 7¹/₁₆" (11mm) deep ship's edge lip around shelf perimeter.
- > MY1627 and MY2030 Base Model specs: Chrome posts, 4" (102mm) non-marking swivel casters. 150 lbs. (68kg) capacity per shelf.
- > MY2636 Base Model specs: Chrome posts, 5" (127mm) swivel resilient rubber casters, 200 lbs. (90kg) capacity per shelf.



Carts

Width/Length/Height (in.)	Width/Length/Height (mm)	Description	Load Rating Per Cart (lbs.) (kg)	Approx. Pkd. Wt. (lbs.) (kg)	Cat. No. Gray	Cat. No. Black	Cat. No. Blue with Antimicrobial	Cat. No. Purple
18 ⁵ / ₁₆ x31 ¹ / ₂ x35 ¹ / ₂	465x800x902	2-shelf base model	300 136	28.5 12.9	MY1627-24G	MY1627-24BL	MY1627-24BU	—
18 ⁵ / ₁₆ x31 ¹ / ₂ x35 ¹ / ₂	465x800x902	3-shelf base model	400 181	34 15.4	MY1627-34G	MY1627-34BL	MY1627-34BU	—
23 ⁷ / ₁₆ x34 ³ / ₈ x35 ¹ / ₂	595x873x902	2-shelf base model	300 136	33 15	MY2030-24G	MY2030-24BL	MY2030-24BU	MY2030-24AP
23 ⁷ / ₁₆ x34 ³ / ₈ x35 ¹ / ₂	595x873x902	3-shelf base model	400 181	41.5 19	MY2030-34G	MY2030-34BL	MY2030-34BU	MY2030-34AP
27 ¹ / ₁₆ x40 ¹ / ₄ x36 ⁷ / ₈	703x1022x937	2-shelf base model	400 181	40 18.1	MY2636-25G	MY2636-25BL	MY2636-25BU	—
27 ¹ / ₁₆ x40 ¹ / ₄ x36 ⁷ / ₈	703x1022x937	3-shelf base model	500 227	51 23.1	MY2636-35G	MY2636-35BL	MY2636-35BU	—

Accessories

- > Utility bin and wastebasket can be easily removed from their holders to empty contents or for routine cleaning.

Width/Height/Depth (in.)	Width/Height/Depth (mm)	Description	Fits Cart	Load Rating (lbs.) (kg)	Approx. Pkd. Wt (lbs.) (kg)	Cat. No.
17 ⁷ / ₈ x16 ¹ / ₂ x14 ³ / ₄	454x413x375	Wastebasket + Holder	MY1627	25 11.3	5.7 2.5	MYWB1
23x16 ¹ / ₂ x14 ³ / ₄	584x413x375	Wastebasket + Holder	MY2030	25 11.3	5.8 2.6	MYWB2
14 ³ / ₈ x15 ³ / ₈ x10 ³ / ₈	365x391x264	Wastebasket Only			2.8 1.3	MF222
17 ³ / ₈ x7x15 ¹ / ₄	454x178x387	Utility Bin + Holder	MY1627	25 11.3	5 2.2	MYUB1
23x7x15 ¹ / ₄	584x178x387	Utility Bin + Holder	MY2030	25 11.3	5.1 2.3	MYUB2
16 ³ / ₈ x6x11	416x152x279	Utility Bin Only			2 0.9	UB1



Wastebasket and Holder



Utility Bin and Holder

Personalization Labels

Personalization labels provide easy identification
 > Constructed of polyester material with a clear polyester flap to protect written information from wiping off.
 4³/₈"L x 7⁷/₈"H (117.5x22.4mm)
 Cat. No. MYCARTLBL-10PK Pack of 10

Replacement Casters

4" (102mm) non-marking swivel caster. Used with MY1627 and MY2030 models.
 Cat. No. RPBC4M-4 Bag of 4
 5" (127mm) swivel resilient rubber caster. Used with MY2636 models.
 Cat. No. 5M, sold individually.



MY1627

Easy-grip handle and utility tray

- > Small footprint for tight spaces.
- > Accommodates Metro tote boxes and ISO totes.



MY2030

MY2030 cart handle has built-in recessed support channel to manage odd shaped items.

- > Right-sized to fit : Glass & dish racks, bussing totes, silverware bins, milk crates.



MY2636

MY2636 cart handle has a built-in slot to hold scanners and labelers.

- > Ideal for large bulky items. 5" (127mm) Caster makes cart easier to maneuver. 3-shelf model holds up to 500 lbs.

☑ Indicates antimicrobial product.

My cart folds... does yours?



fold.

unfold.

myFold

Utility Cart

myFold Utility Cart — {12.27}

- > One hand folding to 8" (203mm) wide 41" (1041mm) tall for easy storage
- > Ships fully assembled
- > Base Model specs: 3 polymer shelves, Stainless steel posts, 4" (102mm) non-marking swivel casters (2) with brake.
- > Holds 117 lbs. (53kg) per shelf. 350 lbs. (159kg) total capacity

Width/Length/Height		Description	Approx. Pkd. Wt.		Cat. No.
(in.)	(mm)		(lbs.)	(kg)	
16.5x28.9x35.8	420x735x910	3-shelf folding cart	32.4	15.5	FC1627-34BL



Fold it.

Pack it up and take it with you. Perfect for off-site locations or storing in tight spaces.

Move it.

350lb. Total Cart Capacity. 2-Swivel and 2-Swivel/Brake non-marking casters. Easy grip handles on both sides.

Deep Ledge Utility Carts — {12.28} NSF

Specially designed with a 2³/₄" (70mm) deep ledge to contain product and spills.

- Polymer shelves are easy to clean and corrosion proof.
- Available colors are gray, black, and blue. Blue contains Microban antimicrobial product protection.
- Available in 2-shelf and 3-shelf models.
- Center shelf option adjusts at 1" (25mm) increments.



Width/Length/Height (in.) (mm)		Description	Approx. Pkd. Wt. (lbs.) (kg)		Cat. No.*	Cat. No. Slate Blue with Microban
21 ¹ / ₂ x33 ³ / ₄ x33 ¹ / ₄	546x857x845	2-shelf unit	29	31.1	BC2030-2D	BC2030-2DMB
21 ¹ / ₂ x33 ³ / ₄ x33 ¹ / ₄	546x857x845	3-shelf unit	37 ¹ / ₂	17.0	BC2030-3D	BC2030-3DMB
27x39 ¹ / ₂ x33 ¹ / ₄	685x1003x845	2-shelf unit	35	15.9	BC2636-2D	BC2636-2DMB
27x39 ¹ / ₂ x33 ¹ / ₄	685x1003x845	3-shelf unit	46 ¹ / ₂	21.1	BC2636-3D	BC2636-3DMB

*Add color designation to part number when ordering: Gray (G), Black (BL). Example: BC2030-3DG = 3-shelf gray cart.

Weight load capacity for Deep Ledge series.
150 lbs. (68kg) per shelf.
2-shelf model: 300 lbs. (136kg)
3-shelf model: 400 lbs. (181kg)

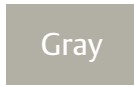

Accessories and Replacement Casters — {12.28}

- Utility Bin and Wastebasket can be easily removed from the holders to empty contents or for routine cleaning.

Description	Fits Cart	Width/Height/Depth (in.) (mm)		Approx. Pkd. Wt. (lbs.) (kg)		Deep Ledge Cat. No.
Wastebasket + Holder	BC2030	21 ¹ / ₄ x27 ¹ / ₂ x13 ¹ / ₄	540x700x337	8.0	3.8	BCWB2D
Utility Bin + Holder	BC2030	21 ¹ / ₄ x7 ³ / ₄ x14 ¹ / ₂	540x197x368	6.0	2.7	BCUB2D
Wastebasket Only		14 ³ / ₈ x15 ³ / ₈ x10 ³ / ₈	365x391x264	2.8	1.3	MF222
Utility Bin Only		16 ³ / ₈ x6x11	416x152x279	2.0	0.9	UB1
Replacement Caster Kit — All						RPBC4M-4

Note: Caster kit contains four 4" (102mm) swivel casters.



Basket Cart NSF

Includes two light-duty basket style shelves, one standard wire shelf, four posts, extended handle, and four 4" diameter swivel casters (two with brakes)

- Basket shelves have a 3¹/₂" (89mm) high edge to secure contents during transport.
- Durable chrome finish
- 400 lbs. (182kg) capacity per cart; 150 lbs. (68kg) capacity per shelf
- Ships in one box



* Cart comes in white point-of-sale box

Shelf Width/Length (in.) (mm)		Overall Length (including handle) (in.) (mm)		Overall Height (in.) (mm)		Approx. Pkd. Wt. (lbs.) (kg)	Cat. No.
18x36	457x914	39 ⁷ / ₈	1013	40 ⁷ / ₈	1020	49 22	BASCART-SR



MW200 Series

MW Series Utility Carts — {12.01}{12.05} NSF

- Consist of Super Erecta wire shelves with plastic split sleeves, two one-piece handles of matching finish, and designated casters with donut bumpers.
- Two- and three-tier models available.
- 375 lbs. (170kg) weight capacity per cart. MW carts use light-duty resilient casters.
- 18" (457mm) wide carts have 4" (102mm) casters. Cart is 38" (965mm) high.
- 21" and 24" (530 and 610mm) wide carts have 5" (127mm) casters. Cart is 39" (990mm) high.

Utility Carts with Stainless Steel Solid Shelves

Width/Length (in.) (mm)		Approx. Pkd. Wt. (lbs.) (kg)		Cat. No. 2-Shelf	Approx. Pkd. Wt. (lbs.) (kg)		Cat. No. 3-Shelf
18x24	457x610	40	18.1	MW103	48	21.8	MW203
18x30	457x760	45	20.4	MW104	53	24.0	MW204
18x36	457x914	48	21.8	MW105	59	26.8	MW205
21x36	530x914	54	24.5	MW106	74	33.6	MW206
24x36	610x914	60	27.2	MW108	66	29.9	MW208



MW400 Series

Utility Carts with 1 Solid, 2 Wire Shelves

Width/Length (in.) (mm)		Approx. Pkd. Wt. (lbs.) (kg)		Shelf Material	Handles	Cat. No.
18x24	457x610	43	19.5	Stainless Steel, Chrome	Chrome	MW401
18x30	457x760	47	21.3	Stainless Steel, Chrome	Chrome	MW402
18x36	457x914	52	23.6	Stainless Steel, Chrome	Chrome	MW403
21x36	530x914	59	26.8	Stainless Steel, Chrome	Chrome	MW404
24x36	610x914	65	29.5	Stainless Steel, Chrome	Chrome	MW406



MW600 Series

Utility Carts with 2 Wire Shelves

Width/Length (in.) (mm)		Approx. Pkd. Wt. (lbs.) (kg)		Shelf Material	Handles	Cat. No.
18x24	457x610	34	15.4	Chrome	Chrome	MW601
18x24	457x610	34	15.4	Stainless Steel	Stainless Steel	MW602
18x30	457x760	37	16.8	Chrome	Chrome	MW603
18x30	457x760	37	16.8	Stainless Steel	Stainless Steel	MW604
18x36	457x914	40	18.1	Chrome	Chrome	MW605
18x36	457x914	39	17.7	Stainless Steel	Stainless Steel	MW606
21x36	530x914	44	20.0	Chrome	Chrome	MW607
21x36	530x914	44	20.0	Stainless Steel	Stainless Steel	MW608
24x36	610x914	47	21.3	Chrome	Chrome	MW611
24x36	610x914	46	20.9	Stainless Steel	Stainless Steel	MW612



MW700 Series

Utility Carts with 3 Wire Shelves

Width/Length (in.) (mm)		Approx. Pkd. Wt. (lbs.) (kg)		Shelf Material	Handles	Cat. No.
18x24	457x610	39	17.6	Chrome	Chrome	MW701
18x24	457x610	38	17.2	Stainless Steel	Stainless Steel	MW702
18x30	457x760	43	19.5	Chrome	Chrome	MW703
18x30	457x760	42	19.1	Stainless Steel	Stainless Steel	MW704
18x36	457x914	47	21.3	Chrome	Chrome	MW705
18x36	457x914	45	20.4	Stainless Steel	Stainless Steel	MW706
21x36	530x914	50	22.7	Chrome	Chrome	MW707
21x36	530x914	50	22.7	Stainless Steel	Stainless Steel	MW708
24x36	610x914	60	27.7	Chrome	Chrome	MW711
24x36	610x914	57	25.9	Stainless Steel	Stainless Steel	MW712

SP Series Utility Carts — {12.10}

- Consist of Super Erecta wire shelves with plastic split sleeves, two one-piece handles of matching finish, and designated casters with donut bumpers.
- Two- and three-tier models available.
- 5" (127mm) casters allow for transport of heavier loads than the MW Series Carts.
- 39" (990mm) high.



2-Tier with 5M casters

Super Erecta Brite finish — 600 lbs. (273kg) capacity per cart

- 5M Resilient Rubber Casters; casters have plated horns and axles.

Shelf Width/Length (in.) (mm)	2-TIER MODELS		3-TIER MODELS	
	Approx. Pkd. Wt. (lbs.) (kg)	Cat. No. Super Erecta Brite	Approx. Pkd. Wt. (lbs.) (kg)	Cat. No. Super Erecta Brite
18x36 457x914	40 18	2SPN33ABR	50 22.5	3SPN33ABR
21x36 530x914	44 20	2SPN43ABR	55 24.7	3SPN43ABR
24x36 610x914	48 22	2SPN53ABR	61 27.4	3SPN53ABR
24x48 610x1219	54 24	2SPN55ABR	70 31.5	3SPN55ABR
24x60 610x1524	64 29	2SPN56ABR	85 38.2	3SPN56ABR



3-Tier with 5MP casters

Chrome finish — 900 lbs. (410kg) capacity per cart

- 5MP Polyurethane Casters; casters have plated horns and axles.

Shelf Width/Length (in.) (mm)	2-TIER MODELS		3-TIER MODELS	
	Approx. Pkd. Wt. (lbs.) (kg)	Cat. No. Chrome	Approx. Pkd. Wt. (lbs.) (kg)	Cat. No. Chrome
18x36 457x914	40 18	2SPN33DC	50 22.5	3SPN33DC
21x36 530x914	44 20	2SPN43DC	55 24.7	3SPN43DC
24x36 610x914	48 22	2SPN53DC	61 27.4	3SPN53DC
24x48 610x1219	54 24	2SPN55DC	70 31.5	3SPN55DC
24x60 610x1524	64 29	2SPN56DC	85 38.2	3SPN56DC

Type 304 Stainless Steel — 900 lbs. (410kg) capacity per cart

- 5PC Polyurethane Casters; casters have polymer horns and stainless steel axles.

Shelf Width/Length (in.) (mm)	2-TIER MODELS		3-TIER MODELS	
	Approx. Pkd. Wt. (lbs.) (kg)	Cat. No. Stainless Steel	Approx. Pkd. Wt. (lbs.) (kg)	Cat. No. Stainless Steel
18x36 457x914	40 18	2SPN33PS	50 22.5	3SPN33PS
21x36 530x914	44 20	2SPN43PS	55 24.7	3SPN43PS
24x36 610x914	48 22	2SPN53PS	61 27.4	3SPN53PS
24x48 610x1219	54 24	2SPN55PS	70 31.5	3SPN55PS
24x60 610x1524	64 29	2SPN56PS	85 38.2	3SPN56PS



3-Tier with 5PC casters

One-Piece Handles — {12.10}

May be used with Super Erecta shelving, casters, and components to customize a cart to your exact needs.

Shelf Width/Length (in.) (mm)	Approx. Pkd. Wt. (lbs.) (kg)	Cat. No. Chrome	Cat. No. Stainless Steel
18 457	5 1/2 2.5	H3C	H3S
21 533	5 3/4 2.6	H4C	H4S
24 610	6 2.7	H5C	H5S

Height: 34 1/2" (876mm).



One-Piece Handle



Off-the-floor efficiency.



Bow-Tie Dunnage Rack

Bow-Tie™ Dunnage Racks — {9.09}

12" (305mm) high; 22" (559mm) wide.

- Metro Bow-Tie Dunnage Racks are available with built-in Microban® antimicrobial product protection to protect from bacteria, mold, mildew and fungi that cause odors, stains and product degradation. Standard models, without Microban, are also available.
- Rust and corrosion-proof polymer material.
- Helps protect floors: legs have a larger radius than traditional dunnage racks and distribute the storage load across a wider area.
- Racks join together easily without tools in “end-to-end” and “back-to-back” configurations with the exclusive Bow-Tie™ feature.
- Heavy-duty construction gives racks the strength to hold up to 1,500 lbs. (683kg) for 30" (760mm) and 36" (914mm) long racks, and 3,000 (1365kg) for 48" (1219mm) and 60" (1524mm) racks.

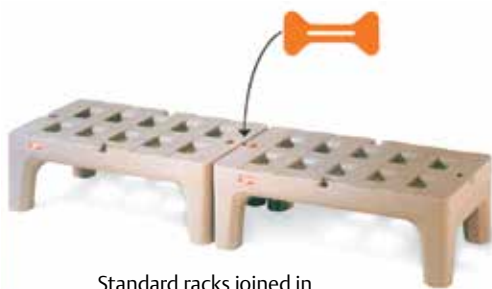

Standard racks joined in “end-to-end” configuration.

Length		Height		Approx. Pkd. Wt.		Capacity		Cat. No. Microban®	Cat. No. Standard
(in.)	(mm)	(in.)	(mm)	(lbs.)	(kg)	(lbs.)	(kg)		
30	760	12	305	24	10.8	1500	68	HP2230PDMB	HP2230PD
36	914	12	305	26	11.7	1500	68	HP2236PDMB	HP2236PD
48	1219	12	305	34	15.3	3000	136	HP2248PDMB	HP2248PD
60	1524	12	305	42	19	3000	136	HP2260PDMB	HP2260PD

Indicates antimicrobial product.

Dunnage Platforms (Standard Duty) — {10.44}

Space-saving platforms let you keep bulky items off the floor.

- Open wire provides air circulation and minimizes dust.
- All platforms use 13P or 13PS posts — height 14⁵/₈" (371mm) including cap and leveling bolt.

Width/Length (in.)	Width/Length (mm)	Approx. Pkd. Wt. (lbs.)	Approx. Pkd. Wt. (kg)	Cat. No. Super Erecta Brite	Cat. No. Chrome	Cat. No. Stainless
18x24	457x610	11	5.0	P1824BR	P1824NC	P1824NS
18x30	457x760	12	5.5	P1830BR	P1830NC	P1830NS
18x36	457x914	13 ¹ / ₂	6.1	P1836BR	P1836NC	P1836NS
21x24	530x610	12	5.5	P2124BR	P2124NC	P2124NS
21x30	530x760	13	5.9	P2130BR	P2130NC	P2130NS
21x36	530x914	15	6.8	P2136BR	P2136NC	P2136NS
24x24	610x610	13	5.9	P2424BR	P2424NC	P2424NS
24x30	610x760	15	6.8	P2430BR	P2430NC	P2430NS
24x36	610x914	17	7.7	P2436BR	P2436NC	P2436NS

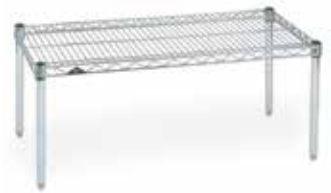

Super Erecta Platform

Heavy-Duty Dunnage Racks — {10.46}

A space-efficient way to store large, bulky items off the floor.

- Removable top mat lifts off for cleaning.
- Dunnage racks are 14¹/₂" (368mm) high including mat, cap and leveling bolt.

Width/Length (in.)	Width/Length (mm)	Approx. Pkd. Wt. (lbs.)	Approx. Pkd. Wt. (kg)	Cat. No. Chrome	Cat. No. Metroseal 3 with Microban®	Cat. No. Stainless
18x24	457x610	22	10	HP31C	HP31K3	
18x30	457x760	25	11	HP32C	HP32K3	
18x36	457x914	30	13	HP33C	HP33K3	HP33S
18x48	457x1219	38	17	HP35C*	HP35K3*	HP35S*
24x24	610x610	28	12	HP51C	HP51K3	
24x30	610x760	30	14	HP52C	HP52K3	
24x36	610x914	36	16	HP53C	HP53K3	HP53S
24x48	610x1219	42	19	HP55C*	HP55K3*	HP55S*



Dunnage Rack with Mat

Note: Maximum distributed static load capacity for stationary dunnage racks is 1,600 lbs. (725kg), except on units marked * which have a 1,300 lb. (590kg) capacity.

Mobile Dunnage Racks (Heavy Duty) — {10.46}

These easy-to-manuever racks feature two swivel and two swivel/brake casters; with non-marking polyurethane tread.

- Support frames: 1" (25mm) square tubing.
- Removable wire mat: 5/16" (7.9mm) diameter wire.

Width/Length (in.)	Width/Length (mm)	Approx. Pkd. Wt. (lbs.)	Approx. Pkd. Wt. (kg)	Cat. No. Chrome	Cat. No. Metroseal 3 with Microban®	Cat. No. Stainless
18x36	457x914	42	18.9	MHP33C	MHP33K3	MHP33S
18x48	457x1219	50	22.5	MHP35C	MHP35K3	MHP35S
24x36	610x914	48	21.6	MHP53C	MHP53K3	MHP53S
24x48	610x1219	54	24.3	MHP55C	MHP55K3	MHP55S



Mobile Dunnage Rack shown in Metroseal 3 finish

Maximum distributed static load capacity is 800 lbs. (363kg).

Note: These units are designed for only the 5HP and 5HPB casters, which are shipped assembled with the special posts.

HD Super Duty Dunnage Racks — {10.68}

Stores more than a ton safely off the floor.

- 48" (1219mm) rack has a 3,000 pound (1361kg) static load capacity (uniformly distributed); 60" (1524mm) rack carries up to 2,400 pounds (1089kg).
- HD Super™ design features fast, secure assembly without tools.
- Posts of 1⁵/₈" (41mm) diameter provide greater rigidity.
- HD Super™ Dunnage Racks are 16¹/₄" (413mm) high including cap and leveling bolt.

Width/Length (in.)	Width/Length (mm)	Approx. Pkd. Wt. (lbs.)	Approx. Pkd. Wt. (kg)	Cat. No. Chrome	Cat. No. Metroseal 3 with Microban®	Cat. No. Stainless
18x48	457x1219	52	23.4	HDP35C	HDP35K3	HDP35S
18x60	457x1524	62	27.9	HDP36C	HDP36K3	HDP36S
24x48	610x1219	57	26.6	HDP55C	HDP55K3	HDP55S
24x60	610x1524	66	29.7	HDP56C	HDP56K3	HDP56S



HD Super Dunnage Rack

Maximum capacity 2,400 pounds (1089kg) uniformly distributed static load on the 60" (1524mm) length racks; 3,000 pounds (1361kg) on the 48" (1219mm) length racks.

Note: Capacity will be reduced and the unit will become less stable if the 3-sided frame is mounted higher than 6" (152mm) from the floor.



Indicates antimicrobial product.

Keep'em out!

Protect Valuables.

Keep sensitive items from loss or pilferage.

Visible, yet Safe.

Ready View of Contents: Heavy-gauge open wire construction keeps contents visible at all times, making it easy to check inventory.

Security Units — {14.01}

- Optional Adjustable Intermediate Shelves: Patented easily adjustable shelf designs — Super Adjustable Super Erecta, MetroMax Q, and quikSLOT — allow flexibility to meet changing needs. Can be positioned in 1" (25mm) increments along the entire height of post.
- Double Door: Each door opens 270 degrees and can be secured along the sides of the unit.
- Shipped Knocked-Down: Saves on freight costs. Easily assembled.















MetroMax Q Security Unit



Super Adjustable Super Erecta Security Unit

Ordering Guide for Security Units

	Dry Environments		Wet Environments		
<p>FIRST Choose the right finish & shelving style based upon usage and environment and/or cleaning methods.</p>	 <p>Super Erecta Chrome Finish</p>	 <p>qwikSLOT Chrome Finish</p>	 <p>Super Erecta Metroseal 3 Finish</p>	 <p>MetroMax Q Rust Resistant Polymer & Coated Wire</p>	 <p>Super Erecta Type 304 Stainless Steel Finish</p>
Corrosion Protection >	-	-	Corrosion Resistant	Corrosion Resistant	Corrosion Proof
NSF listed >	YES	NO	YES	YES	YES
<p>NEXT Choose from stationary and mobile options.</p>					
Stationary >	8 Models	5 Models	5 Models	3 Models	3 Models
<p>Mobile ></p> <p>Medium-Duty Recommended security models with stem casters</p>	 <p>DC & EC Models Include Casters with zinc-plated horns</p>	 <p>DC & EC Models Include Casters with zinc-plated horns</p>	 <p>VK3 Models Include Casters with polymer horns</p>	 <p>VE Models Include Casters with polymer horns</p>	<p>SD Models Casters are not provided with stainless Steel Standard Duty Stem Caster base models. Casters are sold separately.</p>
<p>Mobile ></p> <p>Heavy-Duty Best addressed with dolly bases. Recommended when cart will be frequently moved over long distances, between facilities, over thresholds. Super Erecta units best fit this application.</p>	 <p>LC Models Dollies/casters included.</p>	 <p>LCQ Models Dollies/casters included.</p>	 <p>LK3 Models Dollies/casters included.</p>	 <p>LE Models Dollies/casters included.</p>	<p>S-HD Models Dollies and plate casters are NOT provided with the heavy-duty stainless steel base models. Dollies and plate casters are sold separately.</p>
<p>LAST Select Intermediate shelves. Shelves are not included with base models.</p>					



SEC55C shown with optional Super Adjustable intermediate shelves.

Super Erecta® Shelf Stationary Security — {14.01}

66¹³/₁₆" (1695mm) high

Intermediate shelves are not included with base models and must be ordered separately. See page 105 for intermediate shelf options.

Width (in.)	Length (mm)	Fits Shelf (in.)	Approx. Pkd. Wt. (lbs.)	Cat. No. Chrome	Cat. No. Metroseal 3 with Microban®	Cat. No. Stainless Steel
21 ¹ / ₂	546	38 ¹ / ₂ 980	138 63	SEC33C	SEC33K3	SEC33S
21 ¹ / ₂	546	50 ¹ / ₂ 1295	157 71	SEC35C	SEC35K3	SEC35S
27 ¹ / ₄	692	38 ¹ / ₂ 980	154 70	SEC53C	SEC53K3	SEC53S
27 ¹ / ₄	692	50 ¹ / ₂ 1295	174 79	SEC55C	SEC55K3	SEC55S
27 ¹ / ₄	692	62 ¹ / ₂ 1587	195 89	SEC56C	SEC56K3	SEC56S
33 ¹ / ₂	851	38 ¹ / ₂ 980	167 76	SEC63C		SEC63S
33 ¹ / ₂	851	50 ¹ / ₂ 1295	193 88	SEC65C		SEC65S
33 ¹ / ₂	851	62 ¹ / ₂ 1587	215 98	SEC66C		SEC66S



SEC55DC shown with optional Super Adjustable intermediate shelves (sold separately). Doors rotate 270° and can be secured to the sides of the cart while contents are being loaded on the shelves.

Super Erecta® Mobile Security — {14.01}

Standard-Duty Stem Caster Models — Chrome and Metroseal 3

Chrome and Metroseal 3 Standard-Duty Stem Caster Models include 5" (127mm) casters.

Intermediate shelves are not included with base models and must be ordered separately. See page 137 for intermediate shelf options.

Caster Type	Width (in.)	Length (mm)	Fits Shelf (in.)	Approx. Pkd. Wt. (lbs.)	Cat. No. Chrome	Cat. No. Metroseal 3 with Microban®
(2) 5MP/(2) 5MPB	21 ¹ / ₂	546	40 ³ / ₄ 1035	146 66	SEC33EC	SEC33EK3
(2) 5MP/(2) 5MPB	21 ¹ / ₂	546	52 ³ / ₄ 1340	165 75	SEC35EC	SEC35EK3
(4) 5MP	27 ¹ / ₄	692	40 ³ / ₄ 1035	162 74	SEC53DC	SEC53DK3
(4) 5MP	27 ¹ / ₄	692	52 ³ / ₄ 1340	182 83	SEC55DC	SEC55DK3
(4) 5MP	27 ¹ / ₄	692	65 1651	203 92	SEC56DC	SEC56DK3
(2) 5MP/5MPB	27 ¹ / ₄	692	40 ³ / ₄ 1035	162 74	SEC53EC	SEC53EK3
(2) 5MP/5MPB	27 ¹ / ₄	692	52 ³ / ₄ 1340	182 83	SEC55EC	SEC55EK3
(2) 5MP/5MPB	27 ¹ / ₄	692	65 1651	203 92	SEC56EC	SEC56EK3
(2) 5PC/5PCB	27 ¹ / ₄	692	40 ³ / ₄ 1035	162 74	SEC53VK3	SEC53VK3
(2) 5PC/5PCB	27 ¹ / ₄	692	52 ³ / ₄ 1340	182 83	SEC55VK3	SEC55VK3
(2) 5PC/5PCB	27 ¹ / ₄	692	65 1651	203 92	SEC56VK3	SEC56VK3
(2) 5MP/(2) 5MPB	33 ¹ / ₂	851	40 ³ / ₄ 1035	175 80	SEC63EC	
(2) 5MP/(2) 5MPB	33 ¹ / ₂	851	52 ³ / ₄ 1340	202 92	SEC65EC	
(2) 5MP/(2) 5MPB	33 ¹ / ₂	851	65 1651	223 101	SEC66EC	

Casters: 5MP and 5MPB (with locking brake) feature a polyurethane tread. 5PC and 5PCB (with locking brake) casters feature a polymer horn and resist rusting. They are recommended for high moisture environments. Large casters can create a tipping hazard. On security units using 18" (457mm) deep shelving, do not use casters larger than 5" (127mm) in diameter. Overall height: Models with 5MP casters — 67¹⁵/₁₆" (1726mm) high. Models with 5PC casters — 68⁷/₁₆" (1739mm) high.



SEC55LC shown with optional Super Adjustable intermediate shelves.

Heavy-Duty Models — Chrome and Metroseal 3 — {14.01}

68⁷/₁₆" (1739mm) high

Chrome and Metroseal 3 models feature aluminum dollies with wraparound bumpers and 5" (127mm) diameter casters.

Caster Type	Width (in.)	Length (mm)	Fits Shelf (in.)	Approx. Pkd. Wt. (lbs.)	Cat. No. Chrome	Cat. No. Metroseal 3 with Microban®
(2) B5P/B5PB	28 ¹ / ₁₆	713	38 ¹ / ₂ 980	187 85	SEC53LC	SEC53LK3
(2) B5P/B5PB	28 ¹ / ₁₆	713	50 ¹ / ₂ 1285	210 95	SEC55LC	SEC55LK3
(2) B5P/B5PB	28 ¹ / ₁₆	713	63 ¹ / ₈ 1600	235 107	SEC56LC	SEC56LK3

NSF Note: Super Erecta Security Units are NSF listed.



Indicates antimicrobial product.

Standard-Duty Stem Caster Models — Stainless Steel — {14.01}

62" (1575mm) high

Casters must be ordered separately. See pages 50-51, or consult your Metro representative for the proper caster for your application. Intermediate shelves are not included with base models and must be ordered separately.

Description	Width (in.) (mm)	Length (in.) (mm)	Fits Shelf (in.) (mm)	Approx. Pkd. Wt. (lbs.) (kg)	Cat. No. Stainless Steel
Standard Duty	21 ¹ / ₂ 546	40 ³ / ₄ 1035	18x36 457x914	138 63	SEC33S-SD
Standard Duty	21 ¹ / ₂ 546	52 ³ / ₄ 1340	18x48 457x1219	157 71	SEC35S-SD
Standard Duty	27 ¹ / ₄ 692	40 ³ / ₄ 1035	24x36 610x914	154 70	SEC53S-SD
Standard Duty	27 ¹ / ₄ 692	52 ³ / ₄ 1340	24x48 610x1219	174 79	SEC55S-SD
Standard Duty	27 ¹ / ₄ 692	65 1651	24x60 610x1524	195 89	SEC56S-SD
Standard Duty	33 ¹ / ₂ 851	40 ³ / ₄ 1035	30x36 760x914	167 76	SEC63S-SD
Standard Duty	33 ¹ / ₂ 851	52 ³ / ₄ 1340	30x48 760x1219	193 88	SEC65S-SD
Standard Duty	33 ¹ / ₂ 851	65 1651	30x60 760x1524	215 98	SEC66S-SD

Note: Given height is for unit without casters. For approximate overall unit height add chosen caster diameter plus 1" (25mm).
Note: Large casters can create a tipping hazard. On security units using 18" (457mm) deep shelving, do not use casters larger than 5" (127mm) in diameter.

Heavy-Duty Models — Stainless Steel — {14.01}

62" (1575mm) high

Heavy-duty stainless steel models include staked posts for use with standard Metro dollies. Dolly bases and plate casters must be ordered separately. See pages 52-54, or consult your Metro representative for the proper caster for your application. Intermediate shelves are not included with base models and must be ordered separately.

Description	Width (in.) (mm)	Length (in.) (mm)	Fits Shelf (in.) (mm)	Approx. Pkd. Wt. (lbs.) (kg)	Cat. No. Stainless Steel
Heavy Duty	28 ¹ / ₁₆ 713	38 ¹ / ₂ 980	24x36 610x914	154 70	SEC53S-HD
Heavy Duty	28 ¹ / ₁₆ 713	50 ¹ / ₂ 1285	24x48 610x1219	174 79	SEC55S-HD
Heavy Duty	28 ¹ / ₁₆ 713	63 ⁷ / ₈ 1600	24x60 610x1524	195 89	SEC56S-HD

Note: Given height is for unit without a Metro dolly or casters.
Note: To calculate the actual height of the unit using plate casters: 62" [1575mm] + 1/4" [6mm] for dolly + load height of the caster (found on page 51).
 Dolly bases are recommended for applications where security units will be transported over the road. Please consult your Metro representative for the appropriate casters and accessories for these applications.

Intermediate Shelves for Super Erecta Shelf Security Units

Width (in.) (mm)	Length (in.) (mm)	Approx. Pkd. Wt. (lbs.) (kg)	Cat. No. Chrome	Cat. No. Metroseal 3 with Microban®	Cat. No. Stainless Steel	Cat. No. Super Erecta Pro
18 457	36 914	9 ¹ / ₂ 4.3	A1836NC	A1836NK3	A1836NS	PR1836NK3
18 457	48 1219	12 5.4	A1848NC	A1848NK3	A1848NS	PR1848NK3
24 610	36 914	13 6	A2436NC	A2436NK3	A2436NS	PR2436NK3
24 610	48 1219	16 7	A2448NC	A2448NK3	A2448NS	PR2448NK3
24 610	60 1524	21 9.5	A2460NC	A2460NK3	A2460NS	PR2460NK3
30 760	36 914	15 6.8	A3036NC		A3036NS	
30 760	48 1219	21 9.5	A3048NC		A3048NS	
30 760	60 1524	26 ¹ / ₂ 11.8	A3060NC		A3060NS	

Note: Standard Super Erecta shelves can also be used as intermediate shelves. Refer to page 42 for more information.

Super Erecta Security Modules — {14.01}

Convert a standard 24" (610mm) wide unit into a security module with this convenient kit.

- Used to enclose one or more areas of a unit.
- Fits between shelves spaced 20" (510mm) apart on any Super Erecta Shelving unit.
- Adapts to 24" (610mm) wide shelves in 30," 48" and 60" (760, 1219 and 1524mm) lengths.

Width/Length (in.) (mm)	Height (in.) (mm)	Approx. Pkd. Wt. (lbs.) (kg)	Cat. No. Chrome	Cat. No. Stainless Steel
24x30 610x760	20 510	29 ¹ / ₄ 14	SECM2430NC	SECM2430NS
24x48 610x1219	20 510	39 ³ / ₄ 18	SECM2448NC	*
24x60 610x1524	20 510	45 ³ / ₄ 21	SECM2460NC	*

Note: Security Module consists of side panels, back panels and door. Posts and shelves sold separately, see page 42.
When multiple security modules are stacked on one shelving unit, separate top and bottom shelves are still necessary for each module.
 Security modules must be used with Super Erecta Shelf wire shelves.
 *Consult your Metro representative for availability.

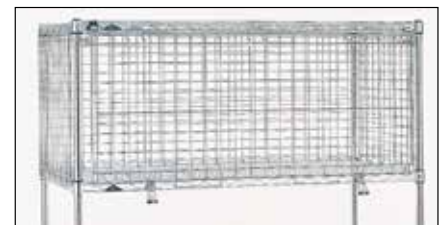

SECM2430NC
Assembled on Shelving Unit



Ⓜ Indicates antimicrobial product.



SEC53DCQ shown with Intermediate Shelves (optional)

qwikSLOT® Security Units — {14.01}

- Add/Remove-A-Shelf Feature: Allows the unit to quickly adapt to your changing storage needs.
- Shelves can be adjusted easily in seconds.
- Models include two standard Super Erecta shelves which must be used as the top and bottom shelves of the unit. qwikSLOT intermediate shelves are sold separately.

qwikSLOT Stationary Security

	Width		Actual Length		Height		Fits Shelf	Approx. Pkd. Wt.		Cat. No. Chrome	
	(in.)	(mm)	(in.)	(mm)	(in.)	(mm)		(lbs.)	(kg)		
	21½	546	38½	980	66 ¹³ / ₁₆	1695	18x36	457x914	138	63	SEC33CQ
	21½	546	50½	1283	66 ¹³ / ₁₆	1695	18x48	457x1219	157	71	SEC35CQ
	27¼	705	38½	980	66 ¹³ / ₁₆	1695	24x36	610x914	154	70	SEC53CQ
	27¼	705	50½	1283	66 ¹³ / ₁₆	1695	24x48	610x1219	174	79	SEC55CQ
	27¼	705	62½	1587	66 ¹³ / ₁₆	1695	24x60	610x1524	195	89	SEC56CQ

qwikSLOT Mobile Security

Standard-Duty Stem Caster Models: feature 5" (127mm) swivel casters. Please note model numbers for specific caster types.

Caster Type	Width		Actual Length		Height		Fits Shelf	Approx. Pkd. Wt.		Cat. No. Chrome	
	(in.)	(mm)	(in.)	(mm)	(in.)	(mm)		(lbs.)	(kg)		
(2) 5MP/5MPB	21½	546	40¾	1035	67 ¹⁵ / ₁₆	1726	18x36	457x914	146	66	SEC33ECQ
(2) 5MP/5MPB	21½	546	52¾	1340	67 ¹⁵ / ₁₆	1726	18x48	457x1219	165	75	SEC35ECQ
(4) 5MP	27¼	692	40¾	1035	67 ¹⁵ / ₁₆	1726	24x36	610x914	162	74	SEC53DCQ
(4) 5MP	27¼	692	52¾	1340	67 ¹⁵ / ₁₆	1726	24x48	610x1219	182	83	SEC55DCQ
(4) 5MP	27¼	692	65	1651	67 ¹⁵ / ₁₆	1726	24x60	610x1524	203	92	SEC56DCQ
(2) 5MP/5MPB	27¼	692	40¾	1035	67 ¹⁵ / ₁₆	1726	24x36	610x914	162	74	SEC53ECQ
(2) 5MP/5MPB	27¼	692	52¾	1340	67 ¹⁵ / ₁₆	1726	24x48	610x1219	182	83	SEC55ECQ
(2) 5MP/5MPB	27¼	692	65	1651	67 ¹⁵ / ₁₆	1726	24x60	610x1524	203	92	SEC56ECQ

Casters: 5MP and 5MPB (with locking brake) feature a polyurethane tread. 5PC and 5PCB (with locking brake) casters feature a polymer horn and resist rusting. They are recommended for high moisture environments.
NOTE: Large casters can create a tipping hazard. On 18" (457mm) security units, do not use casters larger than 5" (127mm) in diameter.



Clips snap easily into slots along post length to support shelves.

Heavy-Duty Models: feature aluminum dollies with wraparound bumpers and 5" (127mm) diameter casters.

Caster Type	Width		Actual Length		Height		Fits Shelf	Approx. Pkd. Wt.		Cat. No. Chrome	
	(in.)	(mm)	(in.)	(mm)	(in.)	(mm)		(lbs.)	(kg)		
(2) 5BP/5BPB	28 ¹ / ₁₆	713	38½	980	68 ⁷ / ₁₆	1739	24x36	610x914	187	85	SEC53LCQ
(2) 5BP/5BPB	28 ¹ / ₁₆	713	50½	1283	68 ⁷ / ₁₆	1739	24x48	610x1219	210	95	SEC55LCQ
(2) 5BP/5BPB	28 ¹ / ₁₆	713	63 ¹ / ₈	1600	68 ⁷ / ₁₆	1739	24x60	610x1524	235	107	SEC56LCQ

Intermediate Shelves for Super Erecta Shelf Security Units

Width	Length	Approx. Pkd. Wt.		Cat. No. Chrome
(in.)	(mm)	(in.)	(kg)	
18	457	8½	3.8	1836QBR
18	457	11¼	5.0	1848QBR*
24	610	13	6.0	2436QBR*
24	610	16	7.0	2448QBR*
24	610	21	9.5	2460QBR

*Chrome qwikSLOT shelves available in sizes 18x36, 18x48, 24x36, and 24x48 (457x914, 457x1219, 610x914, 610x1219, and 610x1524).

**Drop Mat qwikSLOT shelves with 1" (25mm) ledge also available in sizes 24x36, 24x48 (610x914, 610x1219).



qwikSLOT Locking Clip
 Recommended for mobile applications. Must be used with 9985QS shelf clips. (Package of 4)
 Cat. No. 9985QSL

MetroMax® Q

Security.

MetroMax Q Security Units — {14.01}

Protects valuable materials and sensitive items from loss or pilferage.

- Ready view of contents: Heavy gauge open wire construction keep contents visible at all times, making it easy to check inventory.
- Microban antimicrobial product protection is built into the enclosures, doors, handles, and shelves to keep the product “cleaner between cleanings.”
- Optional intermediate shelves: MetroMax Q quick adjust shelves or corrosion proof MetroMax i.
- Double door with ergonomic ¼-turn handle: Each door opens 270 degrees and can be secured along the sides of the unit.
- Shipped knocked down to save on freight costs. Assembles in minutes.



MQSEC53VE with optional intermediate shelves

Standard Units consist of top and bottom wire shelves, tri-lobal adapters, steel posts, wire enclosures, and doors. Casters are included with mobile units. Intermediate shelves are sold separately.

MetroMax Q Stationary Units — 66³/₁₆" (1681mm) High

Actual Outside Dimensions		Length		Fits Shelf		Approx. Pkd. Wt.		Cat. No.
Width (in.)	(mm)	(in.)	(mm)	(in.)	(mm)	(lbs.)	(kg)	
26 ¹⁵ / ₁₆	685	38 ⁷ / ₈	987	24x36	610x914	148	67	MQSEC53E
26 ¹⁵ / ₁₆	685	50 ⁷ / ₈	1292	24x48	610x1219	156	71	MQSEC55E
26 ¹⁵ / ₁₆	685	62 ⁷ / ₈	1597	24x60	610x1524	161	73	MQSEC56E

Note: Leveling foot on post can be adjusted up to 1" (25mm) to compensate for uneven floors.

MetroMax Q Stem Caster Mobile Units — 67¹³/₁₆" (1723mm) High

Models include four 5" (127mm) diameter casters with polyurethane tread; two swivel and two swivel with brakes.

Actual Outside Dimensions (including Bumpers and Handle)		Length		Fits Shelf		Approx. Pkd. Wt.		Cat. No. Includes Casters with Plated Finish		Cat. No. Includes Corrosion Resistant Polymer Casters	
Width (in.)	(mm)	(in.)	(mm)	(in.)	(mm)	(lbs.)	(kg)				
27 ¹³ / ₁₆	707	40 ³ / ₄	1035	24x36	610x914	166	75	MQSEC53DE		MQSEC53VE	
27 ¹³ / ₁₆	707	52 ³ / ₄	1340	24x48	610x1219	176	80	MQSEC55DE		MQSEC55VE	
27 ¹³ / ₁₆	707	64 ³ / ₄	1645	24x60	610x1524	179	81	MQSEC56DE		MQSEC56VE	

**"DE" models use two 5MPX and two 5MPBX casters.
 ***"VE" models use two 5PCX and two 5PCBX casters. Recommended for wet or damp environments.



Ergonomic — ¼ turn door handle

MetroMax Q Heavy-Duty Mobile Units — 68¹/₂" (1740mm) High

Mounted on aluminum dolly with 5" (127mm) plate casters and wraparound bumpers.

Actual Outside Dimensions (including Handle)		Length		Fits Shelf		Approx. Pkd. Wt.		Cat. No.
Width (in.)	(mm)	(in.)	(mm)	(in.)	(mm)	(lbs.)	(kg)	
28 ¹ / ₁₆	713	39 ¹ / ₈	994	24x36	610x914	166	75	MQSEC53LE
28 ¹ / ₁₆	713	51 ¹ / ₈	1299	24x48	610x1219	176	80	MQSEC55LE
28 ¹ / ₁₆	713	63 ¹ / ₈	1603	24x60	610x1524	179	81	MQSEC56LE

Note: The aluminum dollies used on the LE models have two B5P and two B5PB plate casters.

Intermediate Shelves

Width		Length		i		i		Q	
(in.)	(mm)	(in.)	(mm)	Cat. No. Shelf with Grid Mat		Cat. No. Shelf with Solid Mat		Cat. No. Shelf with Grid Mat	
24	610	36	914	MX2436G		MX2436F		MQ2436G	
24	610	48	1220	MX2448G		MX2448F		MQ2448G	
24	610	60	1524	MX2460G		MX2460F		MQ2460G	





Mightylite

INSULATED FOOD CARRIERS

Mightylite Front-Load Pan Carriers	140-141
Mightylite Top-Load Food Carriers.....	142
Mightylite Accessories.....	143

Mighty**lite**TM

Insulated Food Carriers

60%
Lighter
than traditionally molded carriers



Carries easy.

Ergonomic 8-handle design

Ultra light with 8 convenient handles, the ultimate design for lifting, carrying, and moving in any situation. MightyLite makes moving hot & cold food a lot easier!



Keeps Food
HotCold
5+ hrs.

Holds safe.

Safe & appetizing food every time

Load them up with food and confidently hold safe for hours. Standard size ML300 holds up to (4) full size pans, larger ML400 holds up to (6).

Lasts long.

Advanced polymer foam construction – EPP (Expanded Polypropylene)

The unbelievable strength-to-weight ratio and ability to absorb impact make MightyLite carriers perfect for lifting and withstanding the rigors of off-site food transport!

2
YEAR
WARRANTY
★ ★ ★

Lightweight

Super Strong

Insulative

Cleanable

Recyclable

MIGHTYLITE™ FRONT-LOAD PAN CARRIERS

Roll with it.

ML300 ▶

ML400 ▶



Dolly safely nests on top of the carrier for secure vehicle transport.



Mightylite dolly— Heavy-duty, 350 lb. (158kg) capacity dolly to help transport carriers. Also designed to move milk crates.



Stacks Securely: Features allow for secure stacking during transport or storage.

Mighty Door: Full-swing door for easy loading, durable travel latch, “gasketless” door seal, and large label holder/white board.



	12" x 20" – GN 1/1 Pan Capacity			Food Capacity (approx.)
	2.5" / 65mm	4" / 100mm	6" / 150mm	
ML300	4	3	2	45 qts (42.4 L)
ML400	6	4	3	60 qts (56.8 L)

ML300 & ML400 will also hold 1/3, 1/2, 2/3, fractional sized hotel / GN pans.

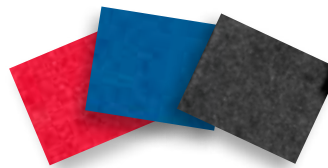

Available Lid & Door Colors

QUICK SHIP	QUICK SHIP	QUICK SHIP	Description	Dimensions (W x D x H)		Product Weight	Approx. Pkd. Wt.
RED	BLUE	BLACK		(in)	(mm)		
ML300	ML300-BU	ML300-BL	4 Pan Front Loader	17.25 x 27 x 19.75	438 x 686 x 502	9.1 lbs. (4.1 kg)	13.0 lbs. (5.9 kg)
ML400	ML400-BU	ML400-BL	6 Pan Front Loader	17.25 x 27 x 25.75	438 x 686 x 654	11.3 lbs. (5.1 kg)	15.0 lbs. (6.8 kg)

ML180XL ▶



80% Lighter
than traditional top-loaders

60% Lighter
than coolers

ML180 ▶

Stacks well with others.



The multi-purpose carrier.

Mightylite top-loaders handle more than just pans and stack well with Mightylite front-loaders. The multi-functional BigBoy lid increases storage capacity and gives you the option to use it as an insulated server.



			Description	Dimensions (W x D x H)		Product Weight	Approx. Pkd. Wt.
				(in)	(mm)		
ML180	ML180-BU	ML180-BL	Flat Lid Top-Loader	26.63 x 15.75 x 11.38	677 x 400 x 289	3.8 lbs. (1.7 kg)	5.8 lbs. (2.6 kg)
ML180XL	ML180XL-BU	ML180XL-BL	BigBoy Top-Loader	26.63 x 15.75 x 16.13	677 x 400 x 410	4.6 lbs. (2.1 kg)	7.4 lbs. (3.4 kg)

The multi-purpose carrier with **63% more** storage.



TOP-LOADER



COOLER



**Supersized.
180XL**

SERVER

	Inside Dimensions (W x D x H)		12" x 20" – GN 1/1 Pan Capacity				Food Capacity (approx.)	Inside Capacity (approx.)	Covered Plates*	Container Sizes**						
	(in)	(mm)	2.5"	4"	6"	8"				Cans 12oz.	Cans 16oz.	Bottles 12oz.	Bottles 750ml	Bottles 2L	Half Gallon	Gallon
			65mm	100mm	150mm	200mm										
ML180	21.0 x 12.9 x 8.1	533 x 327 x 205	3	2	1	1	30 qts (28.4 L)	38 qts (36.0 L)	6	40	40	36	14	8	10	4
ML180XL	21.0 x 12.9 x 13.2	533 x 327 x 335	5	3	2	1	45 qts (42.4 L)	62 qts (58.7 L)	8	80	56	43	24	14	15	6

*10.5" cover diameter and 2.75" covered plate height
 **Container capacity may vary depending on individual container size.

Stop worrying about temperature loss from frequent openings.

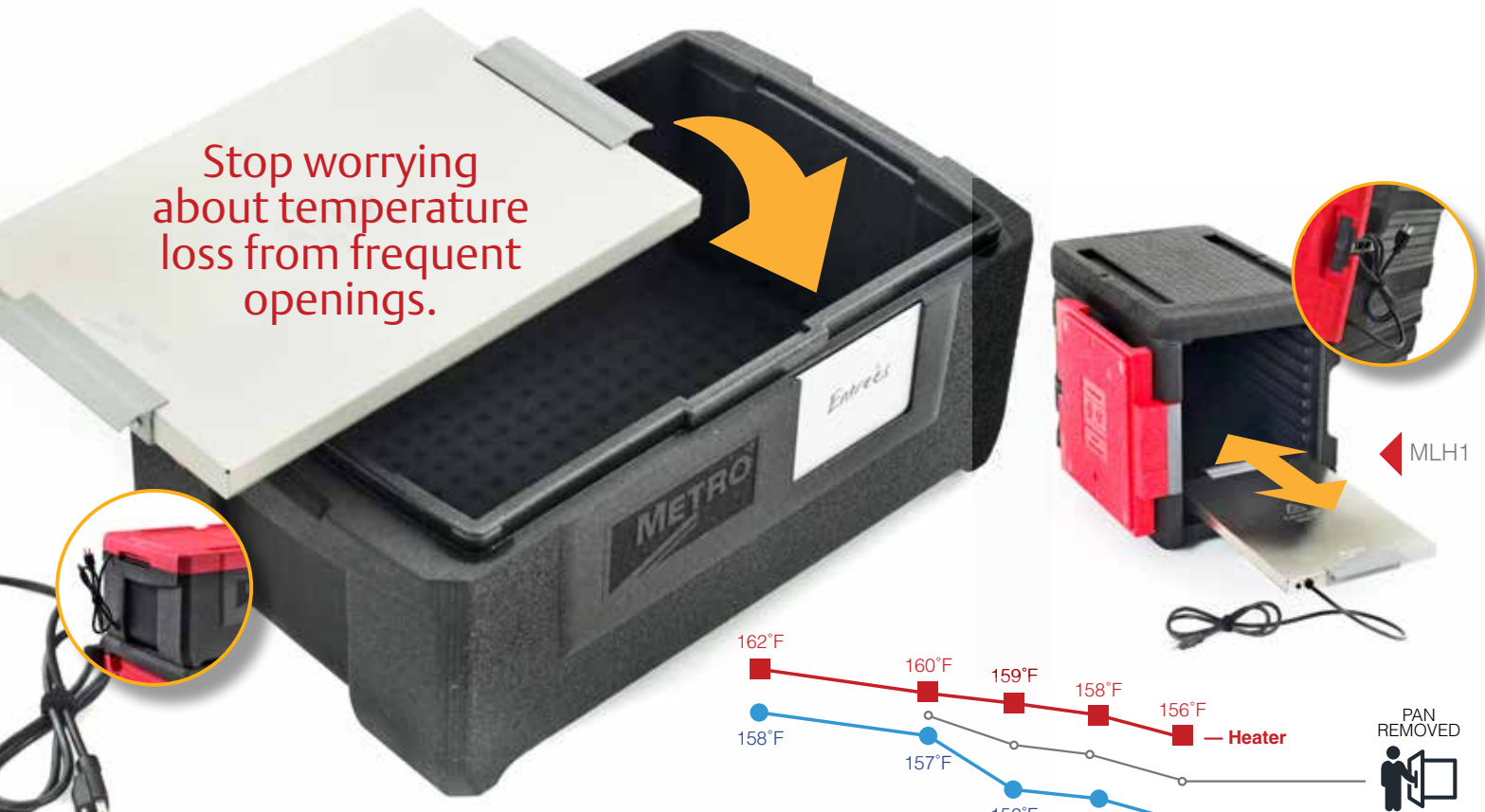

Serve it up with a serving ring and top-loader.

Endless serving possibilities. Transport and serve with a single solution that does not require water or canned fuel.

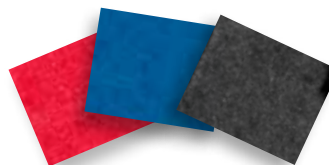
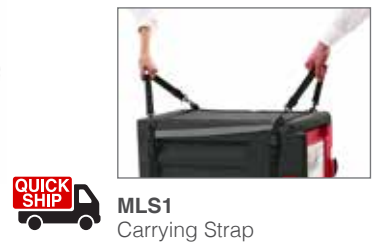

Available Lid & Door Colors

A close-up photograph of a person's hand touching a red, textured surface. The surface has a series of horizontal, wavy ridges that create a sense of depth and tactile quality. The lighting is soft, highlighting the texture of the skin and the surface. The overall mood is one of tactile innovation and human interaction with technology.

**Innovation
you can
touch.**



Metro C5®

THERMAL CABINETS & RACKS

C5® Cabinet Line & Accessories	146-187
Stationary and Mobile Holding Cabinets	146-177
Heavy-Duty Heated Transport Cabinets	178-183
Heavy-Duty Mobile Refrigerators.....	184-187
Heated Banquet Cabinets & Accessories	188-194
Holding/Delivery/Storage Cabinets.....	195-196
Mobile Bun and Tray Racks	197-200



Full, 3/4 and 1/2 height stainless steel reach-in models with solid doors



C5 9 Series

High performance insulated cabinets with precise temperature and humidity control.

Designed to maintain food quality for extended periods of time by continuously monitoring and controlling internal cabinet temperature and relative humidity levels. 9 Series cabinets put you in control of food quality.

Available Sizes

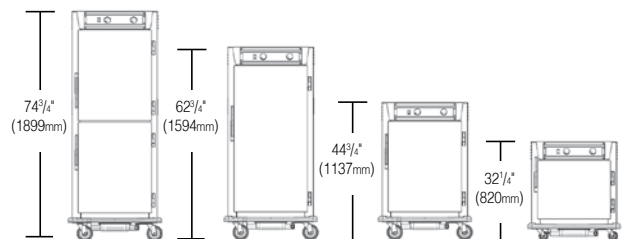

All cabinets are 30" (762mm) wide and 36.375" (924mm) deep.

Temperature
Measures and displays actual cabinet temperature.

Intuitive
Easy-to-use controls that anyone can understand.

Humidity
Measures and displays actual cabinet relative humidity.



Low-Water Alarm
A safety feature that indicates when water is needed. Water element will not be energized when water is low.



Low-Temp Alarm
Assures cabinet is operating at desired temperature.

Recall & Memory
View settings at the touch of a button. Settings are saved when turned off.

Temperature Priority

9 Series controller generates heat before humidity for food safety.



Top-Mounted Controls
Ergonomic, user-friendly controls are mounted at the top of the cabinet for improved access, to help prevent damage, and easy cleaning.



4 Gallon Reservoir
Allows you to maximize and control actual relative humidity levels inside the cabinet. Drip trough bumper is a standard feature on every 9 Series cabinet



Slides
Two systems to choose from that hold a variety of pan sizes. Universal option for maximum pan flexibility or lip load to maximize 18x26 sheet pan capacity.



Doors
Field reversible, solid or glass insulated doors with high strength magnetic pull latch for easy access.

Easy-to-Use Controls

Real-time temperature and relative humidity levels are constantly displayed, giving the foodservice professional valuable feedback. Simply turn the dial to the desired temperature or humidity setting and let the cabinet do the rest.

Heavily Insulated

2 1/2" thick, high density fiberglass insulation in your choice of stainless steel or aluminum construction.

32 ENERGY STAR models to choose from!



High Performance

High performance airflow design delivers uniform temperature and humidity throughout the cabinet by channeling hot air to the bottom of the cabinet and over the water reservoir, allowing it to rise naturally without blowing air directly over the food.

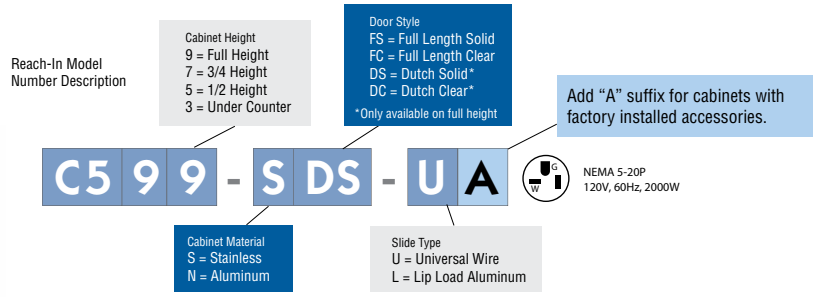

Add "L" or "X" for alternate electrical configurations (no upcharge)

C599L-SDS-U  NEMA 5-15P
 120V, 60Hz, 1440W

C599X-SDS-U  NEMA 6-15P
 220-240V, 50/60Hz, 1681-2000W

Reach-In Cabinets

9 SERIES — {13.99}

Doors	Slides	Cat. No. Stainless Steel	Approx. Pkd. Wt. (lbs.)	Cat. No. Aluminum	Approx. Pkd. Wt. (lbs.)
Full Height					
Full Solid	Universal	C599-SFS-U*	400	C599-NFS-U	270
Full Solid	Lip Load	C599-SFS-L*	390	C599-NFS-L	265
Dutch Solid	Universal	C599-SDS-U*	410	C599-NDS-U	270
Dutch Solid	Lip Load	C599-SDS-L*	400	C599-NDS-L	270
Full Clear	Universal	C599-SFC-U	410	C599-NFC-U	280
Full Clear	Lip Load	C599-SFC-L	400	C599-NFC-L	270
Dutch Clear	Universal	C599-SDC-U	410	C599-NDC-U	280
Dutch Clear	Lip Load	C599-SDC-L	400	C599-NDC-L	270
3/4 Height					
Full Solid	Universal	C597-SFS-U*	310	C597-NFS-U	210
Full Solid	Lip Load	C597-SFS-L*	300	C597-NFS-L	205
Full Clear	Universal	C597-SFC-U	307	C597-NFC-U	215
Full Clear	Lip Load	C597-SFC-L	297	C597-NFC-L	210
1/2 Height					
Full Solid	Universal	C595-SFS-U*	200	C595-NFS-U	140
Full Solid	Lip Load	C595-SFS-L*	190	C595-NFS-L	135
Full Clear	Universal	C595-SFC-U	197	C595-NFC-U	145
Full Clear	Lip Load	C595-SFC-L	187	C595-NFC-L	140
Under Counter (Not available in 120V, 2000W)					
Full Solid	Universal	C593L-SFS-U	105	C593L-NFS-U	70
Full Solid	Lip Load	C593L-SFS-L	95	C593L-NFS-L	65
Full Clear	Universal	C593L-SFC-U	100	C593L-NFC-U	75
Full Clear	Lip Load	C593L-SFC-L	90	C593L-NFC-L	70

*120V 2000W and 1440W models with and without accessories are ENERGY STAR.

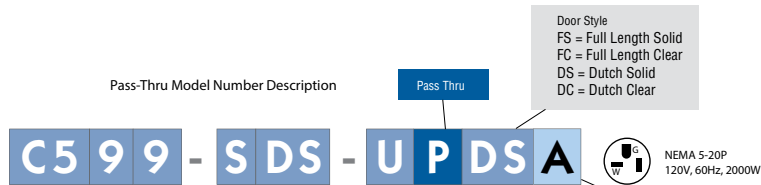

Add "L" or "X" for alternate electrical configurations (no upcharge)

Add "A" suffix for cabinets with factory installed accessories.

C599L-SDS-UPDS NEMA 5-15P
 120V, 60Hz, 1440W

C599X-SDS-UPDS NEMA 6-15P
 220-240V, 50/60Hz, 1681-2000W



Pass-Thru Cabinets (Only available in Full Height or 1/2 Height)

Doors/Rear Doors	Slides	Cat. No. Stainless Steel	Approx. Pkd. Wt. (lbs.)	Cat. No. Aluminum	Approx. Pkd. Wt. (lbs.)
Full Height Pass-Thru					
Full Solid/Full Solid	Universal	C599-SFS-UPFS	435	C599-NFS-UPFS	270
Full Solid/Full Clear	Universal	C599-SFS-UPFC	430	C599-NFS-UPFC	280
Full Solid/Full Solid	Lip Load	C599-SFS-LPFS	390	C599-NFS-LPFS	265
Full Solid/Full Clear	Lip Load	C599-SFS-LPFC	435	C599-NFS-LPFC	270
Dutch Solid/Dutch Solid	Universal	C599-SDS-UPDS	410	C599-NDS-UPDS	275
Dutch Solid/Dutch Clear	Universal	C599-SDS-UPDC	435	C599-NDS-UPDC	275
Dutch Solid/Dutch Solid	Lip Load	C599-SDS-LPDS	400	C599-NDS-LPDS	275
Dutch Solid/Dutch Clear	Lip Load	C599-SDS-LPDC	430	C599-NDS-LPDC	280
Full Clear/Full Clear	Universal	C599-SFC-UPFC	400	C599-NFC-UPFC	275
Full Clear/Full Solid	Universal	C599-SFC-UPFS	435	C599-NFC-UPFS	280
Full Clear/Full Clear	Lip Load	C599-SFC-LPFC	400	C599-NFC-LPFC	270
Full Clear/Full Solid	Lip Load	C599-SFC-LPFS	430	C599-NFC-LPFS	280
Dutch Clear/Dutch Clear	Universal	C599-SDC-UPDC	410	C599-NDC-UPDC	280
Dutch Clear/Dutch Solid	Universal	C599-SDC-UPDS	435	C599-NDC-UPDS	280
Dutch Clear/Dutch Clear	Lip Load	C599-SDC-LPDC	400	C599-NDC-LPDC	275
Dutch Clear/Dutch Solid	Lip Load	C599-SDC-LPDS	430	C599-NDC-LPDS	275
1/2 Height Pass-Thru					
Full Solid/Full Solid	Universal	C595-SFS-UPFS	210	C595-NFS-UPFS	150
Full Solid/Full Clear	Universal	C595-SFS-UPFC	218	C595-NFS-UPFC	150
Full Solid/Full Solid	Lip Load	C595-SFS-LPFS	200	C595-NFS-LPFS	145
Full Solid/Full Clear	Lip Load	C595-SFS-LPFC	205	C595-NFS-LPFC	140
Full Clear/Full Clear	Universal	C595-SFC-UPFC	207	C595-NFC-UPFC	155
Full Clear/Full Solid	Universal	C595-SFC-UPFS	218	C595-NFC-UPFS	150
Full Clear/Full Clear	Lip Load	C595-SFC-LPFC	200	C595-NFC-LPFC	145
Full Clear/Full Solid	Lip Load	C595-SFC-LPFS	205	C595-NFC-LPFS	140



Universal Slides



Lip Load Slides

Cabinet Size	Universal Wire Pan Capacity						Lip Load Pan Capacity		
	Slide Pairs		Sheet Pans	Steam Pans			Gastronorm 65mm Depth		Sheet Pans 18"x26"
	Provided	Max*	18"x26"	12"x20"x2.5"	12"x20"x4"	12"x20"x6"	2/1	1/1	
Full Height	18	36	18	34	24	14	17	34	35
Full Height Dutch	18	35	17	32	22	12	16	32	34
3/4 Height	14	28	13	26	16	12	13	26	27
1/2 Height	8	17	8	16	10	6	8	16	17
Under Counter	5	9	5	10	6	4	5	10	10

*Maximum number of slide pairs @ 1 1/2" spacing. Additional slide pairs ordered separately.



Full, 3/4 and 1/2 height stainless steel reach-in models with solid doors



C5 8 Series

High performance insulated cabinets with precise temperature control.

Designed to precisely maintain food temperature and quality by continuously monitoring and controlling internal cabinet temperature. 8 Series cabinets give you consistent results.

Available Sizes

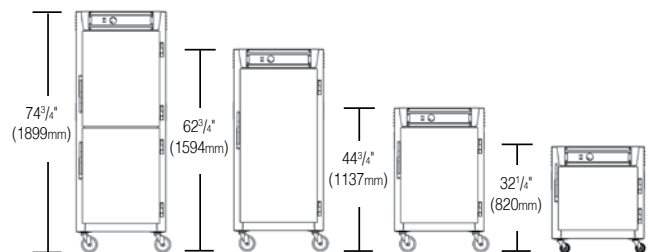

All cabinets are 29.125" (740mm) wide and 32.625" (829mm) deep (Pass-thru are 34.625" (880mm) deep).

Intuitive
Easy-to-use controls that anyone can understand.

Temperature
Measures and displays actual cabinet temperature.

Recall & Memory
View settings at the touch of a button. Settings are saved when turned off.

Low-Temp Alarm
Assures cabinet is operating at desired temperature.



Top-Mounted Controls
Ergonomic, user-friendly controls are mounted at the top of the cabinet for improved access, to help prevent damage, and easy cleaning.



Passive Humidity
Water pan is a standard feature on every 8 Series cabinet; hot air flows over water pan to help create moisture.



Slides
Two systems to choose from that hold a variety of pan sizes. Universal option for maximum pan flexibility or lip load to maximize 18x26 sheet pan capacity.



Doors
Field reversible, solid or glass insulated doors with high strength magnetic pull latch for easy access.

Easy-to-Use Controls

Real-time temperature is constantly displayed, giving the foodservice professional valuable feedback. Simply turn the dial to the desired temperature and let the cabinet do the rest.

Heavily Insulated

2 1/2" thick, high density fiberglass insulation in your choice of stainless steel or aluminum construction.

32 ENERGY STAR models to choose from!



High Performance

High performance airflow design delivers uniform temperature throughout the cabinet by channeling hot air to the bottom of the cabinet and over the passive humidity pan, allowing it to rise naturally without blowing air directly over the food.



Reach-In Model Number Description

Cabinet Height
 9 = Full Height
 7 = 3/4 Height
 5 = 1/2 Height
 3 = Under Counter

Door Style
 FS = Full Length Solid
 FC = Full Length Clear
 DS = Dutch Solid*
 DC = Dutch Clear*
 *Only available on full height

Add "A" suffix for cabinets with factory installed accessories.

C5 8 9 - S DS - U A



NEMA 5-20P
 120V, 60Hz, 2000W

Cabinet Material
 S = Stainless
 N = Aluminum

Slide Type
 U = Universal Wire
 L = Lip Load Aluminum

Add "L" or "X" for alternate electrical configurations (no upcharge)

C589L-SDS-U



NEMA 5-15P
 120V, 60Hz, 1440W

C589X-SDS-U



NEMA 6-15P
 220-240V, 50/60Hz, 1681-2000W

8 SERIES — {13.98}

Reach-In Cabinets

Doors	Slides	Cat. No. Stainless Steel	Approx. Pkd. Wt. (lbs.)	Cat. No. Aluminum	Approx. Pkd. Wt. (lbs.)
Full Height					
Full Solid	Universal	C589-SFS-U*	375	C589-NFS-U	270
Full Solid	Lip Load	C589-SFS-L*	365	C589-NFS-L	265
Dutch Solid	Universal	C589-SDS-U*	385	C589-NDS-U	275
Dutch Solid	Lip Load	C589-SDS-L*	375	C589-NDS-L	270
Full Clear	Universal	C589-SFC-U	415	C589-NFC-U	275
Full Clear	Lip Load	C589-SFC-L	415	C589-NFC-L	270
Dutch Clear	Universal	C589-SDC-U	415	C589-NDC-U	280
Dutch Clear	Lip Load	C589-SDC-L	415	C589-NDC-L	270
3/4 Height					
Full Solid	Universal	C587-SFS-U*	285	C587-NFS-U	210
Full Solid	Lip Load	C587-SFS-L*	307	C587-NFS-L	205
Full Clear	Universal	C587-SFC-U	307	C587-NFC-U	215
Full Clear	Lip Load	C587-SFC-L	280	C587-NFC-L	210
1/2 Height					
Full Solid	Universal	C585-SFS-U*	175	C585-NFS-U	140
Full Solid	Lip Load	C585-SFS-L*	175	C585-NFS-L	135
Full Clear	Universal	C585-SFC-U	205	C585-NFC-U	145
Full Clear	Lip Load	C585-SFC-L	205	C585-NFC-L	140
Under Counter (Not available in 120V, 2000W)					
Full Solid	Universal	C583L-SFS-U	80	C583L-NFS-U	70
Full Solid	Lip Load	C583L-SFS-L	70	C583L-NFS-L	65
Full Clear	Universal	C583L-SFC-U	105	C583L-NFC-U	75
Full Clear	Lip Load	C583L-SFC-L	100	C583L-NFC-L	70

*120V 2000W and 1440W models with and without accessories are ENERGY STAR.

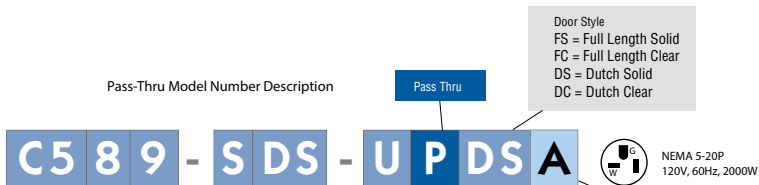

Add "L" or "X" for alternate electrical configurations (no upcharge)

Add "A" suffix for cabinets with factory installed accessories.

C589L-SDS-UPDS NEMA 5-15P
 120V, 60Hz, 1440W

C589X-SDS-UPDS NEMA 6-15P
 220-240V, 50/60Hz, 1681-2000W



Pass-Thru Cabinets (Only available in Full Height or 1/2 Height)

Doors/Rear Doors	Slides	Cat. No. Stainless Steel	Approx. Pkd. Wt. (lbs.)	Cat. No. Aluminum	Approx. Pkd. Wt. (lbs.)
Full Height Pass-Thru					
Full Solid/Full Solid	Universal	C589-SFS-UPFS	375	C589-NFS-UPFS	270
Full Solid/Full Clear	Universal	C589-SFS-UPFC	435	C589-NFS-UPFC	280
Full Solid/Full Solid	Lip Load	C589-SFS-LPFS	385	C589-NFS-LPFS	265
Full Solid/Full Clear	Lip Load	C589-SFS-LPFC	435	C589-NFS-LPFC	275
Dutch Solid/Dutch Solid	Universal	C589-SDS-UPDS	380	C589-NDS-UPDS	275
Dutch Solid/Dutch Clear	Universal	C589-SDS-UPDC	430	C589-NDS-UPDC	275
Dutch Solid/Dutch Solid	Lip Load	C589-SDS-LPDS	390	C589-NDS-LPDS	270
Dutch Solid/Dutch Clear	Lip Load	C589-SDS-LPDC	430	C589-NDS-LPDC	270
Full Clear/Full Clear	Universal	C589-SFC-UPFC	400	C589-NFC-UPFC	275
Full Clear/Full Solid	Universal	C589-SFC-UPFS	435	C589-NFC-UPFS	280
Full Clear/Full Clear	Lip Load	C589-SFC-LPFC	390	C589-NFC-LPFC	270
Full Clear/Full Solid	Lip Load	C589-SFC-LPFS	435	C589-NFC-LPFS	275
Dutch Clear/Dutch Clear	Universal	C589-SDC-UPDC	410	C589-NDC-UPDC	280
Dutch Clear/Dutch Solid	Universal	C589-SDC-UPDS	435	C589-NDC-UPDS	275
Dutch Clear/Dutch Clear	Lip Load	C589-SDC-LPDC	400	C589-NDC-LPDC	275
Dutch Clear/Dutch Solid	Lip Load	C589-SDC-LPDS	435	C589-NDC-LPDS	270
1/2 Height Pass-Thru					
Full Solid/Full Solid	Universal	C585-SFS-UPFS	170	C585-NFS-UPFS	150
Full Solid/Full Clear	Universal	C585-SFS-UPFC	218	C585-NFS-UPFC	150
Full Solid/Full Solid	Lip Load	C585-SFS-LPFS	165	C585-NFS-LPFS	145
Full Solid/Full Clear	Lip Load	C585-SFS-LPFC	210	C585-NFS-LPFC	140
Full Clear/Full Clear	Universal	C585-SFC-UPFC	218	C585-NFC-UPFC	155
Full Clear/Full Solid	Universal	C585-SFC-UPFS	218	C585-NFC-UPFS	150
Full Clear/Full Clear	Lip Load	C585-SFC-LPFC	210	C585-NFC-LPFC	145
Full Clear/Full Solid	Lip Load	C585-SFC-LPFS	210	C585-NFC-LPFS	140



Universal Slides



Lip Load Slides

Cabinet Size	Universal Wire Pan Capacity						Lip Load Pan Capacity		
	Slide Pairs		Sheet Pans	Steam Pans			Gastronorm 65mm Depth		Sheet Pans 18"x26"
	Provided	Max*	18"x26"	12"x20"x2.5"	12"x20"x4"	12"x20"x6"	2/1	1/1	
Full Height	18	36	18	34	24	14	17	34	35
Full Height Dutch	18	35	17	32	22	12	16	32	34
3/4 Height	14	28	13	26	16	12	13	26	27
1/2 Height	8	17	8	16	10	6	8	16	17
Under Counter	5	9	5	10	6	4	5	10	10

*Maximum number of slide pairs @ 1 1/2" spacing. Additional slide pairs ordered separately.



C5 6 Series

High performance insulated cabinets with traditional temperature control.

Designed to maintain food temperature and quality by continuously monitoring and controlling internal cabinet temperature. 6 Series cabinets give you professional results.

available Sizes

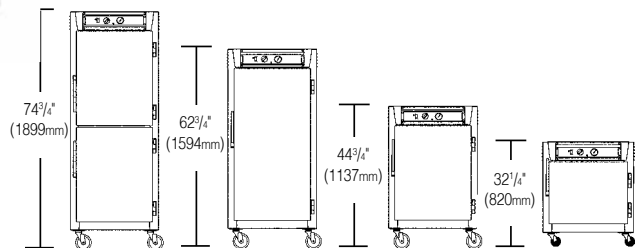

All cabinets are 29.125" (740mm) wide and 32.625" (829mm) deep (Pass-thru are 34.625" (880mm) deep).



Full and 3/4 height stainless steel reach-in models with solid doors and all 1/2 height stainless steel reach-in models



Temperature
The easy-to-use dial puts you in control of cabinet temperature.

Reliable Readout
Measures and displays actual cabinet temperature even when the cabinet is off.



Top-Mounted Controls
Ergonomic, user-friendly controls are mounted at the top of the cabinet for improved access, to help prevent damage, and easy cleaning.



Passive Humidity
Water pan is a standard feature on every 6 Series cabinet; hot air flows over water pan to help create moisture.



Slides
Two systems to choose from that hold a variety of pan sizes. Universal option for maximum pan flexibility or lip load to maximize 18x26 sheet pan capacity.



Doors
Field reversible, solid or glass insulated doors with high strength magnetic pull latch for easy access.

Traditional Controls

Electro-mechanical thermostat and “always-on” analog thermometer for continuous monitoring of cabinet temperature, even when turned off or unplugged.

Heavily Insulated

2½" thick, high-density fiberglass insulation in your choice of stainless steel or aluminum construction.

36 ENERGY STAR models to choose from!



High Performance

High performance airflow design delivers uniform temperature throughout the cabinet by channeling hot air to the bottom of the cabinet and over the passive humidity pan, allowing it to rise naturally without blowing air directly over the food.

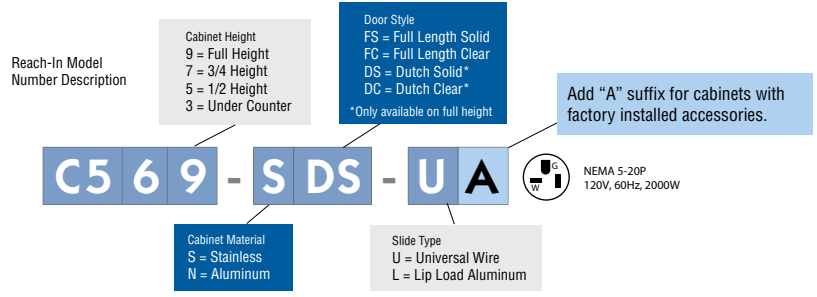

Add "L" or "X" for alternate electrical configurations (no upcharge)

C569L-SDS-U  NEMA 5-15P
 120V, 60Hz, 1440W

C569X-SDS-U  NEMA 6-15P
 220-240V, 50/60Hz, 1681-2000W

6 SERIES — {13.96}

Reach-In Cabinets

Doors	Slides	Cat. No. Stainless Steel	Approx. Pkd. Wt. (lbs.)	Cat. No. Aluminum	Approx. Pkd. Wt. (lbs.)
Full Height					
Full Solid	Universal	C569-SFS-U*	375	C569-NFS-U	270
Full Solid	Lip Load	C569-SFS-L*	365	C569-NFS-L	265
Dutch Solid	Universal	C569-SDS-U*	385	C569-NDS-U	275
Dutch Solid	Lip Load	C569-SDS-L*	375	C569-NDS-L	270
Full Clear	Universal	C569-SFC-U	415	C569-NFC-U	275
Full Clear	Lip Load	C569-SFC-L	415	C569-NFC-L	270
Dutch Clear	Universal	C569-SDC-U	415	C569-NDC-U	280
Dutch Clear	Lip Load	C569-SDC-L	415	C569-NDC-L	270
3/4 Height					
Full Solid	Universal	C567-SFS-U*	285	C567-NFS-U	210
Full Solid	Lip Load	C567-SFS-L*	307	C567-NFS-L	205
Full Clear	Universal	C567-SFC-U	307	C567-NFC-U	215
Full Clear	Lip Load	C567-SFC-L	280	C567-NFC-L	210
1/2 Height					
Full Solid	Universal	C565-SFS-U*	175	C565-NFS-U	140
Full Solid	Lip Load	C565-SFS-L*	175	C565-NFS-L	135
Full Clear	Universal	C565-SFC-U*	205	C565-NFC-U	145
Full Clear	Lip Load	C565-SFC-L*	205	C565-NFC-L	140
Under Counter (Not available in 120V, 2000W)					
Full Solid	Universal	C563L-SFS-U	80	C563L-NFS-U	70
Full Solid	Lip Load	C563L-SFS-L	70	C563L-NFS-L	65
Full Clear	Universal	C563L-SFC-U	105	C563L-NFC-U	75
Full Clear	Lip Load	C563L-SFC-L	100	C563L-NFC-L	70

*120V 2000W and 1440W models with and without accessories are ENERGY STAR.

Pass-Thru Model Number Description

C569 - SDS - UPDS A

Door Style
 FS = Full Length Solid
 FC = Full Length Clear
 DS = Dutch Solid
 DC = Dutch Clear



NEMA 5-20P
 120V, 60Hz, 2000W

Add "L" or "X" for alternate electrical configurations (no upcharge)

Add "A" suffix for cabinets with factory installed accessories.

C569L-SDS-UPDS  NEMA 5-15P
 120V, 60Hz, 1440W

C569X-SDS-UPDS  NEMA 6-15P
 220-240V, 50/60Hz, 1681-2000W



Pass-Thru Cabinets (Only available in Full Height or 1/2 Height)

Doors/Rear Doors	Slides	Cat. No. Stainless Steel	Approx. Pkd. Wt. (lbs.)	Cat. No. Aluminum	Approx. Pkd. Wt. (lbs.)
Full Height Pass-Thru					
Full Solid/Full Solid	Universal	C569-SFS-UPFS	375	C569-NFS-UPFS	270
Full Solid/Full Clear	Universal	C569-SFS-UPFC	435	C569-NFS-UPFC	280
Full Solid/Full Solid	Lip Load	C569-SFS-LPFS	385	C569-NFS-LPFS	265
Full Solid/Full Clear	Lip Load	C569-SFS-LPFC	435	C569-NFS-LPFC	275
Dutch Solid/Dutch Solid	Universal	C569-SDS-UPDS	380	C569-NDS-UPDS	275
Dutch Solid/Dutch Clear	Universal	C569-SDS-UPDC	430	C569-NDS-UPDC	275
Dutch Solid/Dutch Solid	Lip Load	C569-SDS-LPDS	390	C569-NDS-LPDS	270
Dutch Solid/Dutch Clear	Lip Load	C569-SDS-LPDC	430	C569-NDS-LPDC	270
Full Clear/Full Clear	Universal	C569-SFC-UPFC	400	C569-NFC-UPFC	275
Full Clear/Full Solid	Universal	C569-SFC-UPFS	435	C569-NFC-UPFS	280
Full Clear/Full Clear	Lip Load	C569-SFC-LPFC	390	C569-NFC-LPFC	270
Full Clear/Full Solid	Lip Load	C569-SFC-LPFS	435	C569-NFC-LPFS	275
Dutch Clear/Dutch Clear	Universal	C569-SDC-UPDC	410	C569-NDC-UPDC	280
Dutch Clear/Dutch Solid	Universal	C569-SDC-UPDS	435	C569-NDC-UPDS	275
Dutch Clear/Dutch Clear	Lip Load	C569-SDC-LPDC	400	C569-NDC-LPDC	275
Dutch Clear/Dutch Solid	Lip Load	C569-SDC-LPDS	435	C569-NDC-LPDS	270
1/2 Height Pass-Thru					
Full Solid/Full Solid	Universal	C565-SFS-UPFS	170	C565-NFS-UPFS	150
Full Solid/Full Clear	Universal	C565-SFS-UPFC	218	C565-NFS-UPFC	150
Full Solid/Full Solid	Lip Load	C565-SFS-LPFS	165	C565-NFS-LPFS	145
Full Solid/Full Clear	Lip Load	C565-SFS-LPFC	210	C565-NFS-LPFC	140
Full Clear/Full Clear	Universal	C565-SFC-UPFC	218	C565-NFC-UPFC	155
Full Clear/Full Solid	Universal	C565-SFC-UPFS	218	C565-NFC-UPFS	150
Full Clear/Full Clear	Lip Load	C565-SFC-LPFC	210	C565-NFC-LPFC	145
Full Clear/Full Solid	Lip Load	C565-SFC-LPFS	210	C565-NFC-LPFS	140



Universal Slides



Lip Load Slides

Cabinet Size	Universal Wire Pan Capacity						Lip Load Pan Capacity		
	Slide Pairs		Sheet Pans	Steam Pans			Gastronorm 65mm Depth		Sheet Pans 18"x26"
	Provided	Max*	18"x26"	12"x20"x2.5"	12"x20"x4"	12"x20"x6"	2/1	1/1	
Full Height	18	36	18	34	24	14	17	34	35
Full Height Dutch	18	35	17	32	22	12	16	32	34
3/4 Height	14	28	13	26	16	12	13	26	27
1/2 Height	8	17	8	16	10	6	8	16	17
Under Counter	5	9	5	10	6	4	5	10	10

*Maximum number of slide pairs @ 1 1/2" spacing. Additional slide pairs ordered separately.

C5 9, 8, 6 SERIES ACCESSORIES

Rear Push Handle

Stainless steel tubular handle mounted on rear side of the cabinet for mobile applications.



Description	Cat. No.
Rear Push Handle	C5-HANDLE*

*Not available on pass-thru models

Bumper Options

Description	Cat. No.
Full Perimeter Bumper	C5-PERMBUMP
Polymer Corner Bumper/Drip Trough*	C5-BUMPDRI

*Note: Standard feature on 9 Series cabinets

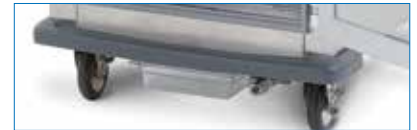

Polymer Corner Bumper



Full Perimeter Bumper

Door, Plug & Caster Options

Description	Cat. No.
Travel Latch / Hasp	C59-TRVL
Flush Door Latch*	C5-LATCHFLUSH
Key Locking Door Latch (not available on under counter models)*	C5-LATCHLOCK
Whiteboard / Clipboard Information Panel***	C5-INFOPNL
Factory Left-Hand Door Hinging	DD3768
Factory Same-Side Pass-thru Door Hinging	C5-SAMESIDE
Straight Plug (20 Amp, 120V) — in lieu of standard**	C5-STRPLG-20
Straight Plug (15 Amp, 120V) — in lieu of standard**	C5-STRPLG-15
Twist Lock Plug (20 Amp, 120V) — in lieu of standard**	C5-RTWSTPLG
Twist Lock Plug (15 Amp, 120V) — in lieu of standard**	C5-RTWSTPLG-15
5" Rear Rigid Casters (pair) — in lieu of standard	C5-5RDGCSTR
6" Casters (set of 4 swivel) — in lieu of standard	C5-6CASTER
6" Stainless Steel Legs (set of 4) — in lieu of casters	C5-SSLEGS

*Note: Order (1) per door (ie — dutch, pass-thru models require 4 each).

**Note: 9,8,6 Series 120V units come standard with right angle plug, straight plug standard on 220-240V units.

***Note: Only available on solid doors.

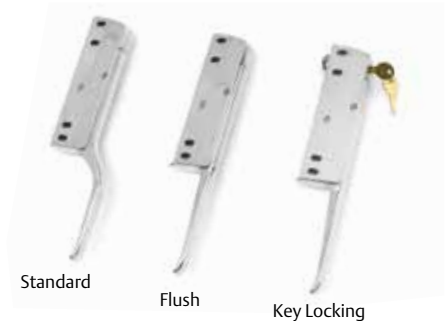

Standard

Flush

Key Locking

Slide & Shelf Options

Description	Cat. No.
Extra Universal Slide Pair (2 pieces) Chrome	C5-USLIDEPR-C
Extra Universal Slide Pair (2 pieces) Stainless Steel	C5-USLIDEPR-S
Full Height Stainless Steel Universal Slide Upgrade*	C5-USLIDE-9S
3/4 Height Stainless Steel Universal Slide Upgrade*	C5-USLIDE-7S
1/2 Height Stainless Steel Universal Slide Upgrade*	C5-USLIDE-5S
Under Counter Stainless Steel Universal Slide Upgrade*	C5-USLIDE-3S
Small Item Shelf**	C5-SHELF-S
(4) Wire Shelves in Lieu of Universal Slides (full height models)*	C5-SHELFONLY-9S
(3) Wire Shelves in Lieu of Universal Slides (3/4 height models)*	C5-SHELFONLY-7S
(2) Wire Shelves in Lieu of Universal Slides (1/2 height models)*	C5-SHELFONLY-5S
(2) Wire Shelves in Lieu of Universal Slides (under counter models)*	C5-SHELFONLY-3S

*Note: Must order universal slide model ("U")

**Note: Can only be used with universal slides ("U"). Does not work with lip-load slides



Right Angle Plug

Twist Lock Plug

Straight Plug



Small Item Shelf

CONTROL PANEL COVER

Locking cover protects settings but allows cabinet to be turned on and off.

Description	Cat. No.
Control Panel Cover	C5-COVER



RECOMMENDED C5 9 SERIES FOOD SETTINGS



PRODUCT	TEMPERATURE °F (°C)	RELATIVE HUMIDITY %*	PRODUCT	TEMPERATURE °F (°C)	RELATIVE HUMIDITY %*
MEATS			VEGETABLES		
Prime Rib	175 (79)	75	Broccoli, Spears	175 (79)	70
Hamburgers	180 (82)	60	Carrots, Sliced, Crinkled	175 (79)	70
Hot Dogs	170 (77)	70	Cauliflower, Clusters IQF	175 (79)	70
Roast Beef	175 (79)	65	Corn on the Cob	180 (82)	75
Roast Pork	175 (79)	65	Mixed Vegetables	175 (79)	70
Ribs (Pork Spareribs)	175 (79)	70	STARCHES		
FISH			Fry, Regular 3/8"	195 (91)	OFF ²
Fish, Baked (Cod Loin) IQF	170 (77)	45	Potatoes, Mashed	175 (79)	70
Fish, Batter Dipped	175 (79)	30	Potatoes, Baked	180 (82)	65
POULTRY			Potatoes, Scalloped	175 (79)	75
Chicken, Boneless, Skinless	175 (79)	70	Pasta, Elbow Macaroni	180 (82)	55
Chicken, Thigh, Baked, Fried	175 (79)	70	Rice	180 (82)	75
Chicken, Full Breast	175 (79)	70	Lasagna, Meat Sauce & Cheese	185 (85)	70
Chicken, Drum, Baked, Fried	175 (79)	55	Beans	175 (79)	65
Chicken, Leg	175 (79)	70	BREADS		
Chicken, Fried Full Breast	175 (79)	45	Biscuit, Buttermilk Mini	175 (79)	OFF ¹
Chicken, Fried Thigh	175 (79)	45	Croissants, Sliced	155 (68)	OFF ¹
Chicken, Fried Drum	175 (79)	45	French Toast, Thin Slice	175 (79)	OFF ¹
Chicken, Fried Boneless Skinless	175 (79)	45	Waffles, Original	175 (79)	OFF ¹
Chicken, Whole Roasted	170 (77)	65	Pancakes	175 (79)	OFF ¹
Turkey	175 (79)	70	Pizza	175 (79)	OFF ²
			Rolls	175 (79)	OFF ¹
			Dough (Proofing)	90 - 100 (32 - 38)	80 - 90

Developed in conjunction with the Center for Food Innovation (CFI), Penn State University
Temperature settings remain the same for non-humidity controlled cabinets.

(1) Water Reservoir **FULL**

(2) Water Reservoir **EMPTY**

* NOTE: Recommended Humidity Set point. Readout will display relative humidity inside the cabinet based on actual conditions and may vary from set point based on door opening, quantity and temperature of food, and moisture content of food. Use feedback to vary settings as required for individual products and desired results.

** NOTE: When Relative Humidity is set to OFF the cabinet will not generate additional humidity but will continue to display the actual relative humidity inside the cabinet. To reduce humidity further, increase the temperature setting and/or drain the water reservoir.



**Performance
& Value**



All models with solid doors are ENERGY STAR



C5 4 Series with Insulation Armour™ Plus

High performance holding and energy efficiency at a lower initial investment.

Metro's innovative hybrid polymer - stainless steel design exceeds traditional double wall fiberglass cabinet construction by replacing the costly exterior layer of sheet metal with foamed-in-place polyurethane insulated polymer panels. Performance and value at the 4-front of innovation, Insulation Armour™ Plus provides superior energy efficiency, built-in vertical handles, and full body bumper protection at the right price!

Dimensions

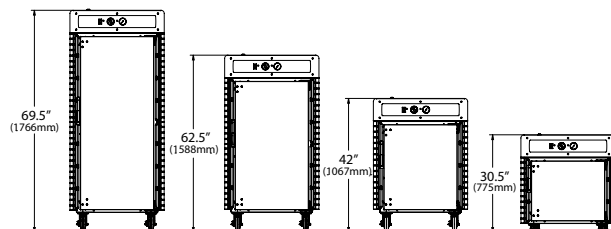

All cabinets are 30" (762mm) wide and 33" (838mm) deep

Innovative Design.

Superior Energy Efficiency

Polymer panels with foamed-in-place polyurethane insulation retain heat and save energy.



Top-Mounted Controls

Ergonomic, user-friendly controls are mounted at the top of the cabinet for improved access, to help prevent damage, and easy cleaning.



Consistent Airflow

High performance airflow design gently circulates hot air for improved temperature consistency. Air is channeled to the bottom of the cabinet, then rises naturally without blowing directly over the food.



Armour Panels

Panels have molded-in handles and act as a full-body bumper for improved handling and protection in mobile applications.



Slides

Two systems to choose from that hold a variety of pan sizes. Universal option for maximum pan flexibility or lip load to maximize 18x26 sheet pan capacity.



Heavy-Duty Door & Hinges

Field reversible stainless steel door with 2" thick high-density fiberglass insulation and 11-gauge stainless steel hinges.



Stainless Steel Construction

High-quality Type 304 stainless steel for easy cleaning and long-term durability.



Model Number Description

Cabinet Height
 9 = Full Height
 8 = 5/6 Height
 5 = 1/2 Height
 3 = Under Counter

Door Style
 FS = Full Length Solid
 FC = Full Length Clear
 DS = Dutch Solid*
 DC = Dutch Clear*
 *Only available on full height

Add "A" suffix for cabinets with factory installed accessories.

C549-ASFS-U



NEMA 5-15P
 120V, 60Hz, 1400W

Slide Type
 U = Universal Wire
 L = Lip Load Aluminum

Add "X" for alternate electrical configurations (no upcharge)

C549X-ASFS-U



NEMA 6-15P
 220-240V, 50/60Hz, 1176-1400W

4 SERIES — {13.94}
 WITH INSULATION
 ARMOUR™ PLUS

Electrical	Doors	Slides	Cat No.	Approx. Pkd. Wt. (lbs.)
Full Height				
120V, 60 Hz	Full Solid	Universal	C549-ASFS-U*	345
120V, 60 Hz	Full Solid	Lip Load	C549-ASFS-L*	325
120V, 60 Hz	Dutch Solid	Universal	C549-ASDS-U*	345
120V, 60 Hz	Dutch Solid	Lip Load	C549-ASDS-L*	325
120V, 60 Hz	Dutch Clear	Universal	C549-ASDC-U	351
120V, 60 Hz	Dutch Clear	Lip Load	C549-ASDC-L	331
220-240V, 50/60Hz	Full Solid	Universal	C549X-ASFS-U	345
220-240V, 50/60Hz	Dutch Solid	Universal	C549X-ASDS-U	345
220-240V, 50/60Hz	Dutch Clear	Universal	C549X-ASDC-U	351
5/6 Height				
120V, 60 Hz	Full Solid	Universal	C548-ASFS-U*	305
120V, 60 Hz	Full Solid	Lip Load	C548-ASFS-L*	287
220-240V, 50/60Hz	Full Solid	Universal	C548X-ASFS-U	305
1/2 Height				
120V, 60 Hz	Full Solid	Universal	C545-ASFS-U*	260
120V, 60 Hz	Full Solid	Lip Load	C545-ASFS-L*	245
220-240V, 50/60Hz	Full Solid	Universal	C545X-ASFS-U	260
Under Counter				
120V, 60 Hz	Full Solid	Universal	C543-ASFS-U*	212
120V, 60 Hz	Full Solid	Lip Load	C543-ASFS-L*	204
120V, 60 Hz	Full Clear	Universal	C543-ASFC-U	215
120V, 60 Hz	Full Clear	Lip Load	C543-ASFC-L	207
220-240V, 50/60Hz	Full Solid	Universal	C543X-ASFS-U	212
220-240V, 50/60Hz	Full Clear	Universal	C543X-ASFC-U	215

*120V solid door models with and without accessories are ENERGY STAR.



Universal Slides



Lip Load Slides

Cabinet Size	Universal Wire Pan Capacity						Lip Load Pan Capacity		
	Slide Pairs		Sheet Pans	Steam Pans			Gastronorm 65mm Depth		Sheet Pans
	Provided	Max*	18"x26"	12"x20"x2.5"	12"x20"x4"	12"x20"x6"	2/1	1/1	18"x26"
Full Height	17	34	17	34	22	14	17	34	34
Full Height Dutch	16	32	16	32	20	12	16	32	32
5/6 Height	14	29	14	28	20	12	14	28	29
1/2 Height	8	15	8	16	10	6	8	16	16
Under Counter	5	10	5	10	6	4	5	10	11

*Maximum number of slide pairs @ 1 1/2" spacing. Additional slide pairs ordered separately.

ACCESSORIES

Door, Plug & Caster Options

Description	Cat. No.
Travel Latch/Hasp*	C54-TRVL
Factory Left-Hand Door Hinging	DD3768
Straight Plug (15 Amp, 120V) — in lieu of standard**	C5-STRPLG-15
Twist Lock Plug (15 Amp, 120V) — in lieu of standard**	C5-RTWSTPLG-15
5" Rear Rigid Casters (pair) — in lieu of standard	C5-5RDGCSTR
6" Casters (set of 4 swivel) — in lieu of standard	C5-6CASTER
6" Stainless Steel Legs (set of 4) — in lieu of casters	C5-SSLEGS

*Note: C54-TRVL is only available on full, 5/6, 1/2 height solid doors (not available on clear doors or under counter cabinets).

**Note: 120V units come standard with right angle plug, straight plug standard on 220-240V units.



C54-TRVL



Stainless steel leg option available for counter top applications.

Slide & Shelf Options

Description	Cat. No.
Extra Universal Slide Pair (2 pieces) Chrome	C5-USLIDEPR-C
Extra Universal Slide Pair (2 pieces) Stainless Steel	C5-USLIDEPR-S
Full Height Stainless Steel Universal Slide Upgrade*	C5-USLIDE-9S
5/6 Height Stainless Steel Universal Slide Upgrade*	C5-USLIDE-7S
1/2 Height Stainless Steel Universal Slide Upgrade*	C5-USLIDE-5S
Under Counter Stainless Steel Universal Slide Upgrade*	C5-USLIDE-3S
Small Item Shelf**	C5-SHELF-S
(4) Wire Shelves in Lieu of Universal Slides (full height models)*	C5-SHELFONLY-9S
(3) Wire Shelves in Lieu of Universal Slides (5/6 height models)*	C5-SHELFONLY-7S
(2) Wire Shelves in Lieu of Universal Slides (1/2 height models)*	C5-SHELFONLY-5S
(2) Wire Shelves in Lieu of Universal Slides (under counter models)*	C5-SHELFONLY-3S

*Note: Must order universal slide model ("U")

**Note: Can only be used with universal slides ("U"). Does not work with lip-load slides



Small Item Shelf



C5 4 Series with Insulation Armour™ Plus

**Hot or cold insulated food transport.
Performance and value in every square inch.**

Metro's innovative hybrid polymer–stainless steel design exceeds common polymer insulated transport cart construction in a variety of ways: Foamed-in-place insulation helps to safely hold food hot for 5 hours or cold for 3 hours, high-quality stainless steel makes for easy cleaning and long-term durability, and greater pan capacity will save space and help reduce food transport expenditures.



Dimensions

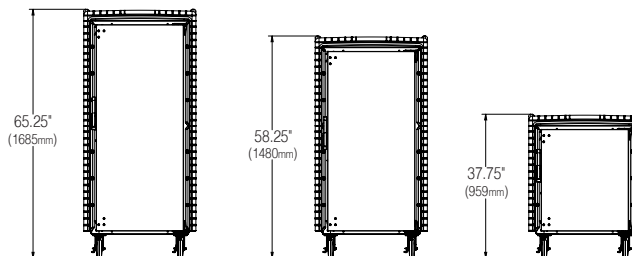

All cabinets are 30" (762mm) wide and 33" (838mm) deep

Add "A" suffix for cabinets with factory installed accessories.

C549N-SUA

Cabinet Height
9 = Full Height
8 = 5/6 Height
5 = 1/2 Height

Slide Type
U = Universal Wire
L = Lip Load Aluminum

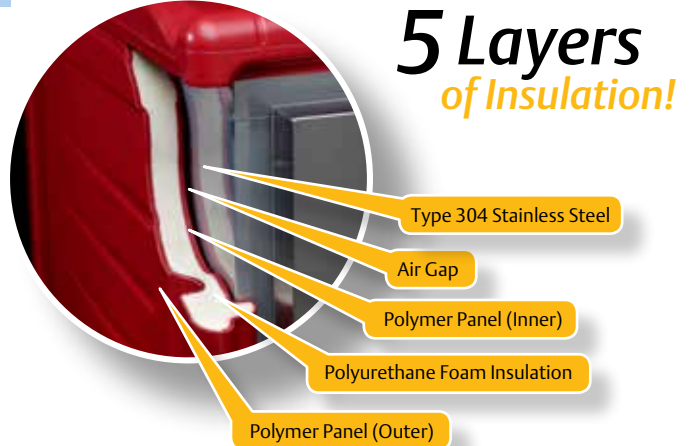

Size	Slides	Approx. Pkd. Wt. (lbs.)	Cat No.
Full	Universal	309	C549N-SU
Full	Lip Load	284	C549N-SL
5/6 Height	Universal	275	C548N-SU
5/6 Height	Lip Load	257	C548N-SL
1/2 Height	Universal	230	C545N-SU
1/2 Height	Lip Load	215	C545N-SL

Holds UP TO 60% MORE
12X20 / GN PANS PER SQ FT

HOLD MORE, SAVE SPACE, REDUCE LABOR

FITS BOTH
12X20 / GN PANS & 18X26 PANS

FLEXIBILITY TO HOLD MORE YOUR WAY

Cabinet Size	Universal Wire Pan Capacity						Lip Load Pan Capacity		
	Slide Pairs		Sheet Pans	Steam Pans			Gastronorm 65mm Depth		Sheet Pans
	Provided	Max*	18"x26"	12"x20"x2.5"	12"x20"x4"	12"x20"x6"	2/1	1/1	18"x26"
Full Height	17	34	17	34	22	14	17	34	34
5/6 Height	14	29	14	28	20	12	14	28	29
1/2 Height	8	15	8	16	10	6	8	16	16

*Maximum number of slide pairs @ 1/2" spacing. Additional slide pairs ordered separately.

ACCESSORIES

Door, Plug & Caster Options

Description	Cat. No.
Travel Latch / Hasp	C54-TRVL
Factory Left-Hand Door Hinging	DD3768
5" Rear Rigid Casters (pair) — in lieu of standard	C5-5RDGCSTR
6" Casters (set of 4 swivel) — in lieu of standard	C5-6CASTER

Slide & Shelf Options

Description	Cat. No.
Extra Universal Slide Pair (2 pieces) Chrome	C5-USLIDEPR-C
Extra Universal Slide Pair (2 pieces) Stainless Steel	C5-USLIDEPR-S
Full Height Stainless Steel Universal Slide Upgrade*	C5-USLIDE-9S
5/6 Height Stainless Steel Universal Slide Upgrade*	C5-USLIDE-7S
1/2 Height Stainless Steel Universal Slide Upgrade*	C5-USLIDE-5S
Small Item Shelf**	C5-SHELF-S
(4) Wire Shelves in Lieu of Universal Slides (full height models)*	C5-SHELFONLY-9S
(3) Wire Shelves in Lieu of Universal Slides (5/6 height models)*	C5-SHELFONLY-7S
(2) Wire Shelves in Lieu of Universal Slides (1/2 height models)*	C5-SHELFONLY-5S

*Note: Must order universal slide model ("U")

**Note: Can only be used with universal slides ("U"). Does not work with lip-load slides





C5 3 Series with Insulation Armour™

Cool-to-touch design provides energy efficiency at a lower initial investment.

Insulation Armour insulates the cabinet and protects employees from hot surfaces. Built-in hand holds and full-body bumper protection make it easy to handle when used in mobile applications.

Available Sizes

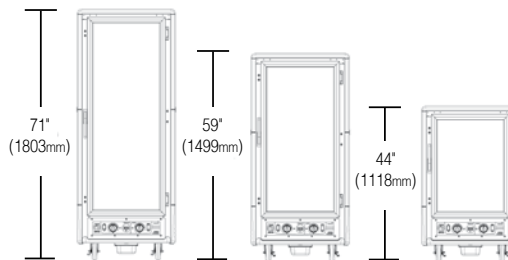

All cabinets are 27⁵/₈" (702mm) wide and 31¹/₂" (800mm) deep (aluminum construction).

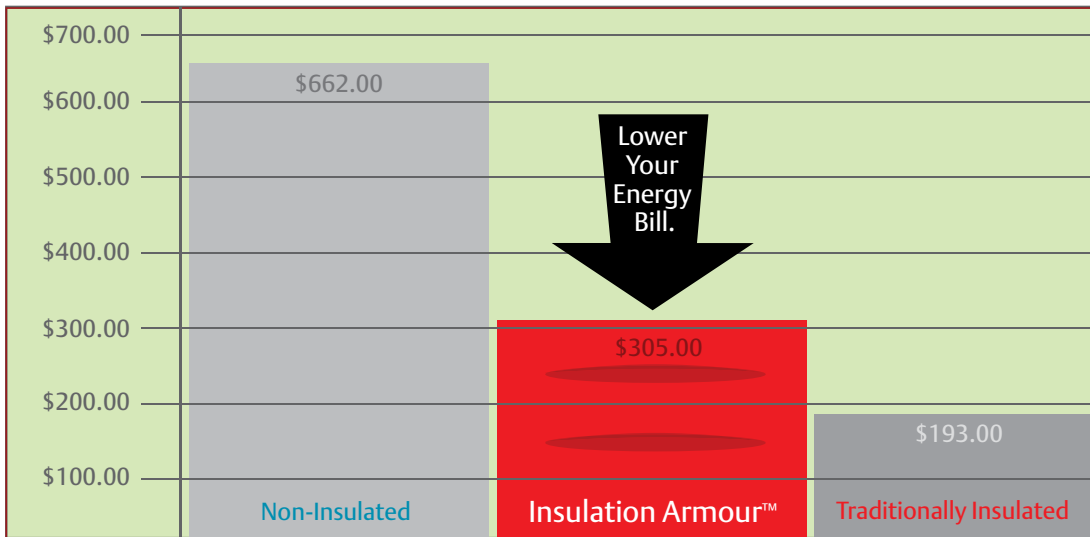

* Average annual energy cost based on \$.12 KWH electricity rate, 12 hours of daily use, 365 days a year. Energy cost and savings will vary depending on usage, electricity cost, and comparative model.

Colors

Insulation Armour is available in red, blue, or gray.



Removable Control Module

Entire module is removable without tools for easy cleaning and servicing. Three modules to choose from: holding, moisture holding, and combination proofing and holding.



Slides

Three systems to choose from that hold a variety of pan sizes: universal, lip load, fixed wire.

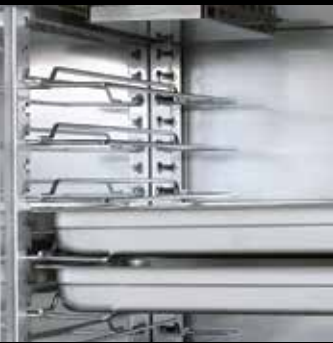

Doors

Field reversible, solid insulated or clear polycarbonate doors. Full-height cabinets available with full length or dutch doors.



Unique Design

Cool-to-touch design provides energy efficiency at a lower initial investment. Patented technology retains heat and saves energy!



Insulation Armour™

Durable polymer exterior insulates the cabinet and is dent, impact, and stain resistant. Molded-in hand holds create vertical handles for mobile applications.



3 SERIES CONTROL MODULES

THE OPTIONS YOU NEED TO KEEP YOU IN COMPLETE CONTROL

HOLDING MODULE

Heated holding only.



Electrical Configurations



NEMA 5-20P
120V, 60Hz, 2000W



NEMA 5-15P
120V, 60Hz, 1440W



NEMA 6-15P
220-240V, 50/60Hz, 1681-2000W

COMBINATION MODULE

Heated holding and proofing capabilities.



Electrical Configurations



NEMA 5-20P
120V, 60Hz, 2000W



NEMA 5-15P
120V, 60Hz, 1440W



NEMA 6-15P
220-240V, 50/60Hz, 1681-2000W

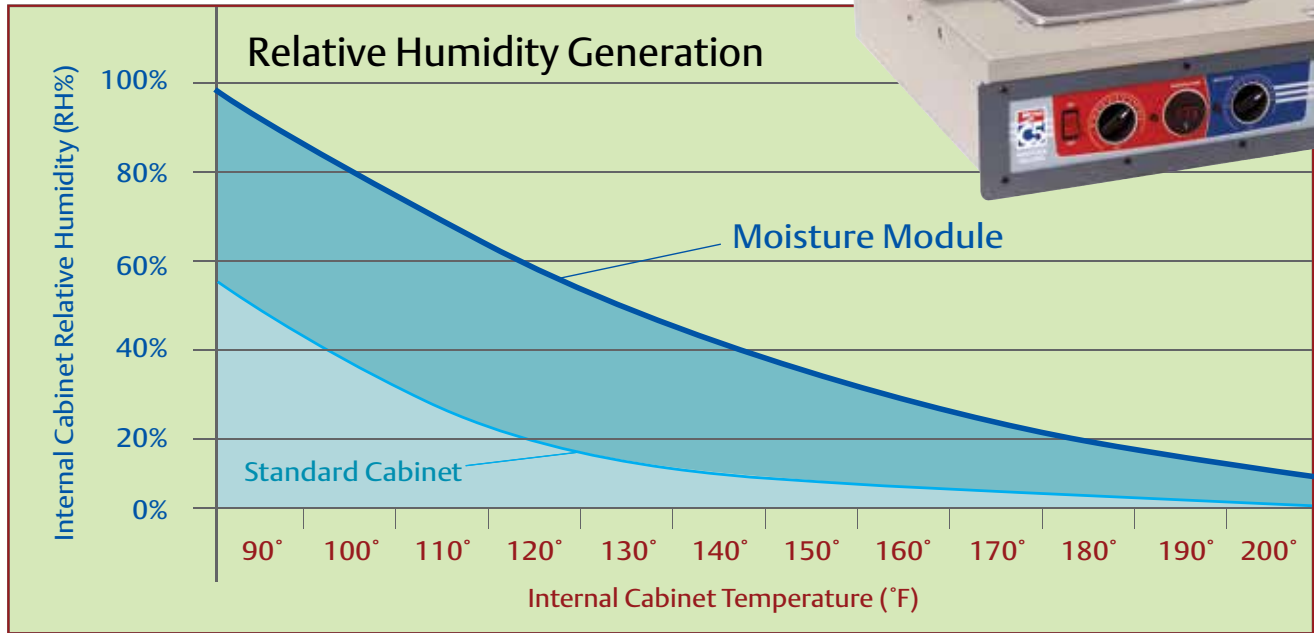

MOISTURE MODULE

Heated holding with moisture control and proofing capabilities.



Electrical Configurations



NEMA 5-20P
120V, 60Hz, 2000W



NEMA 6-15P
220-240V, 50/60Hz, 1681-2000W



The most important consideration when choosing a heated holding cabinet is the food. Many foods, in particular proteins, hold best in a moist environment. The Moisture Module option for the C5 3 Series delivers 5 times the moisture-generating power of a standard “dry” cabinet at a price far below that of conventional high-humidity alternatives. Metro delivers the ability to assure food safety and improve food quality in a “game changing” design. The Moisture Module inside an Insulation Armour cabinet is a one-of-a-kind product, and an unbelievable value!

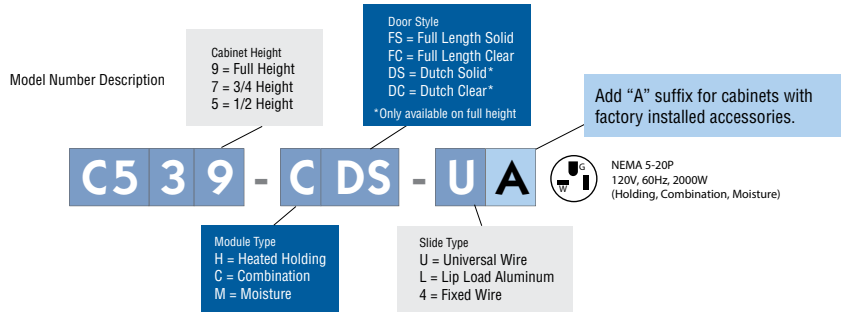

3 SERIES — {13.93}

WITH INSULATION

ARMOUR™

Add "L" or "X" for alternate electrical configurations (no upcharge)

C539-CLDS-U NEMA 5-15P
 120V, 60Hz, 1440W
 (Holding, Combination)

C539-CXDS-U NEMA 6-15P
 220-240V, 50/60Hz, 1681-2000W
 (Holding, Combination, Moisture)

Holding Module Cabinets

Doors	Slides	Approx. Pkd. Wt. (lbs.)	Red Cat. No.
Full Height			
Full Length Clear	Fixed Wire	248	C539-HFC-4
Full Length Clear	Universal	262	C539-HFC-U
Full Length Clear	Lip Load	257	C539-HFC-L
Full Length Solid			
Full Length Solid	Fixed Wire	268	C539-HFS-4
Full Length Solid	Universal	282	C539-HFS-U
Full Length Solid	Lip Load	277	C539-HFS-L
Dutch Clear			
Dutch Clear	Fixed Wire	250	C539-HDC-4
Dutch Clear	Universal	264	C539-HDC-U
Dutch Clear	Lip Load	259	C539-HDC-L
Dutch Solid			
Dutch Solid	Fixed Wire	270	C539-HDS-4
Dutch Solid	Universal	283	C539-HDS-U
Dutch Solid	Lip Load	278	C539-HDS-L

Doors	Slides	Approx. Pkd. Wt. (lbs.)	Red Cat. No.
3/4 Height			
Full Length Clear	Fixed Wire	173	C537-HFC-4
Full Length Clear	Universal	144	C537-HFC-U
Full Length Clear	Lip Load	178	C537-HFC-L
Full Length Solid			
Full Length Solid	Fixed Wire	173	C537-HFS-4
Full Length Solid	Universal	191	C537-HFS-U
Full Length Solid	Lip Load	186	C537-HFS-L
1/2 Height			
Full Length Clear	Fixed Wire	132	C535-HFC-4
Full Length Clear	Universal	138	C535-HFC-U
Full Length Clear	Lip Load	135	C535-HFC-L
Full Length Solid			
Full Length Solid	Fixed Wire	142	C535-HFS-4
Full Length Solid	Universal	150	C535-HFS-U
Full Length Solid	Lip Load	145	C535-HFS-L

3 Series cabinets ship with Red Insulation Armour, please add color designation if Blue (-BU) or Gray (-GY) is desired.

(ex. C539-CDS-U-BU or C539-CDS-U-BUA if with accessories)

Combination Module Cabinets

Doors	Slides	Approx. Pkd. Wt. (lbs.)	Red Cat. No.
Full Height			
Full Length Clear	Fixed Wire	248	C539-CFC-4
Full Length Clear	Universal	262	C539-CFC-U
Full Length Clear	Lip Load	257	C539-CFC-L
Full Length Solid	Fixed Wire	268	C539-CFS-4
Full Length Solid	Universal	282	C539-CFS-U
Full Length Solid	Lip Load	277	C539-CFS-L
Dutch Clear	Fixed Wire	250	C539-CDC-4
Dutch Clear	Universal	264	C539-CDC-U
Dutch Clear	Lip Load	259	C539-CDC-L
Dutch Solid	Fixed Wire	270	C539-CDS-4
Dutch Solid	Universal	283	C539-CDS-U
Dutch Solid	Lip Load	278	C539-CDS-L

Doors	Slides	Approx. Pkd. Wt. (lbs.)	Red Cat. No.
3/4 Height			
Full Length Clear	Fixed Wire	173	C537-CFC-4
Full Length Clear	Universal	144	C537-CFC-U
Full Length Clear	Lip Load	178	C537-CFC-L
Full Length Solid	Fixed Wire	173	C537-CFS-4
Full Length Solid	Universal	191	C537-CFS-U
Full Length Solid	Lip Load	186	C537-CFS-L
1/2 Height			
Full Length Clear	Fixed Wire	132	C535-CFC-4
Full Length Clear	Universal	138	C535-CFC-U
Full Length Clear	Lip Load	135	C535-CFC-L
Full Length Solid	Fixed Wire	142	C535-CFS-4
Full Length Solid	Universal	150	C535-CFS-U
Full Length Solid	Lip Load	145	C535-CFS-L

Moisture Module Cabinets

Doors	Slides	Approx. Pkd. Wt. (lbs.)	Red Cat. No.
Full Height			
Full Length Clear	Fixed Wire	248	C539-MFC-4
Full Length Clear	Universal	262	C539-MFC-U
Full Length Clear	Lip Load	257	C539-MFC-L
Full Length Solid	Fixed Wire	268	C539-MFS-4
Full Length Solid	Universal	282	C539-MFS-U
Full Length Solid	Lip Load	277	C539-MFS-L
Dutch Clear	Fixed Wire	250	C539-MDC-4
Dutch Clear	Universal	264	C539-MDC-U
Dutch Clear	Lip Load	259	C539-MDC-L
Dutch Solid	Fixed Wire	270	C539-MDS-4
Dutch Solid	Universal	283	C539-MDS-U
Dutch Solid	Lip Load	278	C539-MDS-L

Doors	Slides	Approx. Pkd. Wt. (lbs.)	Red Cat. No.
3/4 Height			
Full Length Clear	Fixed Wire	173	C537-MFC-4
Full Length Clear	Universal	144	C537-MFC-U
Full Length Clear	Lip Load	178	C537-MFC-L
Full Length Solid	Fixed Wire	173	C537-MFS-4
Full Length Solid	Universal	191	C537-MFS-U
Full Length Solid	Lip Load	186	C537-MFS-L
1/2 Height			
Full Length Clear	Fixed Wire	132	C535-MFC-4
Full Length Clear	Universal	138	C535-MFC-U
Full Length Clear	Lip Load	135	C535-MFC-L
Full Length Solid	Fixed Wire	142	C535-MFS-4
Full Length Solid	Universal	150	C535-MFS-U
Full Length Solid	Lip Load	145	C535-MFS-L



Universal Slides



Lip Load Slides



Fixed Wire Slides

Cabinet Size	Universal Wire Pan Capacity							Lip Load Pan Capacity		Fixed Wire Pan Capacity			
	Slide Pairs		Sheet Pans	Steam Pans			Gastronorm 65mm Depth		Sheet Pans	Sheet Pans	Steam Pans	Gastronorm 65mm Depth	
	Provided	Max*	18"x26"	12"x20"x2.5"	12"x20"x4"	12"x20"x6"	2/1	1/1	18"x26"	18"x26"	12"x20"x2.5"	2/1	1/1
Full Height	18	36	18	34	24	14	17	34	35	18	34	17	34
Full Height Dutch	18	35	17	32	22	12	16	32	34	17	32	16	32
3/4 Height	14	28	14	26	16	10	13	26	27	14	26	13	26
1/2 Height	8	17	8	16	10	6	8	16	17	8	16	8	16

*Maximum number of slide pairs @ 1 1/2" spacing. Additional slide pairs ordered separately.



C5 1 Series

Non-insulated holding and proofing cabinets.

Reliable performance for proofing and basic holding needs.



Available Sizes

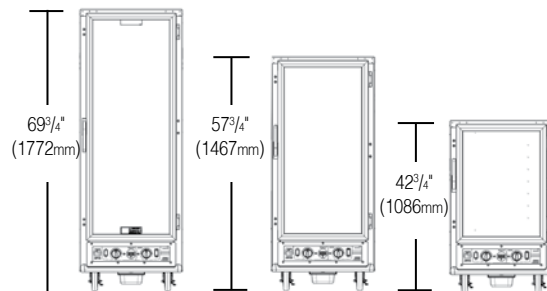

All cabinets are 25¹/₈" (638mm) wide and 30¹/₄" (768mm) deep (aluminum construction).

3 Removable Control Modules to choose from.

Entire module is removable without tools for easy cleaning and servicing. Choose from: holding, proofing, or combination proofing and holding.



Universal Slides
Maximum flexibility to hold 12x20 steam, 18x26 sheet, and GN pans.



Lip Load Slides
Maximize 18x26 sheet pan capacity.



Fixed Wire
Spaced on 3" centers to hold 12x20x2.5 steam, 18x26 sheet, and GN pans (65mm deep).



Shelf Option
For covered plates or odd size pans and dishes.

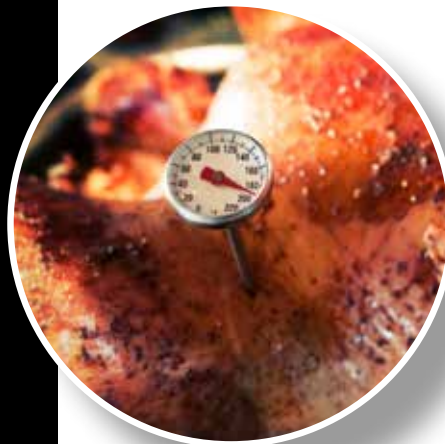

HOLDING MODULE: Heated holding only.



Electrical Configurations



NEMA 5-20P
120V, 60Hz, 2000W



NEMA 6-15P
220-240V, 50/60Hz, 1681-2000W

PROOFING MODULE: Proofing only.



Electrical Configurations



NEMA 5-15P
120V, 60Hz, 1440W



NEMA 6-15P
220-240V, 50/60Hz, 1210-1440W

COMBINATION MODULE: Heated holding & proofing.



Electrical Configurations



NEMA 5-20P
120V, 60Hz, 2000W



NEMA 6-15P
220-240V, 50/60Hz, 1681-2000W

Clear Door

Clear polycarbonate doors provide visibility of the contents inside the cabinet without the heat loss associated with opening the door.



More Power for Food Safety

2000 watt power for increased performance and food safety in holding applications.



1 SERIES — {13.91}

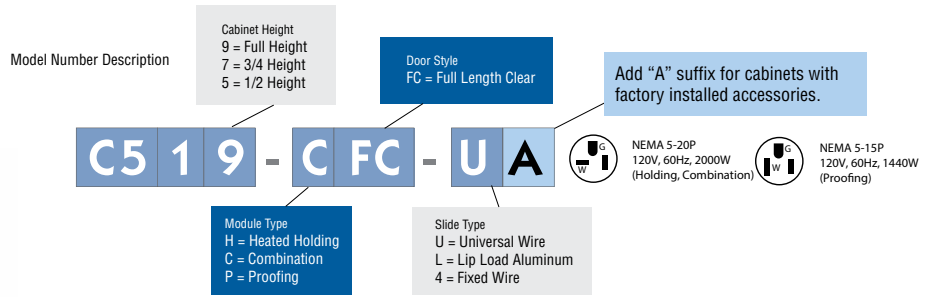

Add "X" for alternate electrical configurations (no upcharge)

C519-CXFC-U  NEMA 6-15P
220-240V, 50/60Hz, 1681-2000W (Holding, Combination)
220-240V, 50/60Hz, 1210-1440W (Proofing)

Doors	Slides	Module	Cat. No.	Approx. Pkd. Wt. (lbs.)
Full Height				
Full Length Clear	Fixed Wire	Combination	C519-CFC-4	197
Full Length Clear	Universal	Combination	C519-CFC-U	211
Full Length Clear	Lip Load	Combination	C519-CFC-L	206
Full Length Clear	Fixed Wire	Holding	C519-HFC-4	197
Full Length Clear	Universal	Holding	C519-HFC-U	211
Full Length Clear	Lip Load	Holding	C519-HFC-L	206
Full Length Clear	Fixed Wire	Proofing	C519-PFC-4	197
Full Length Clear	Universal	Proofing	C519-PFC-U	211
Full Length Clear	Lip Load	Proofing	C519-PFC-L	206
3/4 Height				
Full Length Clear	Fixed Wire	Combination	C517-CFC-4	130
Full Length Clear	Universal	Combination	C517-CFC-U	139.5
Full Length Clear	Lip Load	Combination	C517-CFC-L	135
Full Length Clear	Fixed Wire	Holding	C517-HFC-4	130
Full Length Clear	Universal	Holding	C517-HFC-U	139.5
Full Length Clear	Lip Load	Holding	C517-HFC-L	130
Full Length Clear	Fixed Wire	Proofing	C517-PFC-4	130
Full Length Clear	Universal	Proofing	C517-PFC-U	139.5
Full Length Clear	Lip Load	Proofing	C517-PFC-L	135
1/2 Height				
Full Length Clear	Fixed Wire	Combination	C515-CFC-4	98
Full Length Clear	Universal	Combination	C515-CFC-U	104
Full Length Clear	Lip Load	Combination	C515-CFC-L	101
Full Length Clear	Fixed Wire	Holding	C515-HFC-4	98
Full Length Clear	Universal	Holding	C515-HFC-U	104
Full Length Clear	Lip Load	Holding	C515-HFC-L	101
Full Length Clear	Fixed Wire	Proofing	C515-PFC-4	104
Full Length Clear	Universal	Proofing	C515-PFC-U	98
Full Length Clear	Lip Load	Proofing	C515-PFC-L	101



Universal Slides



Lip Load Slides



Fixed Wire Slides

Cabinet Size	Universal Wire Pan Capacity							Lip Load Pan Capacity		Fixed Wire Pan Capacity			
	Slide Pairs		Sheet Pans	Steam Pans			Gastronorm 65mm Depth		Sheet Pans	Sheet Pans	Sheet Pans	Gastronorm 65mm Depth	
	Provided	Max*	18"x26"	12"x20"x2.5"	12"x20"x4"	12"x20"x6"	2/1	1/1	18"x26"	18"x26"	12"x20"x2.5"	2/1	1/1
Full Height	18	36	18	34	24	14	17	34	35	18	34	17	34
3/4 Height	14	28	14	26	16	10	13	26	27	14	26	13	26
1/2 Height	8	17	8	16	10	6	8	16	17	8	16	8	16

*Maximum number of slide pairs @ 1 1/2" spacing. Additional slide pairs ordered separately.

C5 3 & 1 SERIES ACCESSORIES

1 Series Rear Push Handle

Stainless steel tubular handle mounted to the back of the cabinet.

Description	Cat. No.
Rear Push Handle*	C5-RHANDLE

* Not available on 3 Series cabinets.



1 Series Rear Push Handle

Bumper Option

Description	Cat. No.
Full Perimeter Bumper	C5-PERMBUMP-1

Note: 3 Series cabinets come standard with full body bumper



Polymer Corner Bumper

Door, Plug & Caster Options

Description	Cat. No.
Flush Door Latch*	C5-LATCHFLUSH-1
Travel Latch	C5-TRVL
Factory Left Hand Door Hinging	DD3768
Straight Plug (20 Amp, 120V) — in lieu of standard**	C5-STRPLG-20
Straight Plug (15 Amp, 120V) — in lieu of standard**	C5-STRPLG-15
5" Rear Rigid Casters (pair) — in lieu of standard	C5-5RDGCSTR
6" Casters (set of 4 swivel) — in lieu of standard	C5-6CASTER
6" Stainless Steel Legs (set of 4) — in lieu of casters	C5-SSLEGS

*Note: Order (1) per door (ie — dutch door models require 2 ea.)

**Note: 3,1 Series 120V units come standard with right angle plug, straight plug standard on 220-240V units



C5-LATCHFLUSH-1



Right Angle Plug



Straight Plug

Slide & Shelf Options

Description	Cat. No.
Extra Universal Slide Pair (2 pieces) Chrome	C5-USLIDEPR-C
Extra Universal Slide Pair (2 pieces) Stainless Steel	C5-USLIDEPR-S
Full Height Stainless Steel Universal Slide Upgrade*	C5-USLIDE-9S
3/4 Height Stainless Steel Universal Slide Upgrade*	C5-USLIDE-7S
1/2 Height Stainless Steel Universal Slide Upgrade*	C5-USLIDE-5S
Small Item Shelf**	C5-SHELF-S
(4) Wire Shelves in Lieu of Universal Slides (full height models)*	C5-SHELFONLY-9S
(3) Wire Shelves in Lieu of Universal Slides (3/4 height models)*	C5-SHELFONLY-7S
(2) Wire Shelves in Lieu of Universal Slides (1/2 height models)*	C5-SHELFONLY-5S

*Note: Must order universal slide model ("U")

**Note: Can only be used with universal slides ("U"). Does not work with lip-load slides



Small Item Shelf



Universal Slide

Everyday E-ffordability.



C5 E-Series

Non-insulated holding & proofing cabinets.

Metro's value driven C5® E-Series design provides the right mix of features to economically hold & proof in the same cabinet. Universal slides accommodate a variety of pans and higher power output assures food stays hot, safe, and appetizing. C5 E-Series is a winning combination of the best features, the right price, and top-quality US made construction!

Dimensions

71.4" H (1814mm) x 25.8" W (655mm)
x 29.6" D (751mm)

Cabinets

Electrical	Cat No.	Approx. Pkd. Wt. (lbs.)
120V, 60Hz	C5E9-CFC-U	151
220-240V, 50/60Hz	C5E9-CXFC-U	150

Accessories (Ship Separately)

Description	Cat. No.
Small Item Shelf	C5-SHELF-S
Universal Slide Pair (Chrome)	C5-USLIDEPR-C



C5 E-Series

Non-insulated holding & proofing cabinets.

Metro's value driven C5® E-Series design provides the right mix of features to economically hold & proof in the same cabinet. Universal slides accommodate a variety of pans and higher power output assures food stays hot, safe, and appetizing. C5 E-Series is a winning combination of the best features, the right price, and top-quality US made construction!

Dimensions

71.4" H (1814mm) x 25.8" W (655mm)
x 29.6" D (751mm)



2000 Watts

More power for food safety.

2000 watt power for increased performance and food safety in holding applications.

Pan Capacities

Slide Pairs	Sheet Pans	Steam Pans				Gastronorm					
		12"x20"x2.5"	12"x20"x4"	12"x20"x6"		65mm Depth		100mm Depth		150mm Depth	
Provided	Max	18"x26"	12"x20"x2.5"	12"x20"x4"	12"x20"x6"	2/1	1/1	2/1	1/1	2/1	1/1
12	35	12*	24*	24	14	12*	24*	12	24	7	14

Note: Maximum number of slide pairs @ 1.5" spacing. Additional slide pairs ordered separately.
* With additional slide pairs, can accommodate up to: (35) 18x26, (36) 12x20x2.5 or GN 1/1 65mm, (18) GN 2/1 65mm



Cabinets



Electrical	Cat No.	Approx. Pkd. Wt. (lbs.)
120V, 60Hz	C5E9-CFC-U	151
220-240V, 50/60Hz	C5E9-CXFC-U*	150

* Not eligible for Quick Ship.

Accessories (Ship Separately)

Description	Cat. No.
Small Item Shelf	C5-SHELF-S
Universal Slide Pair (Chrome)	C5-USLIDPR-C



All T-Series models are ENERGY STAR.



C5 T-Series with Transport Armour™

Heavy-duty heated transport cabinets built for over-the-road applications.

Foamed-in-place polyurethane insulation provides SUPERIOR heat retention and structural rigidity. While unplugged and in transit, an available mobile power option gently circulates air inside the cabinet, eliminating hot and cold spots that endanger food safety. The durability, efficiency, and intelligence of the T-Series make it the IDEAL solution for all mobile applications.

Available Sizes

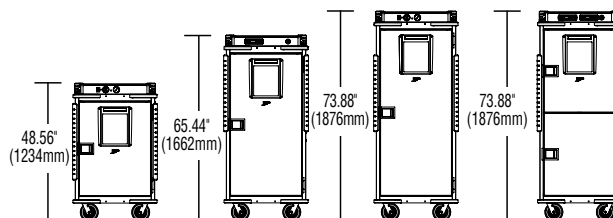

All cabinets are 30" (762mm) wide and 39.25" (997mm) deep.



Ergonomic Handles and Bumpers

Steel reinforced polymer handles that double as bumpers; protect the cabinet from impact; and provide ergonomic grab points for easy handling while pushing, pulling, and crossing thresholds.



Rigid Door
Foamed-in-place vaulted door for maximum structural integrity. 11-gauge stainless steel hinges, flush paddle latch, and multi-functional information panel.



Slides
Three systems to choose from to hold a variety of pan sizes. Heavy-duty extrusions designed for transport.



Armour Panels
Polymer panels are optimally located to protect the cabinet from facility hazards. Molded-in hand holds create additional grab points.



Mobile Power
Battery powered fan that gently circulates air for superior stratification while cabinet is unplugged and in transit (digital version Only).



Intelligent or Basic Controls

Digital control option with mobile power gently circulates air in cabinet and provides temperature alerts while unplugged and in transit!



Heavy-Duty

One piece base bolted to heavy-duty caster channels, reinforced with foamed-in-place polyurethane insulation provides superior rigidity and durability.

Keeps Food Hot for
5 Hours
or Longer.



Uses
50% Less
Energy
than leading fiberglass insulated cabinets!



Foamed-in-Place Insulation

Stainless steel structure with foamed-in-place polyurethane insulation provides superior heat retention and energy efficiency.

Uses 50% Less Energy.

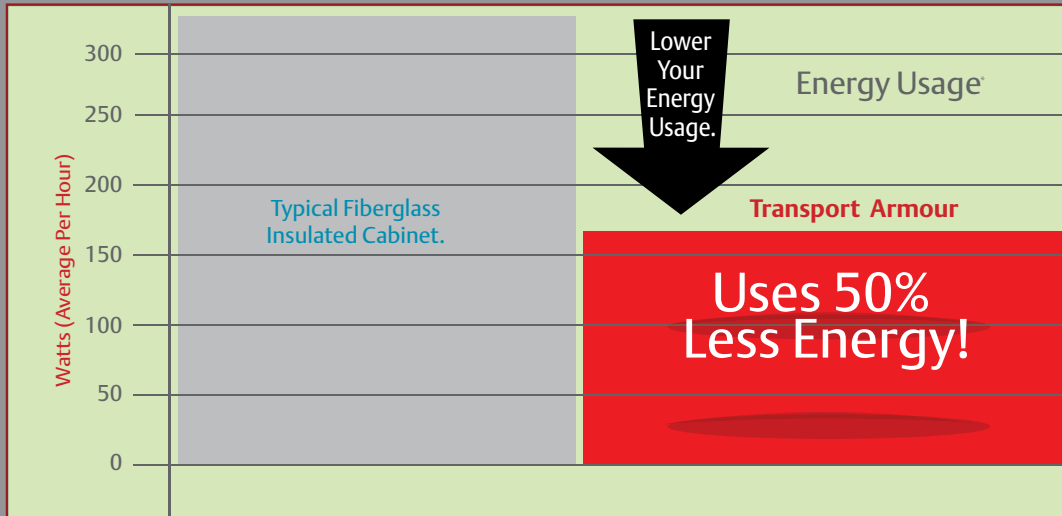

* Average hourly energy consumption. Based off ENERGY STAR Qualification, "Idle Energy, Rate-Dry" test. 150°F cabinet operating temperature. Based off full-height cabinet models.

With Energy costs on the rise, reducing energy usage is becoming more and more important. T-Series with Transport Armour™ utilizes 50% less Energy than the most efficient fiberglass insulated cabinets. Foamed-in-place polyurethane insulation delivers both Efficiency

Uniform Temperature...

T-Series with Transport Armour™

Gentle circulation of air, while unplugged and in transit, eliminates hot and cold spots that endanger food safety. Temperature stratification is 3½ times better with Metro's mobile power option.

To prolong battery life, air circulation and display will shut down after 3 hours. Simply turn unit back on if additional runtime is needed.



- 154 °F
- 153 °F
- 153 °F
- 152 °F
- 150 °F

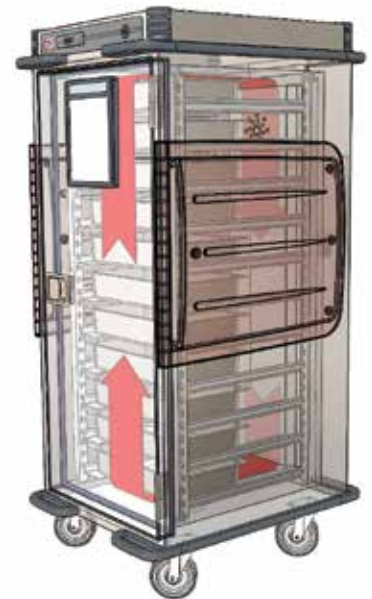

Digital Display

Low/High Temp Alarms

Mobile Power



Recall Memory

Diagnostic Troubleshooting

Keeps Food Hot Twice As Long.

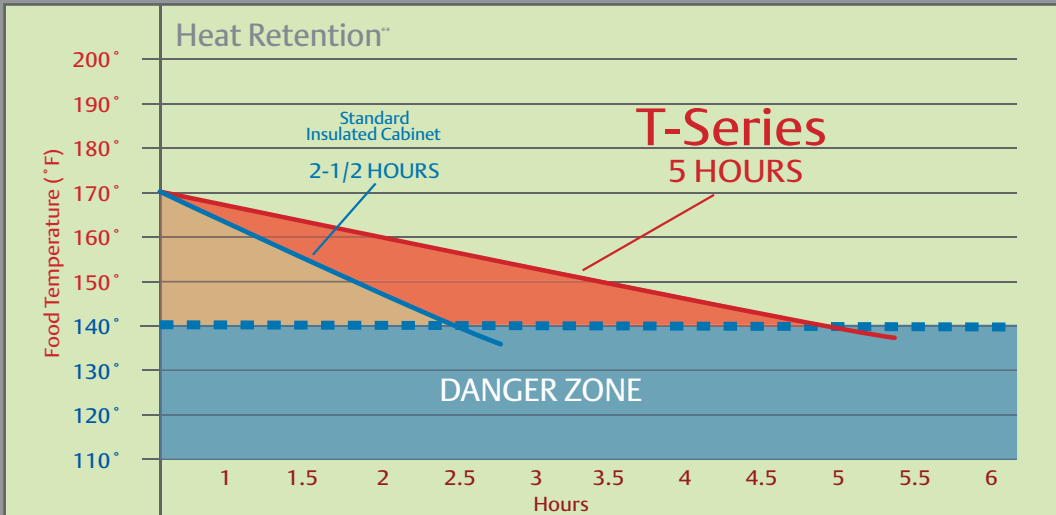

** Average food temperature 170° F, cabinets preheated to 180°F. Four 12" x 20" x 4" uncovered steam pans were placed inside cabinets. Additional food mass and covered pans may result in longer heat retention.

while unplugged.

Traditional Cabinet

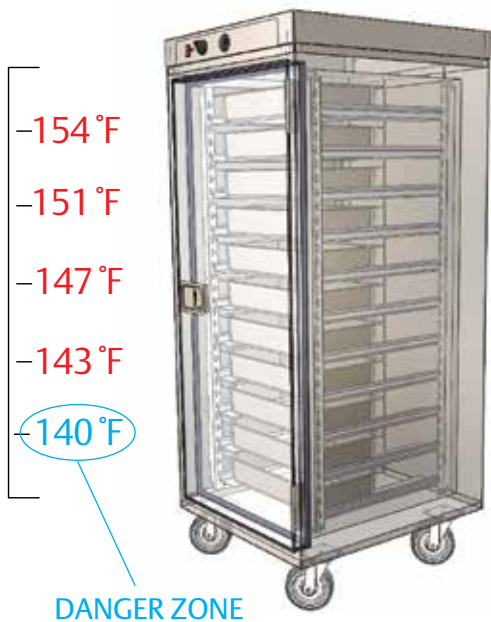

The number one consideration when transporting hot food to satellite locations is keeping food hot, appetizing, and out of the danger zone. Heat retention plays a vital role in the success of any meal delivery program. T-Series' foamed-in-place polyurethane insulation keeps food hot while unplugged for **5 hours or longer**, which is more than twice as long as a standard cabinet with fiberglass insulation. Schools, institutions, banquet facilities, and caterers, just to name a few — can now Travelsafe™ with Transport Armour™.

Experience the Benefits.
Keep Food Safe.

T-Series

with Transport Armour™

Electro-Mechanical Temperature Control

Analog Thermometer



Flush Recessed Controls



Use small item shelf option for plated meals or odd sized pans.

T-SERIES — {13.9T}

WITH TRANSPORT
ARMOUR™

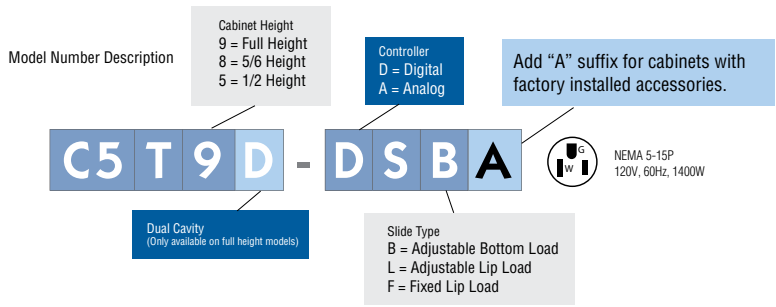

Add "X" for alternate electrical configurations (no upcharge)



Controls	Slides	Cat No.	Approx. Pkd. Wt. (lbs.)
Full Height			
Digital	Adjustable Bottom Load	C5T9-DSB	490
Digital	Adjustable Lip Load	C5T9-DSL	482
Digital	Fixed Lip Load	C5T9-DSF	437
Analog	Adjustable Bottom Load	C5T9-ASB	484
Analog	Adjustable Lip Load	C5T9-ASL	476
Analog	Fixed Lip Load	C5T9-ASF	431
Full Height Dual Cavity			
Digital	Adjustable Bottom Load	C5T9D-DSB	509
Digital	Adjustable Lip Load	C5T9D-DSL	502
Digital	Fixed Lip Load	C5T9D-DSF	461
Analog	Adjustable Bottom Load	C5T9D-ASB	503
Analog	Adjustable Lip Load	C5T9D-ASL	496
Analog	Fixed Lip Load	C5T9D-ASF	455
5/6 Height			
Digital	Adjustable Bottom Load	C5T8-DSB	456
Digital	Adjustable Lip Load	C5T8-DSL	449
Digital	Fixed Lip Load	C5T8-DSF	404
Analog	Adjustable Bottom Load	C5T8-ASB	450
Analog	Adjustable Lip Load	C5T8-ASL	443
Analog	Fixed Lip Load	C5T8-ASF	398
1/2 Height			
Digital	Adjustable Bottom Load	C5T5-DSB	383
Digital	Adjustable Lip Load	C5T5-DSL	378
Digital	Fixed Lip Load	C5T5-DSF	337
Analog	Adjustable Bottom Load	C5T5-ASB	377
Analog	Adjustable Lip Load	C5T5-ASL	372
Analog	Fixed Lip Load	C5T5-ASF	331

All 120V models with and without accessories are ENERGY STAR.



Adjustable Bottom Load Slides

Cabinet Size	Adjustable Bottom Load Pan Capacity							
	Slide Pairs		Sheet Pans	Steam Pans			Gastronorm 65mm Depth	
	Provided	Max**	18"x26"	12"x20"x2.5"	12"x20"x4"	12"x20"x6"	2/1	1/1
Full Height	16	32	16	32	22	16	16	32
Full Height Dual Cavity	14	28	14	32*	20*	16*	16*	32*
5/6 Height	14	27	14	28	18	14	14	28
1/2 Height	9	17	9	18	12	8	9	18

*Floor of cabinet used for one pan level, two levels for dual cavity.

**Maximum number of slide pairs @ 1.675" spacing. Additional slide pairs ordered separately.



Adjustable Lip Load Slides

Cabinet Size	Adjustable Lip Load Pan Capacity							
	Slide Pairs		Sheet Pans	Steam Pans			Gastronorm 65mm Depth	
	Provided	Max**	18"x26"	12"x20"x2.5"	12"x20"x4"	12"x20"x6"	2/1	1/1
Full Height	16	32	16	32	22*	16	16	32
Full Height Dual Cavity	14	28	14	28	20*	12	14	28
5/6 Height	14	27	14	26	18	12	13	26
1/2 Height	9	17	9	16	12*	8	8	16

*Floor of cabinet used for one pan level, two levels for dual cavity.

**Maximum number of slide pairs @ 1.675" spacing. Additional slide pairs ordered separately.



Fixed Lip Load Slides

Cabinet Size	Slide Levels	Fixed Lip Load								
		Steam Pans			65mm Depth		Gastronorm			
		12"x20"x2.5"	12"x20"x4"	12"x20"x6"	2/1	1/1	100mm Depth	150mm Depth	2/1	1/1
Full Height	32	32	22	16	16	32	11	22	8	16
Full Height Dual Cavity	30	32	20	16	16	32	10	20	8	16
5/6 Height	27	28	18	14	14	28	9	18	7	14
1/2 Height	17	18	12	8	9	18	6	12	4	8

ACCESSORIES

Door, Plug, Caster Options

Description	Cat. No.
Travel Latch/Hasp	C5T-TRVL
Coiled Cord with Straight Plug (120V, 15 Amp) — in Lieu of Standard	C5T-STRPLG
6" Rear Rigid Casters (pair) — in Lieu of Standard	C5T-6RDGCSTR
8" Semi-Pneumatic Style Casters — in Lieu of Standard	C5T-8SEMPNEU



C5T-TRVL

Correctional Packages

Includes Lockable Control Panel Cover, Lockable Travel Latch/Hasp, Tamper Proof Screws on Exterior (Padlock NOT included)

Description	Cat. No.
Correctional Package for Dual Cavity Cabinet*	C5T-CORR-9D
Correctional Package for Full Height Cabinet	C5T-CORR-9
Correctional Package for 5/6 Height Cabinet	C5T-CORR-8
Correctional Package for 1/2 Height Cabinet	C5T-CORR-5

*Note: Includes (2) Lockable Travel Latch / Hasps



Correctional Package

Slide And Shelf Options

Description	Cat. No.
Adjustable Bottom Load Slide Pair (2 pieces)	C5T-BSLIDEPR
Adjustable Lip Load Slide Pair (2 pieces)	C5T-LSLIDEPR
Small Item Shelf*	C5T-SHELF
(4) Wire Shelves — in Lieu of Adjustable Slides (full height/dual cavity models)**	C5T-SHELFONLY-9
(3) Wire Shelves — in Lieu of Adjustable slides (5/6 height models)**	C5T-SHELFONLY-8
(2) Wire Shelves — in Lieu of Adjustable Slides (1/2 height models)**	C5T-SHELFONLY-5

*Note: Can only be used with adjustable slides ("B" or "L"). Does not work with fixed lip-load slides

**Note: Must order adjustable slide model ("B" or "L").



Small Item Shelf



C5 R-Series with Refrigeration Armour™

**Heavy-duty mobile refrigerators.
Built for transport.**

Engineered to withstand the shock and vibration associated with mobile applications. Stainless steel construction with foamed-in-place polyurethane insulation provides superior rigidity and improved energy efficiency versus common fiberglass construction.

Dimensions

70¹/₈" H (1782mm) x 30" W (762mm) x 39¹/₄" D (997mm)



Well Protected

Protection of the refrigeration system in mobile applications is essential. C5 R-Series features an all-in-one, easily removable refrigeration cassette mounted on vibration / shock isolators for complete refrigeration system protection.



Rigid Door

Foamed-in-place vaulted door for maximum structural integrity. 11-gauge stainless steel hinges and multi-functional information panel.



Slides

Three systems to choose from to hold a variety of pan sizes. Heavy-duty extrusions designed for transport.



Door Latch

Flush mounted, heavy-duty stainless steel paddle latch provides protection during transport.



Wire Shelf Option

Configurable with wire shelves to hold plated meals or odd sized pans and dishes.



Rear Push Handle Option for added control

Easy to move

Stylish, durable armour panels with built-in vertical handles provide protection from impact and ergonomic grab points for easy handling.

Versatile

Perfect for banquet/catering applications that require transport of chilled food to serving locations. Also great for instant back-up capacity in cafeterias and buffet areas.





Model Number Description

Add "A" suffix for cabinets with factory installed accessories.

C5 R 9 - S B A

 NEMA 5-15P
120V, 5.4A, 60Hz

Slide Type
B = Adjustable Bottom Load
L = Adjustable Lip Load
F = Fixed Lip Load

Add "X" for alternate electrical configurations (no upcharge)

C5R9X-SB  NEMA 6-15P
220-240V, 2.7A, 50Hz

R-SERIES — {13.9R}
WITH REFRIGERATION
ARMOUR™

Electrical	Slides	Cat No.	Approx. Pkd. Wt. (lbs.)
120V, 60Hz	Adjustable Bottom Load	C5R9-SB	490
120V, 60Hz	Adjustable Lip Load	C5R9-SL	483
120V, 60Hz	Fixed Lip Load	C5R9-SF	438
220-240V, 50Hz	Adjustable Bottom Load	C5R9X-SB	490
220-240V, 50Hz	Adjustable Lip Load	C5R9X-SL	483
220-240V, 50Hz	Fixed Lip Load	C5R9X-SF	438



Adjustable Bottom Load Slides



Adjustable Lip Load Slides



Fixed Lip Load Slides

Slide Type	Pan Capacity											
	Slide Pairs		Sheet Pans	Steam Pans			65mm Depth		Gastronorm 100mm Depth		150mm Depth	
	Provided	Max**	18"x26"	12"x20"x2.5"	12"x20"x4"	12"x20"x6"	2/1	1/1	2/1	1/1	2/1	1/1
Adjustable Bottom Load	13	25*	13**	26	18	12	13	26	9	18	6	12
Adjustable Lip Load	13	25*	13**	24	16	12	12	24	8	16	6	12
Fixed lip Load	26	26	N/A	26	16	12	13	26	8	16	6	12

*Maximum number of slide pairs @ 1.65" spacing. Additional slide pairs ordered separately.
 **Standard capacity @ 3.3" spacing. Increased capacity requires additional slide pairs.

ACCESSORIES

Door, Plug, Rear Handle, Caster Options

Description	Cat. No.
Travel Latch / Hasp	C5T-TRVL
Interior Door Release*	C5R-INTDR
Straight Plug (120V, 15 Amp) — in lieu of standard	C5-STRPLG-15
Rear Push Handle (U-Shaped)	C5-UHANDLE
6" Rear Rigid Casters (pair) — in lieu of standard	C5T-6RDGCSTR
8" Semi-Pneumatic Style Casters (in lieu of standard)	C5T-8SEMPNEU

*Note: Required for cabinets sold in Canada.



C5T-TRVL

Correctional Packages

Includes/thermometer Cover, Lockable Travel Latch/Hasp, Tamper Proof Screws on Exterior (Padlock NOT included)

Description	Cat. No.
Correctional Package	C5R-CORR-9

Slide And Shelf Options

Description	Cat. No.
Adjustable Bottom Load Slide Pair (2 pieces)	C5T-BSLIDEPR
Adjustable Lip Load Slide Pair (2 pieces)	C5T-LSLIDEPR
Small Item Shelf*	C5T-SHELF
(3) Wire Shelves in Lieu of Adjustable Slides (full height model)**	C5R-SHELFONLY-9

*Note: Can only be used with adjustable slides ("B" or "L"). Does not work with fixed lip-load slides

**Note: Must order adjustable slide model ("B" or "L").



PLATED MEAL CAPACITY

with shelf option (C5R-SHELFONLY-9)

Plate Cover Diameter	Covered Plate Height						
	2.5" (63mm)	2.75" (69mm)	3" (76mm)	3.25" (82mm)	3.5" (88mm)	3.75" (95mm)	4" (101mm)
	15 levels	14 levels	13 levels	12 levels	11 levels	10 levels	10 levels
Up to 9" (228mm) — 6 per level	90	84	78	72	66	60	60
9.125" to 10" (229 to 254mm) — 5 per level	75	70	65	60	55	50	50
10.125" to 11.75" (255 to 298mm) — 4 per level	60	56	52	48	44	40	40
11.875" to 12.75" (299 to 323mm) — 3 per level	45	42	39	36	33	30	30
12.875" to 14.75" (324 to 374mm) — 2 per level	30	28	26	24	22	20	20

Shelf spacing for 2.5" (63mm), 2.75" (69mm), 3.25" (82mm), 3.5" (88mm) covered plate heights — (bottom in notch #1, middle in notch #10, top in notch #19).

Shelf spacing for 3" (76mm), 3.75" (95mm), 4" (101mm) covered plate heights — (bottom in notch #1, middle in notch #9, top in notch #17).



Quad-Heat™ unit shown with optional
Swing-Up Pull Handle.



MBQ

**Heated banquet cabinets that
put you in control of time,
temperature, and taste.**

Engineered to withstand the heavy-duty use
and abuse of the real world, while offering
one-of-a-kind tools to help improve your operation.

Rugged

Heavy-duty welded, reinforced, stainless steel construction with fiberglass insulation.



Intelligent, Ergonomic Features

Unique features like white board information panel, ergonomic handles, and hands-free kick latch provide the tools you need for improved efficiency and maneuverability.

Unique Canned Fuel System

Available Quad-Heat™ dual fuel system combines the standard heating module with a canned fuel back up system, utilizing corner chimneys to evenly distribute heat and eliminate “hot spots” commonly caused by ordinary canned fuel systems.

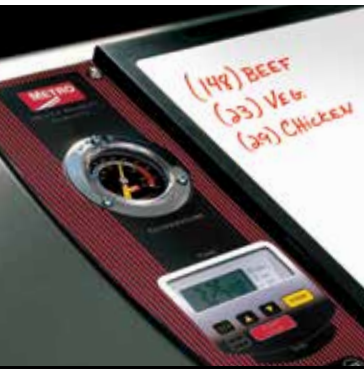
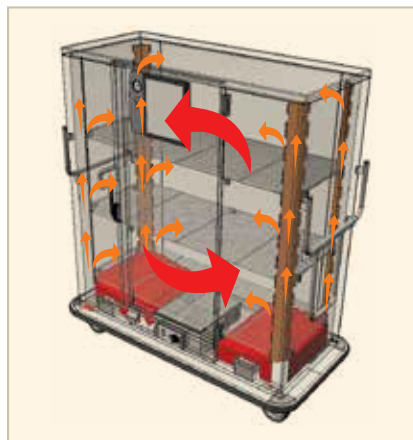

Information Panel
Dry-erase white board doubles as a clip board. Integrated thermometer and timer help you keep track time and temperature, all in one convenient place.



Kick Latch
Hands-free access to the cabinet when your hands are full.



Handles
Three-point control handles give you control to move the cabinet from all sides.



Removable Module
Entire module is removable for easy cleaning and servicing.

Two-door Banquet Cabinets — {13.32}

Two-door cabinets offer maximum accessibility, come with either standard electric or Quad-Heat™ thermal systems, and are designed to hold 11¾" (298mm) diameter covered plates. Covered plates up to 12¾" (324mm) diameter can be held in smaller quantities. Full-size sheet pans can be held front-to-back in two-door cabinets.



NEMA 5-15P
120V, 60Hz, 1650W



NEMA 6-15P
220V, 50/60Hz, 1650W



Quad-Heat™ unit shown with optional Swing-Up Pull Handle.

Two-Door Banquet Cabinets

Thermal System	11¾" Plate Capacity		12¾" Plate Capacity Stacked	Covered Plates Stacked High	Shelf Size (in.)	Shelves	Shelf Clearance (in.)	Height/Depth/Width (in.)	Shipping Weight (lbs.)	Cat. No.
	Stacked	Open Carrier								
Standard	200*	200	160	5	59x24	4	14	75.0x33.375x67.25	633	MBQ-200D
Quad-Heat	200*	200	160	5	59x24	4	14	75.0x33.375x67.25	668	MBQ-200D-QH
Standard	180*	180	150	6	59x24	3	17	69.5x33.375x67.25	595	MBQ-180D
Quad-Heat	180*	180	150	6	59x24	3	17	69.5x33.375x67.25	630	MBQ-180D-QH
Standard	150*	150	120	5	59x24	3	14	60.5x33.375x67.25	531	MBQ-150D
Quad-Heat	150*	150	120	5	59x24	3	14	60.5x33.375x67.25	566	MBQ-150D-QH
Standard	120*	120	100	6	59x24	2	17	52.0x33.375x67.25	483	MBQ-120D
Quad-Heat	120*	120	100	6	59x24	2	17	52.0x33.375x67.25	518	MBQ-120D-QH

*Capacities based on maximum cover diameter of 11¾" (298mm), plate and cover height of 2¾" (70mm).

To order 220V Model, add "X" to catalog number. (ex. MBQ-200DX)

Add "A" suffix for cabinets with factory installed accessories. (ex. MBQ-200DA)w

Available Sizes

Two-Door Models

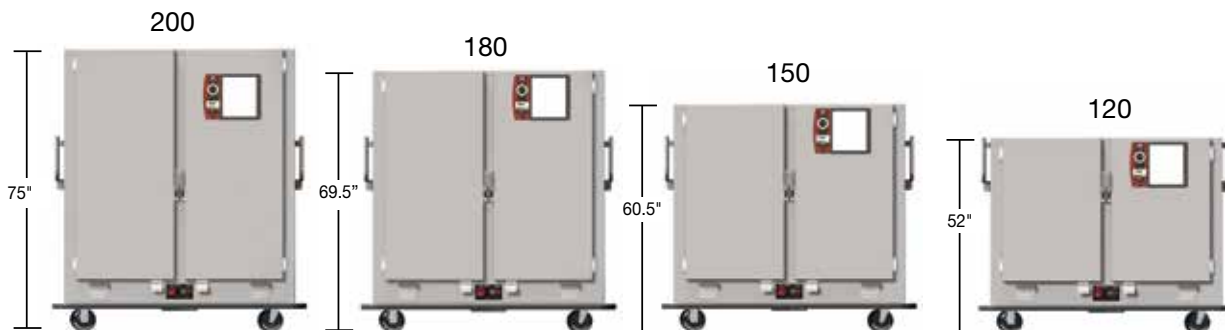

All Double-Door cabinets are 67¼" wide and 33⅜" deep

One-Door Banquet Cabinets — {13.33}

One-door cabinets are economical, come with either standard electric or Quad-Heat™ thermal systems, and are designed to hold up to 11" (279mm) diameter covered plates. Smaller capacity cabinets are available in one-door configurations.



NEMA 5-15P
120V, 60Hz, 1650W



NEMA 6-15P
220V, 50/60Hz, 1650W



Quad-Heat™ unit shown with optional Swing-Up Pull Handle.

One-Door Banquet Cabinets

Thermal System	Stacked	11" Plate Capacity Covered Carrier	Covered Plates Open Carrier	Shelf Stacked High	Size (in.)	Shelves	Shelf Clearance (in.)	Height/Depth/Width (in.)	Shipping Weight (lbs.)	Cat. No.
Standard	180*	180	150	6	55x22	3	17	69.5x30.625x63.625	521	MBQ-180
Quad-Heat	180*	180	150	6	55x22	3	17	69.5x30.625x63.625	556	MBQ-180-QH
Standard	144*	144	120	6	44x22	3	17	69.5x30.625x52.625	421	MBQ-144
Quad-Heat	144*	144	120	6	44x22	3	17	69.5x30.625x52.625	456	MBQ-144-QH
Standard	120*	120	96	5	44x22	3	14	60.5x30.625x52.625	408	MBQ-120
Quad-Heat	120*	120	96	5	44x22	3	14	60.5x30.625x52.625	443	MBQ-120-QH
Standard	90*	90	72	5	33x22	3	14	60.5x30.625x41.625	327	MBQ-90
Quad-Heat	90*	90	72	5	33x22	3	14	60.5x30.625x41.625	362	MBQ-90-QH
Standard	72*	72	60	6	33x22	2	17	52.0x30.625x41.625	302	MBQ-72
Quad-Heat	72*	72	60	6	33x22	2	17	52.0x30.625x41.625	337	MBQ-72-QH

*Capacities based on maximum cover diameter of 11" (279mm), plate and cover height of 2³/₄" (70mm).

To order 220V Model, add "X" to catalog number. (ex. MBQ-180X)

Add "A" suffix for cabinets with factory installed accessories. (ex. MBQ-180A)

Available Sizes

One-Door Models

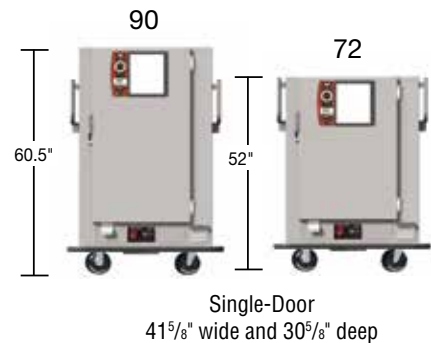
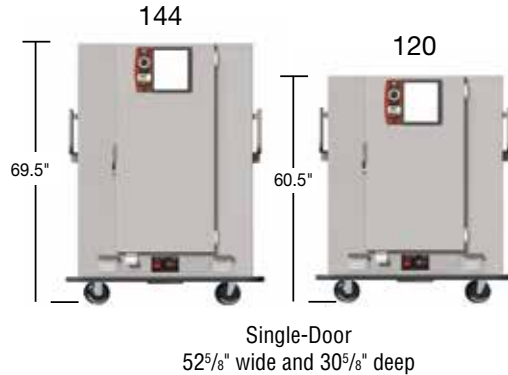



BANQUET CABINET ACCESSORIES — {13.34}



Swing-Up Shelf Accessory

Allows middle shelves to be lifted out of the way providing easy access for loading and unloading lower shelves. Available on both one- and two-door models.

Description	Cat. No.
Swing-Up Shelf Accessory	MBQ-SUSA



Travel Latch

Provides extra security when traveling longer distances in uncontrolled areas. Lockable design works on both one- and two-door models.

Description	Cat. No.
Travel Latch	MBQ-TRVL

Note: Two required for Top-Mount Cabinets



Caster Upgrades

Description	Cat. No.
8" (203mm) Caster Upgrade	MBQ-8
8" (203mm) Semi-Pneumatic Style Caster*	MBQ-8AIR

*Note: Semi-pneumatic style casters are not available on 200 plate capacity cabinet. (MBQ-200D and MBQ-200D-QH)



NEMA 5-20P

20 Amp Plug For CUL*

Description	Cat. No.
NEMA 5-20P plug for CUL	MBQ-P20A

*Note: Required for cabinets destined for Canada.

SWING-UP PULL HANDLE

Provides additional control and visibility when moving the cabinet. Available on both one- and two-door models.

Description	Cat. No.
Swing-Up Pull Handle	MBQ-SUPH

Mini-Rack

Unique system holds 18"x26" (457x660mm) sheet pans. 12"x20"x3" (305x508x76mm) steamtable pans, or a combination of both. Available for 2 door models only.

Description	Cat. No.
Mini-Rack for 200 & 150 Two-Door Models (3 Levels at 3.4" Spacing)	MBQ-MR-14
Mini-Rack for 180 & 120 Two-Door Models (4 Levels at 3.4" Spacing)	MBQ-MR-17

CABINET MINI-RACK CAPACITIES

200 Two-Door holds (8) MBQ-MR-14	150 Two-Door holds (6) MBQ-MR-14
180 Two-Door holds (6) MBQ-MR-17	120 Two-Door holds (4) MBQ-MR-17



Open Plate Carriers

Wire carrier for holding up to ten uncovered plated meals.

Description	Cat. No.
8-Plate Capacity Carrier for One-Door Cabinets	MBQ-P1-14
10-Plate Capacity Carrier for One-Door Cabinets	MBQ-P1-17
8-Plate Capacity Carrier for Two-Door Cabinets	MBQ-P2-14
10-Plate Capacity Carrier for Two-Door Cabinets	MBQ-P2-17

CABINET CARRIER CAPACITIES

200 Two-Door holds (20) MBQ-P2-14	144 One-Door holds (12) MBQ-P1-17
180 Two-Door holds (15) MBQ-P2-17	120 One-Door holds (12) MBQ-P1-14
150 Two-Door holds (15) MBQ-P2-14	90 One-Door holds (9) MBQ-P1-14
120 Two-Door holds (10) MBQ-P2-17	72 One-Door holds (6) MBQ-P1-17
180 One-Door holds (15) MBQ-P1-17	



Covered Plate Carriers

Wire carrier for holding up to twelve covered plated meals.

Description	Cat. No.
10-Plate Capacity Carrier for One-Door Cabinets	MBQ-C1-14
12-Plate Capacity Carrier for One-Door Cabinets	MBQ-C1-17
10-Plate Capacity Carrier for Two-Door Cabinets	MBQ-C2-14
12-Plate Capacity Carrier for Two-Door Cabinets	MBQ-C2-17

CABINET CARRIER CAPACITIES

200 Two-Door holds (20) MBQ-C2-14	144 One-Door holds (12) MBQ-C1-17
180 Two-Door holds (15) MBQ-C2-17	120 One-Door holds (12) MBQ-C1-14
150 Two-Door holds (15) MBQ-C2-14	90 One-Door holds (9) MBQ-C1-14
120 Two-Door holds (10) MBQ-C2-17	72 One-Door holds (6) MBQ-C1-17
180 One-Door holds (15) MBQ-C1-17	



BANQUET CABINET CAPACITIES

2 Door Models	Plate & Cover Height	Cover Dia	Plate Capacity	Cover Dia	Plate Capacity	Cover Dia	Plate Capacity
MBQ-200D	up to 2.75"	up to 11.75"	200	11.875" to 12.75"	160	12.875" to 13.125"	140
	2.875" - 3.375"		160		128		112
	3.5" - 4.625"		120		96		84
	4.75" - 6.875"		80		64		56
	7" & Over		40		32		28
MBQ-180D & MBQT-180D	up to 2.75"	up to 11.75"	180	11.875" to 12.75"	144	12.875" to 13.125"	126
	2.875" - 3.375"		150		120		105
	3.5" - 4.125"		120		96		84
	4.25" - 5.625"		90		72		63
	5.75" - 8.375"		60		48		42
8.5" & Over	30	24	21				
MBQ-150D & MBQT-150D	up to 2.75"	up to 11.75"	150	11.875" to 12.75"	120	12.875" to 13.125"	105
	2.875" - 3.375"		120		96		84
	3.5" - 4.625"		90		72		63
	4.75" - 6.875"		60		48		42
	7" & Over		30		24		21
MBQ-120D	up to 2.75"	up to 11.75"	120	11.875" to 12.75"	96	12.875" to 13.125"	84
	2.875" - 3.375"		100		80		70
	3.5" - 4.125"		80		64		56
	4.25" - 5.625"		60		48		42
	5.75" - 8.375"		40		32		28
8.5" & Over	20	16	14				

(10) Plates per Level (8) Plates per Level (7) Plates per Level

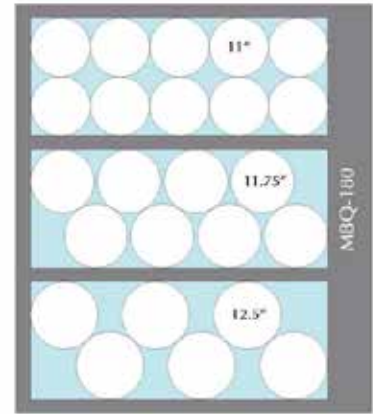
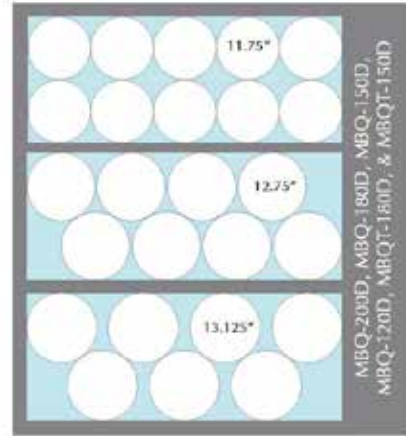

1 Door Models	Plate & Cover Height	Cover Dia	Plate Capacity	Cover Dia	Plate Capacity	Cover Dia	Plate Capacity
MBQ-180	up to 2.75"	up to 11"	180	11.125" to 11.75"	144	11.875" to 12.5"	108
	2.875" - 3.375"		150		120		90
	3.5" - 4.125"		120		96		72
	4.25" - 5.625"		90		72		54
	5.75" - 8.375"		60		48		36
	8.5" & Over		30		24		18

(10) Plates per Level (8) Plates per Level (6) Plates per Level

1 Door Models	Plate & Cover Height	Cover Dia	Plate Capacity	Cover Dia	Plate Capacity	Cover Dia	Plate Capacity
MBQ-144	up to 2.75"	up to 11"	144	11.125" to 11.75"	108	11.875" to 12.25"	90
	2.875" - 3.375"		120		90		75
	3.5" - 4.125"		96		72		60
	4.25" - 5.625"		72		54		45
	5.75" - 8.375"		48		36		30
	8.5" & Over		24		18		15
MBQ-120	up to 2.75"	up to 11"	120	11.125" to 11.75"	90	11.875" to 12.25"	75
	2.875" - 3.375"		96		72		60
	3.5" - 4.625"		72		54		45
	4.75" - 6.875"		48		36		30
	7" & Over		24		18		15

(8) Plates per Level (6) Plates per Level (5) Plates per Level

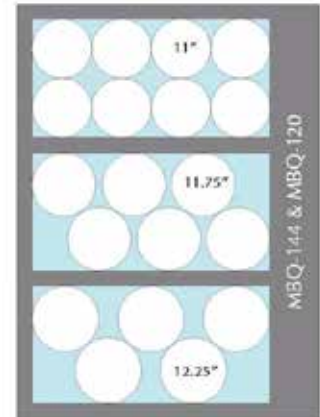

1 Door Models	Plate & Cover Height	Cover Dia	Plate Capacity	Cover Dia	Plate Capacity	Cover Dia	Plate Capacity
MBQ-90	up to 2.75"	up to 11"	90	11.125" to 12"	60	12.125" to 13.125"	45
	2.875" - 3.375"		72		48		36
	3.5" - 4.625"		54		36		27
	4.75" - 6.875"		36		24		18
	7" & Over		18		12		9
MBQ-72	up to 2.75"	up to 11"	72	11.125" to 12"	48	12.125" to 13.125"	36
	2.875" - 3.375"		60		40		30
	3.5" - 4.125"		48		32		24
	4.25" - 5.625"		36		24		18
	5.75" - 8.375"		24		16		12
	8.5" & Over		12		8		6

(6) Plates per Level (4) Plates per Level (3) Plates per Level



Banquet Service Cart — “Queen Mary” — {12.50}

For banquet service, bussing, general back-of-the-house transportation and mobile storage.

- All welded 16-gauge stainless steel construction.
- 8" (203mm) polyurethane casters, two rigid, two swivel.
- Three-Point-Control Handle.
- Wraparound bumper protects cart, walls, and other equipment.
- Optional Swing-Up Pull Handle available.

Description	Length/Width/Height (in.)	Length/Width/Height (mm)	Approx. Pkd. Wt. (lbs.) (kg)		Cat. No.
Five Flat Shelves	64x31x66	1626x787x1651	300	136	MQ-512F
Six Flat Shelves	64x31x66	1626x787x1767	325	147	MQ-609F
Five Ledge Shelves	64x31x65	1626x787x1651	300	136	MQ-512L
Six Ledge Shelves	64x31x66	1626x787x1767	325	147	MQ-609L

For swing-up pull handle, add “-H” to the part number. Example: MQ-609F-H



“Queen Mary”



TC90 Series — Half-Height Heated Insulated Transport Cabinets — {13.28}

- Low center of gravity assures safe transport and use.
- Analog thermometer for consistent and accurate readings, even when unit is not plugged in.
- Stainless interior and removable slide racks provide easy cleaning.
- Convenient kick latch provides “hands-free” easy opening.
- Slide spacing is 2⁵/₈" (67mm) lip loaded for steam table pans and bottom loaded for bun pans.



NEMA 5-15P
950 W



Cat. No.	Style	Dimensions (HxWxD)	Pan Capacity				Approx. Pkd. Wt. (lbs.)
			Sheet Pans 18"x26"	12"x20"x2.5"	Steam Pans 12"x20"x4"	12"x20"x6"	
TC90S	Without Bumper	37"x 21 ¹ / ₄ "x 24 ³ / ₄ "	NA	9	4	3	110
TC90SB	With Bumper	37"x 22 ⁷ / ₁₆ "x 27 ¹ / ₄ "	NA	9	4	3	110
TC90B	Without Bumper	37"x 27 ¹ / ₄ "x 30 ³ / ₄ "	9	NA	NA	NA	128
TC90BB	With Bumper	37"x 28 ⁷ / ₁₆ "x 33 ¹ / ₄ "	9	NA	NA	NA	128



CD3N



CD Series Cabinets — {13.01}

Designed for enclosed transport and storage of 18"x26" (457x660mm) bun pans.

- 14 gauge high-strength natural finish aluminum, riveted construction and cast aluminum corners.
- Lockable door recedes into sidewall so cabinets occupy minimum space.
- 1 1/2" (38mm) slide spacing.

Width/Height/Depth (in.) (mm)		Inside Height (in.) (mm)		Pan Capacity No.	Approx. Pkd. Wt. (lbs.) (kg)		Cat. No.	
21 1/2	63 1/4 x 28	533	1607 x 711	52 5/8	1336	35	85 38	CD3N
21 1/2	71 1/2 x 28	533	1816 x 711	60 5/8	1539	40	95 42	CD4N

Note: Brakes are standard on two casters, for the units listed above.

Accessories

Description	Model
Gray Corner Bumpers	A32
*Gray Continuous Bumper	A33
Floor Lock	A71

*Adds 2" (51mm) to overall width and depth of rack.

End-Load and Side-Load Wire Bun Pan Racks — {13.42}

Economical solution for storage and transport of bun pans.

- End-load models provide a large tray landing area, side-load models are highly space efficient.
- Choice of 1 1/2" (38mm) spacing (38 pans) or 3" (76mm) (20 pans) spacing.
- Quick, easy no-tool assembly, rolls easily on 5" (127mm) swivel casters.
- Durable Super Erecta Brite™ finish.
- All units are 69" (1752mm) high.

Width/Length (in.) (mm)		Slide Spacing (in.) (mm)		Pan Capacity Size			Approx. Pkd. Wt.		Description	Cat. No.		
(in.)	(mm)	(in.)	(mm)	No.	(in.)	(mm)	(lbs.)	(kg)				
21 3/4	x27	552	x685	1 1/2	38	38	18x26	457x660	61	27.7	End-Load	RE1
21 3/4	x27	552	x685	3	76	20	18x26	457x660	70	31.8	End-Load	RE3
19 1/2	x30	495	x762	1 1/2	38	38	18x26	457x660	61	27.6	Side-Load	RS1
19 1/2	x30	495	x762	3	76	20	18x26	457x660	70	31.8	Side-Load	RS3

Weight Load Capacity: 30 lbs. (13.6kg) per level; 200 lbs. (91kg) per rack.

Accessories

Description	Model
3 1/2" (90mm) Diameter Rubber Donut Bumper	9992DB
5 1/2" (140mm) Diameter Rubber Donut Bumper	9992N



Wire Bun Pan Racks

Portable Wire Prep Rack — {13.44}

Made to accommodate standard 18"x26" (457x660mm) trays or pans.

- The 1/2" (12.7mm) food grade polyethylene cutting board/work surface provides an area for slicing, mixing, garnishing or other types of food preparation.
- Rolls easily on 5" (127mm) swivel casters.
- Units assemble quickly and easily without special tools.

Width/Length (in.) (mm)		Height (in.) (mm)		Slide Spacing (in.) (mm)		Pan Capacity Size			Approx. Pkd. Wt.		Description	Cat. No.		
(in.)	(mm)	(in.)	(mm)	(in.)	(mm)	No.	(in.)	(mm)	(lbs.)	(kg)				
21 3/4	x27	550	x685	36	914	1 1/2	38	16	18x26	457x660	50	22.6	End-Load	RE1P
21 3/4	x27	550	x685	36	914	3	76	8	18x26	457x660	60	27.2	End-Load	RE3P

Accessories

Description	Model
3 1/2" (90mm) Diameter Rubber Donut Bumper	9992DB
5 1/2" (140mm) Diameter Rubber Donut Bumper	9992N



Portable Wire Prep Rack

End-Load Racks — Single Section — {13.50}

- Units feature sturdy, riveted 6063-T6 aluminum construction. Pass-thru design affords maximum convenience.
- Space saving, ideal for freezers, coolers, bakeries.



RD3N



Width/Height/Depth (in.)	(mm)	Slide Spacing (in.)	(mm)	Pan Capacity Size		Approx. Pkd. Wt.		Cat. No.
				No.	(in.) (mm)	(lbs.)	(kg)	
21 ¹ / ₂ x69 ³ / ₄ x29	546x1772x736	3	76	20	18x26 457x660 Pans	52	23.6	RD3N
				or 40	14x18 355x457			
21 ¹ / ₄ x69 ³ / ₄ x26 ¹ / ₂	546x1772x673	1 ¹ / ₂	38	40	18x26 457x660 Pans	52	23.6	RD13N
20x63 ³ / ₄ x23	508x1619x584	3	76	18	15x20 381x508 Trays	49	22.2	RD15N
				or 18	16x22 406x553			
21 ¹ / ₂ x69 ³ / ₄ x29	546x1772x736	5	127	12	18x26 457x660 Pans	45	20.4	RD23N
				or 24	14x18 355x457			

Note: 5" (127mm) swivel casters, two with brakes, are standard on units listed above.
Weight Load Capacity: 20 lbs. (9kg) per slide; 350 lbs. (159kg) per rack.

Accessories

Description	Model
*Gray Continuous Bumper	A33RD
**Gray Corner Bumpers	A37
Pan Stop	A120

*Adds 2" (51mm) to overall width and depth of rack.
**Adds 1/2" (12.7mm) to overall width and 1" (25mm) to overall depth of rack.

Notes: Accessories must be ordered with rack. Not designed for field installation. Accessorized racks shipped assembled. Part numbers will be combined to signify complete unit at time of order entry.



RD33N



Side-Load Rack — Single Section — {13.52}

Width/Height/Depth (in.)	(mm)	Inside Height (in.)	(mm)	Slide Spacing (in.)	(mm)	Pan Capacity Size		Approx. Pkd. Wt.		Cat. No.
						No.	(in.) (mm)	(lbs.)	(kg)	
29 ³ / ₈ x69 ¹ / ₄ x18 ³ / ₈	746x1758x472	60 ¹ / ₂	1536	3	76	20	18x26 457x660	45	20.2	RD33N

Note: 5" (127mm) swivel casters, two with brakes, are standard on units listed above.
Weight Load Capacity: 20 lbs. (9kg) per slide level; 350 lbs. (159kg) per rack. Allowable temperature range: -30°F (-34°C) to 160°F (71°C).

Adjustable Rack — {13.56}

Ideal for holding a variety of items of different sizes at different times.

- 13 Sets of "Vari-Slides" accommodate all popular modules used in the foodservice industry.
- Made of special extrusion (.100" or 2.5mm thick) with bending support design for heavy loads.
- Keyholes in uprights on 1¹/₂" (38mm) spacing. Inside height is 60¹/₄" (1530mm).



RD78N



Width/Height/Depth (in.)	(mm)	Pan Capacity with (13) Standard Sets of Slides on 4 ¹ / ₂ " (114mm) Centers*						Approx. Pkd. Wt.		Cat. No.
		2 per Slide Size			1 per Slide Size			(lbs.)	(kg)	
No.	(in.)	(mm)	No.	(in.)	(mm)	(lbs.)	(kg)			
24 ³ / ₈ x69 ¹ / ₂ x26	619x1765x660	26	10 ⁷ / ₈ x19 ³ / ₄	274x501	13	15x20 380x520	93	41.8	RD78N	
		26	11 ¹ / ₈ x20	284x508	13	18x26 457x660				
		26	12x18	304x457	13	20x20 508x508				
		26	12x20	304x508	13	20x22 508x558				
		26	13x18	330x457	13	20x24 508x609				
		26	14x18	335x457						

*Vertical supports punched on 1¹/₂" (38mm) centers for adjustability.

Note: 5" (127mm) heavy-duty swivel casters with neoprene wheels, two with brakes, are standard on unit listed above.

Notes: Accessories must be ordered with rack. Not designed for field installation.

Accessorized racks shipped assembled. Part numbers will be combined to signify complete unit at time of order entry.

Weight Load Capacity: 50 lbs. (22.7kg) per slide level; 350 lbs. (159kg) per rack. Allowable temperature range: -30°F (-34°C) to 160°F (71°C).

Accessories

Description	Model
*Gray Continuous Bumper	A33RD
**Gray Corner Bumpers	A37
Extra Slides (Will take 4 extra pair max.)	A121
Floor Lock	A71

*Adds 2" (51mm) to overall width and depth of rack.

**Adds 1/2" (12.7mm) to overall width and 1" (25mm) to overall depth of rack.

End-Load “Knock Down” Racks — Single Section — {13.70}

Width/Height/Depth (in.) (mm)		Inside Height (in.) (mm)		Slide Spacing (in.) (mm)		No.	Pan Capacity Size (in.) (mm)		Approx. Pkd. Wt. (lbs.) (kg)		Cat. No.
20 ³ / ₈ x64 ¹ / ₈ x28	518x1630x711	55 ⁷ / ₈	1417	3	76		18	18x26	457x660	53	
						or 36	14x18	355x457			
20 ³ / ₈ x64 ¹ / ₈ x28	518x1630x711	55 ⁷ / ₈	1417	5	127	11	18x26	457x660	50	22.5	RT115N
						or 22	14x18	355x457			
20 ³ / ₈ x64 ¹ / ₈ x28	518x1630x711	55 ⁷ / ₈	1417	1 ¹ / ₂	28	34	18x26	457x660	55	24.7	RT1334N

Note: 5" (127mm) swivel casters, two with brakes, are standard on units listed above.
 Weight Load Capacity: 20 lbs. (9kg) per slide level; 300 lbs. (136kg) per unit. Allowable temperature range: -30°F (-34°C) to 160°F (71°C).

Accessories

Description	Model
Vertical Corner Bumpers	A38

Notes: Accessories must be ordered with rack.
 Not designed for field installation.
 Accessorized racks shipped assembled.
 Part numbers will be combined to signify complete unit at time of order entry.



Side-Load “Knock Down” Racks — {13.72}

Width/Height/Depth (in.) (mm)		Inside Height (in.) (mm)		Slide Spacing (in.) (mm)		No.	Pan Capacity Size (in.) (mm)		Approx. Pkd. Wt. (lbs.) (kg)		Cat. No.
28 ³ / ₈ x64 ¹ / ₈ x18 ³ / ₄	721x1628x476	56 ¹ / ₂	1435	3	76		18	18x26	457x660	40	
28 ³ / ₈ x64 ¹ / ₈ x18 ³ / ₄	721x1628x476	56 ¹ / ₂	1435	5	127	11	18x26	457x660	38	17.1	RT3511N

Note: 5" (127mm) swivel casters, two with brakes, are standard on units listed above.
 Weight Load Capacity: 20 lbs. (9kg) per slide level; 300 lbs. (136kg) per rack. Allowable temperature range: -30°F (-34°C) to 160°F (71°C).





RF13N

Roll-In Refrigerator Racks — {13.80}

Rack rolls directly into refrigerator for quick and easy storage.

- Natural finish, high-strength, extruded aluminum (6063-T6 alloy), riveted construction.
- Pass-Thru Design can be loaded on one side and unloaded from the other for maximum efficiency and convenience.

Width/Height/Depth (in.)	Width/Height/Depth (mm)	Slide Spacing (in.)	Slide Spacing (mm)	Pan Capacity		Approx. Pkd. Wt. (lbs.) (kg)	Cat. No.
				No.	Size (mm)		
21 ¹ / ₂ x64 ³ / ₄ x26	539x1645x660	1 ¹ / ₂	38	36	18x26 457x660	44 19.8	RF13N
21 ³ / ₈ x64 ³ / ₄ x26	543x1645x660	3	76	18	18x26 457x660	55 24.7	RF3N
21 ³ / ₈ x64 ³ / ₄ x26	543x1645x660	5	127	11	18x26 457x660	43 19.3	RF23N

Width/Height/Depth (in.)	Width/Height/Depth (mm)	Pan Capacity with (12) Standard Sets of Slides on 4 ¹ / ₂ " (114mm) Centers*				Approx. Pkd. Wt. (lbs.) (kg)	Cat. No.		
		2 per Slide		1 per Slide					
		No.	Size (in.)	Size (mm)	No.	Size (in.)	Size (mm)		
24 ³ / ₈ x64 ¹ / ₂ x26	619x1688x660	24	10 ⁷ / ₈ x19 ³ / ₄	274x501	12	15x20	380x520	92 41.4	RF78N
		24	11 ¹ / ₈ x20	284x508	12	18x26	457x660		
		24	12x18	304x457	12	20x20	508x508		
		24	12x20	304x508	12	20x22	508x558		
		24	13x18	330x457	12	20x24	508x609		
		24	14x18	335x457					

*Vertical supports punched on 1¹/₂" (38mm) centers for adjustability.
Note: 5" (127mm) swivel casters, two with brakes, are standard on units listed above.
 Weight Load Capacity: 20 lbs. (9kg) per slide level; 350 lbs. (159kg) per rack.
 Allowable temperature range: -30°F (-34°C) to 160°F (71°C).



RF78N

Accessories

Description	Model
*Gray Continuous Bumper	A33RD
**Gray Corner Bumpers	A37
Extra Slides for RF78N	A121
Floor Lock (for use with RF78N Only)	A71

*Adds 2" (51mm) to overall width and depth of rack.
 **Adds 1/2" (12.7mm) to overall width and 1" (25mm) to overall depth of rack.
Notes: Accessories must be ordered with rack. Not designed for field installation.
 Accessorized racks shipped assembled. Part numbers will be combined to signify complete unit at time of order entry.

Oval Tray Rack — {13.58}

Special design, natural finish, high-strength, extruded aluminum (6063-T6 alloy) framework with 8-gauge brake-formed slides. Pass-thru design is lightweight, maneuvers easily. Ideal for banquet service.

Width/Height/Depth (in.)	Width/Height/Depth (mm)	Slide Spacing (in.)	Slide Spacing (mm)	Pan Capacity		Approx. Pkd. Wt. (lbs.) (kg)	Cat. No.
				No.	Size (mm)		
27x70 ¹ / ₄ x29	685x1784x736	6	152	10	22 ³ / ₄ x27 ⁵ / ₈ 577x701	88 39.6	RD27N

Note: 5" (127mm) heavy-duty swivel casters with neoprene wheels, two with brakes, are standard on unit listed above.
 Weight Load Capacity: 50 lbs. (22.7kg) per slide level; 350 lbs. (159kg) per rack.
 Allowable temperature range: -30°F (-34°C) to 160°F (71°C).

Accessories

Description	Model
*Gray Continuous Bumper	A33RD
**Gray Corner Bumpers	A37
Pan Stop	A120
Floor Lock	A71

*Adds 2" (51mm) to overall width and depth of rack.
 **Adds 1/2" (12.7mm) to overall width and 1" (25mm) to overall depth of rack.
Notes: Accessories must be ordered with rack. Not designed for field installation. Accessorized racks shipped assembled. Part numbers will be combined to signify complete unit at time of order entry.



RD27N



T-Series:
Durable &
efficient, food
transport.
pg. 178



**Built to
handle
anything
you can
dish out.**

WARE HANDLING

“Poker Chip” Dish Dollies.....	204-205
Side-Load Dish and Tray Carts.....	206
Ice Carts & Ware Handling Racks	207

Hello Dolly.

DELIVERING ADJUSTABILITY, VARIETY & PROTECTION



Adjustable towers offer maximum versatility.

Recessed handles for better maneuverability and efficient storage.

One-piece, sturdy polymer construction is extremely durable and easy to clean.

Standard 5" (127mm) neoprene swivel casters (two with brakes) for easy maneuverability.

PCD11A

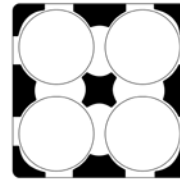
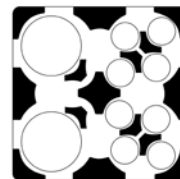

Plate sizes 9 5/8" – 11 3/4"
4 Columns (60 per)
*Capacity 240



4 1/4" – 4 5/8"
8 Columns (40 per)
7 1/2" – 9 1/2"
2 Columns (60 per)

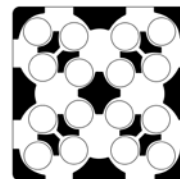

Plate sizes 4 1/4" – 4 5/8"
16 Columns (40 per)
*Capacity 640

*Varies on china shape & thickness.

Usable column height is 20"



PCD9



PCD9 shown with glass rack (Glass rack not included.)

EFFICIENCY, STYLE AGILITY AT YOUR FINGERTIPS

- Built-in Microban® Antimicrobial Product Protection.
- "Fixed Position" PCD's are designed to hold 5", 7", 8", 9", 11" or 12" plates securely in place.
- Versatile design allows transport of glass racks.

SIDE-LOAD DISH & TRAY CARTS

- Perfect for holding a variety of different sized dishes, odd-shaped platters and trays.
- New recessed handles increase maneuverability and make transport effortless.
- One-piece, sturdy polymer construction with built-in drain holes promote cleanability.



Model DSD11 shown with optional divider accessory A110



Model SSD16 shown with optional divider accessory A110



Adjustable Polymer “Poker Chip” Dish Dollies — {16.21}

(with *Microban® Antimicrobial Product Protection)

Unique design utilizing adjustable, removable towers provides total flexibility and maximum loading density. Two-handed access to all dish columns means easy retrieval and reduced chance of dish breakage. Handle dish sizes from 4¹/₄" (108mm) to 11³/₄" (298mm) in diameter.

- High-density polymer shell is resistant to cracking, peeling, and chipping. Smooth surfaces prevent snags.
- Square compact design allows for maximum space utilization and stores conveniently under counters, out of the way.
- Standard 5" (127mm) neoprene swivel casters (two with brakes) for easy maneuverability.
- Vinyl dust cover included.
- NSF listed.



PCD11A

Metro Tip:

Adjustable Poker Chip Dish Dollies are perfect for carrying multiple-size dishes, or if you're not sure of the sizes you will be using.

Width/Height/Depth (in.) (mm)		Approx. Pkd. Wt. (lbs.) (kg)		Cat. No.
26 ⁵ / ₈ x31 ¹⁵ / ₁₆ x26 ⁵ / ₈	676x812x676	65	30	PCD11A

Protective cover is standard.

Accessories

Description	Model
4 Additional Dividers	AD11A
Additional Cover	PCDV11A

Polymer “Poker Chip” Dish Dollies — {16.23}

(with *Microban® Antimicrobial Product Protection)

Two-handed dish access for easy retrieval and less chance of breakage.

- Chip-resistant polymer shell has snag-proof surface.
- Space efficient square design stores out of the way under counters.
- Standard 5" (127mm) neoprene swivel casters (two with brakes) provides easy maneuverability.
- Vinyl dust cover included.
- NSF listed.

Metro Fact:

Poker Chip Dish Dollies are enhanced with built-in Microban® antimicrobial product protection, which protects the product from bacteria, mold, mildew and fungi that cause odors, stains and product degradation.

Width/Height/Depth (in.) (mm)		No. of Dish Columns	Approx. Dish Capacity Per Column*	Total Approx. Dish Capacity*	Maximum Dish Size (in.) (mm)	Approx. Pkd. Wt. (lbs.) (kg)	Cat. No. Blue**
24 ¹ / ₁₆ x31 ¹⁵ / ₁₆ x24 ¹ / ₁₆	612x812x612	9	40	360-540	5 ⁵ / ₈ 143	61 27	PCD5
27 ¹³ / ₁₆ x31 ¹⁵ / ₁₆ x27 ¹³ / ₁₆	707x812x707	9	40-60	360-540	6 ⁷ / ₈ 175	72 32	PCD7
21 ¹ / ₂ x31 ¹⁵ / ₁₆ x21 ¹ / ₂	547x812x547	4	60	240	8 ¹ / ₄ 210	51 22	PCD8
23 ¹⁵ / ₁₆ x31 ¹⁵ / ₁₆ x23 ¹⁵ / ₁₆	609x812x609	4	60	240	9 ¹ / ₂ 241	56 25	PCD9
26 ¹⁵ / ₁₆ x31 ¹⁵ / ₁₆ x26 ¹⁵ / ₁₆	685x812x685	4	60	240	11 279	65 29	PCD11
30 ¹ / ₈ x31 ¹⁵ / ₁₆ x30 ¹ / ₈	766x812x766	4	60	240	12 ⁵ / ₈ 321	70 32	PCD12

*Loading capacity dependent upon china shapes and thickness.
Protective cover is standard. For additional covers, see accessories below.

Accessories

Description	Model
Additional Cover for PCD5	PCDV5
Additional Cover for PCD7	PCDV7
Additional Cover for PCD8	PCDV8
Additional Cover for PCD9	PCDV9
Additional Cover for PCD11	PCDV11
Additional Cover for PCD12	PCDV12

Metro Tip:

Two-handed access to all dish columns provides for safer loading and unloading. Dollies have four swivel casters for maneuvering in and out of tight quarters.



PCD9

Indicates antimicrobial product.



SSD16 shown with optional Divider Accessory A110



DSD11 shown with optional Divider Accessory A110



D2020N



CBH2121C Dish Rack Dolly (Racks not included)

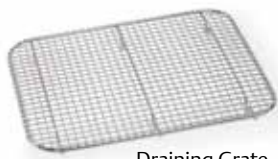

Draining Grate

Side-Load Polymer Dish and Tray Carts — {16.32}

(with *Microban® Antimicrobial Product Protection)

Adjustable dividers accommodate a variety of different-sized dishes and trays.

- Side-load dish and tray carts come in single and double-sided models.
- Perfect for holding a variety of different sized dishes, odd-shaped platters and trays.
- Corrosion-free polymer construction makes surfaces smooth and easy to clean.
- Vinyl dust/splash cover included to protect stored contents.
- Standard 5" (127mm) neoprene swivel casters (two with brakes) for easy maneuverability.

Overall Width/Height/Depth (in.)	Overall Width/Height/Depth (mm)	Approx. Dish Capacity Per Column**	Approx. Tray Capacity Per Column**	Approx. Pkd. Wt. (lbs.) (kg)		Cat. No.
39 ⁵ / ₈ x32 ¹⁵ / ₁₆ x21 ⁵ / ₈	1007x837x550	60	80	82	36	SSD16
39 ⁵ / ₈ x31 ¹⁵ / ₁₆ x29 ¹ / ₁₆	1007x812x739	60	80	100	45	DSD11

**Loading capacity dependent upon chain and tray shapes/thickness. Protective cover is standard. For additional covers, see accessories below.

Accessories

Description	Model
Divider Assembly (1 rod and 2 dividers)	A110
Additional Divider	A115
Additional Cover for Single Side-Load Dish and Tray Cart	SSDV16
Additional Cover for Double Side-Load Dish and Tray Cart	DSDV11

Dish Rack Dollies — {16.14}

Lightweight aluminum, but built for heavy service.

- 5" (127mm) non-marking swivel casters.
- Non-marking corner bumpers.
- Tubular steel handle optional on D2020N.

Overall Width (in.)	Overall Width (mm)	Height (in.)	Height (mm)	Type	Approx. Pkd. Wt. (lbs.) (kg)		Cat. No.
21 ¹ / ₂ sq.	546	6 ¹ / ₈	154	Without Handle	13 ³ / ₈	345	D2020N
21 ¹ / ₂ sq.	546	33 ³ / ₈	843	With Handle	15 ³ / ₄	400	DH2020N
Handle							H2020C

Dollies under 21¹/₂" sq. (546mm) made to order.



D2121C

Cup/Glass Rack Dollies — {16.14}

Store cup/glass racks at a convenient, easy-access height.

Overall Dimensions Width/Length (in.)	Overall Dimensions Width/Length (mm)	Overall Height (in.)	Overall Height (mm)	Type	Appr. Pkd. Wt. (lbs.) (kg)		Cat. No.
20 ⁷ / ₈ x20 ⁷ / ₈	530x530	12 ¹ / ₈	307	Without Bumpers and Handle	28	12.6	D2121C
20 ⁷ / ₈ x23 ⁷ / ₈	530x607	36 ⁵ / ₈	929	With Handle	33	14.8	DH2121C
23 ³ / ₈ x23 ³ / ₈	594x594	12 ¹ / ₈	307	With Corner Bumpers	29	13	CB2121C
23 ³ / ₈ x25	594x635	36 ⁵ / ₈	929	With Corner Bumpers and Handle	34	15.3	CBH2121C

Draining Grate

Outside Dimensions Width/Length (in.)	Outside Dimensions Width/Length (mm)	12 Pieces Per Package Approx. Pkd. Wt. (lbs.) (kg)		Cat. No.
8 ¹ / ₄ x10 ¹ / ₂	209x266	11	4.9	6511DR
10 ¹ / ₈ x18	256x457	22	9.9	6517DR*
16 ¹ / ₂ x24 ¹ / ₂	419x622	28	12.6	6518DR†

*Fits 12"x20" (305x508mm) pan (#200).
†Fits 18"x26" (457x660mm) baking sheet.

Indicates antimicrobial product.

Put your transport woes on ice.

Ice Cart — {13.37}

Features unique patented multi-position lid which opens to 19 1/2"x12" (495x305mm). Double wall and deep insulation will hold ice for extended periods. Rust and corrosion-proof polymer construction. Large rear wheels and front swivel casters for easy mobility.



Ice Cart

Width/Depth/Height (in.) (mm)		Capacity (lbs.) (kg)		Casters		Cat. No.
22 1/2	28 1/4	33 1/2	125	57	8" (203mm) rear; 5" (127mm) front (1 locking)	IC125

Pot and Pan Rack

Description	Width (in.) (mm)		Length (in.) (mm)		Height (in.) (mm)		Casters (amt.) (type)	Approx. Pkd. Wt. (lbs.) (kg)		Cat. No.	
Solid Embossed	24	610	48	1219	68	1727	2	5MP	125	56	PR48ES
							2	5MPB			
Solid Embossed	24	610	60	1524	68	1727	2	5MP	153	66	PR60ES
							2	5MPB			



Pot and Pan Rack

Dry it.



Eliminate
“Wet Nesting” and
kick bacteria to
the curb.

See Pg. 28
for complete drying solutions.



**Clean house
with Metro.**

Lodgix™
MetroTrux™

HOUSEKEEPING, MERCHANDISING, BEER AND WINE STORAGE

Lodgix Housekeeping Carts	210-211
Lodgix Houserunner Carts & Folding Station.....	212
Valet and Amenity Carts & Stations	213-215
Mini Bar Restocking Cart	216
Linen Trucks & Carts	217
Totes & Bins.....	218
Merchandising	219
Beer and Wine Storage & Accessories	220-221

Metro Lodgix™ Housekeeping Carts — {31.01}

Designed to adapt as housekeeping requirements change. Aesthetic appearance presents an upscale image for any facility. Polymer construction means low maintenance and long life.

- Flexible, Modular Design: Designed to be upgradable in the field. Additional storage, locking doors and locking top shroud can be easily added in the field using simple hand tools.
- Polymer Construction: Will not rust, corrode, dent, flake, chip, or peel and is friendly to walls, doors and furnishings for lower maintenance costs.
- 8" (203mm) Wheels Standard: Non-marking wheels are easy to maneuver over any floor surface.
- "Natural Grip" Handle Design: Positions hands properly for ease of use and less fatigue.

- Unique, "Hookless" Bag Mounting Method: Provides a convenient method for securing polyliners.
- Bottom Shelf and Top Handle: Combine to hold brooms, vacuum cleaner, or waste receptacle (with optional waste container bracket).
- Integrated Paper Management System: Convenient storage for menus, directories, etc.
- **Options and Accessories:***
 - Under Deck Vacuum Bracket
 - Under Deck Glass Rack Holder
 - Roller, Corner Bumpers
 - Side Storage Kit
 - Locking Door for Side Storage
 - Locking Top Shroud
 - Center Compartment Shelf
 - End Compartment Shelf
 - Waste Can Bracket

*All options and accessories can be added in the field.



Metro® Transfer/Exchange Cart

Stock Housekeeping Cart from Supply Closet or Exchange Carts



Lodgix Housekeeping Cart

Storage



Metro® Amenity Pick Station

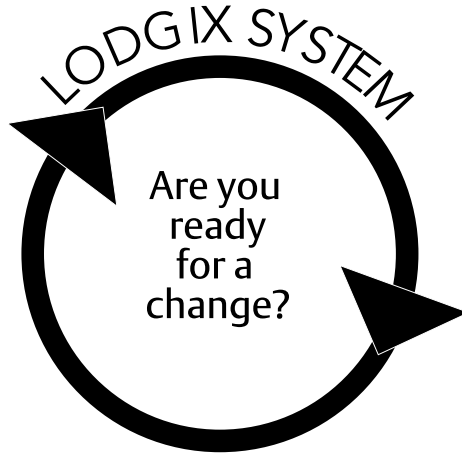

Collect, Sort and Transport Soiled Linen



Metro Lodgix Houserunner Cart

Transport to Floor Closet



Metro® Transfer/Exchange Cart

Wash, Dry, Press, Fold and Stack



MetroTrux® Convertible Linen Truck

Metro Lodgix™ Housekeeping Carts — {31.01}

Description	Exterior Dimensions				Shelf Capacity		Approx. Pkd. Wt.		Cat. No.	
	Length (in.)	Width (mm)	Width (in.)	Height (mm)	cu. ft.	cu. m.	(lbs.)	(kg)		
Metro Lodgix Essentials Standard Height	60	1524	22	559	42	1067	9.8	0.27	82 37.2	LXHK3-ESS
Metro Lodgix Plus Standard Height	60	1524	22	559	42	1067	13.4	0.37	112 50.8	LXHK3-PLUS
Metro Lodgix Pro Standard Height	60	1524	22	559	55	1397	13.4	0.37	132 59.9	LXHK3-PRO
Metro Lodgix Essentials Tall Height	60	1524	22	559	51	1295	13.1	0.37	96 43.5	LXHK4-ESS
Metro Lodgix Plus Tall Height	60	1524	22	559	51	1295	17.9	0.51	134 60.8	LXHK4-PLUS
Metro Lodgix Pro Tall Height	60	1524	22	559	64	1626	17.9	0.51	157 71.2	LXHK4-PRO

*Tall carts come standard with two center shelves.
Top Shroud adds 13" (330mm) to total height of cart.

Description	Interior Dimensions				Shelf Capacity	
	Length (in.)	Width (mm)	Width (in.)	Height (mm)	cu. ft.	cu. m.
Center Storage Area: Standard Height	30	762	21	533	9.8	0.278
Center Storage Area: Tall Height	30	762	21	533	13.1	0.371
Optional Side Storage: Standard Height	11	279	21	533	3.6	0.102
Optional Side Storage: Tall Height	11	279	21	533	4.8	0.136
Under Deck Glass Rack Holder/Shelf	20	508	20	508	1.6	0.046

Options and Accessories

Description	Approx. Pkd. Wt.		Cat. No.
	(lbs.)	(kg)	
Roller, Corner Bumpers	1.25	0.56	LXHK-4CB
Under Deck Vacuum Holder	1	0.45	LXHK-VH
Under Deck Glass Rack Holder/Shelf	10.5	4.8	LXHK-UGRH
Center Compartment Adjustable Shelf	6.25	2.8	LXHK-AS
Locking Top Shroud	17	7.7	LXHK-TS
Side Storage Kit – Standard height carts	15.5	7.0	LXHK3-SSK
Side Storage Kit – Tall Carts	18.5	8.4	LXHK4-SSK
Side Storage Shelf	4.5	2.0	LXHK-SS
Locking Door Kit for Side Storage – Standard Height Carts	3.5	1.6	LXHK3-SDK
Locking Door for Side Storage – Tall Carts	4.5	2.0	LXHK4-SDK
Waste Can	6	2.7	LXHK-WCAN
Waste Can Holder – Standard Height Carts	1	0.45	LXHK3-WCH
Waste Can Holder – Tall Carts	2	0.91	LXHK4-WCH
Vinyl-Coated Nylon Laundry Bag – Standard Height Carts	2	0.91	LXHK3-NB
Vinyl-Coated Nylon Laundry Bag – Tall Carts	2.5	1.13	LXHK4-NB
3" (76mm) Large Capacity Tote (6 per carton)*	9	4.1	TB92035NAT-LX
6" (152mm) Large Capacity Tote (4 per carton)*	9.32	4.3	TB92060NAT-LX

*Items must be purchased in carton quantities to avoid a broken lot charge.



Metro Lodgix Essentials



Metro Lodgix Plus



Metro Lodgix Pro



Lockable Side Storage Door



Lockable Top Shroud



Under-Deck Glass Rack Holder



Waste Can Bracket

 Under-Deck Vacuum Bracket
(Shown with optional bumpers)

Large Capacity Totes

Helpful Hint:

Make it easier for your cart to go over thresholds and take outdoors by adding neverflat casters. Must be factory ordered.

Just add "P" to the Catalog No. Contact Metro for details.

Metro Lodgix Houserunner Carts — {31.10}

Versatile product designed to support the housekeeping function. Useful for the collection of bulk soiled linens as well as the restocking of housekeeping carts.

- Three models to fit a variety of needs.
- Easy to Clean design promotes sanitary operation.
- Bottom Shelf Supports laundry bag and helps contain spills. Bottom shelf on Plus and Pro models conveniently holds glass racks.
- Extra Shelves on Pro model expand the use of the Houserunner cart to that of a resupply cart.
- Corner Bumpers standard on all Houserunner Carts.



Metro Lodgix Houserunner Essentials
Basic collection cart featuring 7-bushel nylon laundry bag, solid bottom shelf and 5" (127mm) casters (two swivel, two rigid).

Metro Lodgix Houserunner Plus
All the features of the Essentials Cart plus the addition of a second open wire shelf for added capacity. Shelf can hold a standard glass rack.

Metro Lodgix Houserunner Pro
Pro model adds more capacity with a larger bottom shelf (24"x36" [610x914mm]) and the addition of two 12"x24" (305x610mm) adjustable shelves.

Description	Exterior Dimensions			Capacity Bu.	Approx. Pkd. Wt.		Cat. No.
	Length (in.) (mm)	Width (in.) (mm)	Height (in.) (mm)		(lbs.)	(kg)	
Metro Lodgix Houserunner Essentials	24	610	33	7	39	17.7	LXHR-ESS
Metro Lodgix Houserunner Plus	24	610	39	7	52	23.6	LXHR-PLUS
Metro Lodgix Houserunner Pro	36	914	39	7	64	29.0	LXHR-PRO

Options and Accessories

Description	Approx. Pkd. Wt.		Model No.
	(lbs.)	(kg)	
Vinyl-coated Nylon Laundry Bag	2	0.91	LXHR-NB

Folding/Laundry Stations

Can be assembled by ordering the individual components shown below.

As shown:



Folding/Laundry Station

Description	Qty.	Cat. No.
Posts for Stem Casters	4	33UP
Stem Casters — Rigid	2	5MDRA
Stem Casters — Brake	2	5MDBA
Super Erecta® Stainless Solid Shelf	1	2448FS
Super Adjustable Super Erecta® Wire Shelf	1	A2448NC

Hospitality you can get used to.

Valet/Laundry or Special Delivery Cart — {31.54}

Specially designed cart works both as a Laundry/Valet Cart for special garment cleaning requests or as a Valet Delivery Cart for special deliveries.

- Organized storage and transport cart provides both shelf and hanging storage. Lightweight cart is quick to the task leaving luggage carts for heavy-duty deliveries.
- Maneuverable: Five-inch (127mm) swivel casters, two with brakes, make the cart glide easily over all floor surfaces.
- Cart construction and finish: Super Erecta® construction with Brite™ chrome finish on post and shelves.



Standard Model #HVDC2448 on stem casters with 24" (610mm) intermediate shelves.

Style	Width		Length		Coat Hanger Tube Length		Shelf Length		No. of Dividers	Cat. No.
	(in.)	(mm)	(in.)	(mm)	(in.)	(mm)	(in.)	(mm)		
Standard	24	610	48	1219	24	610	24	610	8	HVDC2448

Covers* for Valet/Laundry Special Delivery Cart

- Help protect contents from dust and other air-borne contaminants.
- This allows units to be loaded and stored for longer periods of time before being transported. Covers also deter pilferage.
- Reinforced Corners: Help prevent tears and add greatly to durability of covers.
- Closure: Available in hook/loop or heavy-duty nylon zipper

Uncoated — machine washable:

- White: Knitted polyester, 4 oz. per square yard
- Mariner Blue: Woven polyester, 3.2 oz. per square yard.

Coated — waterproof, perfect for indoor/outdoor use:

- White or Mariner Blue — vinyl-coated nylon, 10 oz. per square yard
- Specially treated to resist bacteria, odor, mildew and flames



Cover on Valet Cart

Finish	Color*	Approx. Pkd. Wt.		Cat. No.	
		(lbs.)	(kg)	Zippered Closure	Velcro Closure
Uncoated	White	4	1.8	24X48X62UC	24X48X62VUC
Coated	White	4	1.8	24X48X62C	24X48X62VC
Uncoated	Mariner Blue	4	1.8	24X48X62UCMB	24X48X62VUCMB
Coated	Mariner Blue	6	2.7	24X48X62CMB	24X48X62VCMB

*Other colors available. Custom pricing applies.

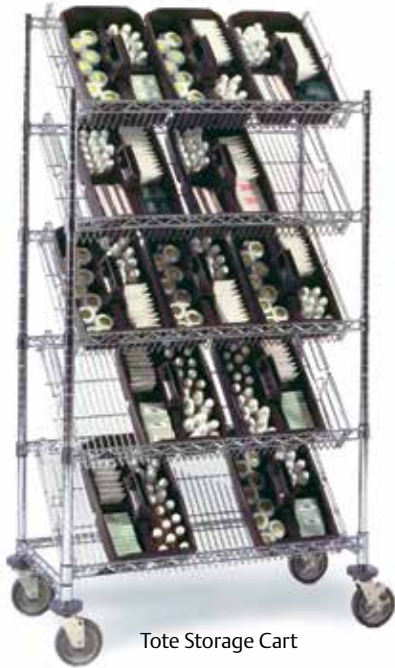

Tote Storage Cart

**Tote Storage Cart
(Slanted Dispenser Racks) — {31.50}**

- Tote storage carts can hold up to twenty 10" (254mm) wide totes.
- Slanted shelves add visibility and accessibility. Loading is quick, easy and organized.
- Open-wire construction and slope of shelves permit instant identification.
- Shelves are adjustable at 1" (25mm) intervals along the height of the post.
- 5" (127mm) casters add mobility, while brakes lock firmly in position.

Shelves	Length		Height		Approx. Pkd. Wt.		Cat. No.
	(in.)	(mm)	(in.)	(mm)	(lbs.)	(kg)	
Four Slanted Shelves One Flat Top Shelf (Pkg. of 12 dividers)	24	610	60	1524	103	46.3	DC15EC
Five Slanted Shelves (Pkg. of 12 dividers)	24	610	60	1524	112	50.4	DC16EC
Four Slanted Shelves One Flat Top Shelf	36	914	60	1524	95	42.7	DC35EC
Five Slanted Shelves	36	914	70	1778	104	46.8	DC36EC
Four Slanted Shelves One Flat Top Shelf	48	1219	60	1524	112	50.4	DC55EC
Five Slanted Shelves	48	1219	70	1778	123	55.3	DC56EC

Metro Tip:
Use the Tote Storage Cart to organize baskets for housekeepers prior to their shift.

Additional Shelves

Additional shelves are 18" (457mm) wide.

Length		Approx. Pkd. Wt.		Cat. No.
(in.)	(mm)	(lbs.)	(kg)	
24	610	10.5	4.7	1824DNC
36	914	14	6.3	1836DNC
48	1219	18	8.1	1848DNC

Additional Retainer

Keeps different types of merchandise separate and in order.

Size Width/Length		Approx. Pkd. Wt.		Cat. No.
(in.)	(mm)	(lbs.)	(kg)	
4x17	102x432	8	3.6	DCR17C

Plastic Shelf Marker

Snaps over shelf edge.
Holds labels 3"x1 1/4" (75x32mm).

Size Width/Length		Cat. No.
(in.)	(mm)	
3x1 1/4	75x32	9990P

Amenity Pick Station — {31.50}

- Organization eliminates hidden, forgotten stock. Pick station allows easy access for storage and dispensing.
- Pick stations available in 24" (610mm) and 30" (760mm) depths with back-up storage area below work surface.
- Work surface area features a raised "ship's edge" on all four sides to contain accidental spills.
- Top slanted shelves provide easy access to amenities.
- 72" (1829mm) overall height.
- 36" (914mm) countertop height.
- Counter units also available. See page 67.

Width (in.)	Width (mm)	Length (in.)	Length (mm)	Cat. No.
24	610	48	1219	SWHPS2448
24	610	60	1524	SWHPS2460
30	760	48	1219	SWHPS3048
30	760	60	1524	SWHPS3060



Amenity Pick Station

Slanted Shelf Carts — {31.05}

Shelves slant backwards to keep items secure during transport.

Width/Length (in.)	Width/Length (mm)	Height		No. of Shelves	Casters	Description	Approx. Pkd. Wt.		Cat. No.
		(in.)	(mm)				(lbs.)	(kg)	
24x36	610x914	62	1575	3	2-BL6P, 2-6P	Heavy-Duty	140	63	AST35MC
24x48	610x1219	62	1575	3	2-BL6P, 2-6P	Heavy-Duty	162	72.4	AST55MC
24x60	610x1524	62	1575	3	2-BL6P, 2-6P	Heavy-Duty	187	84.1	AST65MC
24x36	610x914	59	1500	3	4-5MP Casters	Standard-Duty	105	47.2	AST35DC
24x48	610x1219	59	1500	3	4-5MP Casters	Standard-Duty	125	56.2	AST55DC
24x60	610x1524	59	1500	3	4-5MP Casters	Standard-Duty	150	67.5	AST65DC

Additional Slanted Shelves

Width/Length (in.)	Width/Length (mm)	Approx. Pkd. Wt.		Cat. No. Chrome
		(in.)	(mm)	
24x36	610x914	13	6	SLT2436NC
24x48	610x1219	17	8	SLT2448NC
24x60	610x1524	22	10	SLT2460NC



AST35DC

Hold, transport & organize.

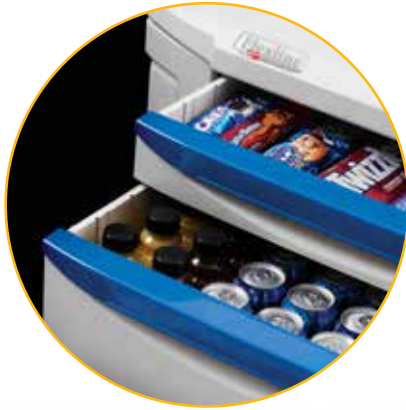

FLMB2

THE MINI BAR RESTOCKING CART

MANEUVERABLE:

- Four 5" (127mm) diameter casters (2 directional, 2 with brake), provide easy maneuverability, control and stability.

STORAGE CAPACITY:

- Recessed side storage areas hold three (3) tilt-out bins on the right and one (1) tilt-out bin and wastebasket on the left side.
- A total of 27" (686mm) of drawer space provides ample room for beverage cans, juice and water bottles.

SECURED SUPPLIES:

- Key lock on right side protects valuable supplies in all drawers and right side tilt-out bins from loss or pilferage.

DURABLE CONSTRUCTION:

- Sturdy polymer construction is extremely easy to clean, and is resistant to cracking, peeling or chipping.
- Full extension drawers have self-closing ball bearing slides to provide easy access to all supplies.
- Spacious work surface provides a smooth writing surface or ample space for prep work.

SANITARY:

- Smooth, rounded corners and seamless cart surfaces simplify cleaning.

MICROBAN® ANTIMICROBIAL PRODUCT PROTECTION:

- Advanced polymer construction has built-in Microban® Antimicrobial Product Protection which inhibits the growth of bacteria, mold, mildew, and fungi that cause odors, stains, and product degradation.

Mini Bar Restocking Carts

Width/Depth/Height (in.) (mm)		Weight (lbs.) (kg)		Drawers	Wastebasket	Tilt-out Bins	Drawer Divider Kit	Cat. No.
33x22x42	838x559x1067	125	57	(3) 6" (152mm)	X	3 (Right)	1*	FLMB1
				(1) 9" (229mm)		1 (Left)		
33x22x42	838x559x1067	125	57	(1) 3" (76mm)	X	3 (Right)	1*	FLMB2
				(1) 6" (152mm)		1 (Left)		
				(2) 9" (229mm)				

*Divider Kit is for one 6" (152mm) or one 9" (229mm) drawer.

Accessories

Description	Model
3" (76mm) Drawer Divider Kit	FL113
6"/9" (152/229mm) Drawer Divider Kit	FL116
Touch Pad Electronic Lock (No Display)*	FL410

*Touch Pad Electronic Locking/Unlocking option is available. Please contact your local Metro Representative.



MetroTrux™ — {31.43}

Units are constructed of an advanced polymer material with molded contours that provide a ruggedized body to endure the toughest daily use. Its contemporary aesthetic provides elegance to fit into any décor. Its innovative design is lightweight and ergonomic and includes “Clean Design” elements featuring Microban® antimicrobial product protection and corrosion proof components for years of reliable service.



Convertible Trux

Height (in.)	Height (mm)	Description	Approx. Pkd. Wt.		Cat. No.
			(lbs.)	(kg)	
72	1829	Trux, Convertible, 2 SS Shelves, 4 Swivel Casters	152	69	TXPA-CLT48S
72	1829	Trux, Convertible, 2 SS Shelves, 2 Swivel/2 Rigid Casters	152	69	TXPB-CLT48S
72	1829	Trux, Bulk with 4 Swivel Casters	128	58	TXPA-BLK48
72	1829	Trux, Bulk with 2 Swivel/2 Rigid Casters	128	58	TXPB-BLK48
73 1/3	1863	Trux, Bulk with 4 Swivel Casters, with Closures	148	67	TXPA-BLK48SEC
73 1/3	1863	Trux, Bulk with 2 Swivel/2 Rigid Casters, with Closures	148	67	TXPB-BLK48SEC
*Trux, Cart Cover, Uncoated, Velcro Close, Navy Blue			5	2	TX-48CVUCNB

All MetroTrux units measure 29 1/2" W x 48" L (749 x 1219mm)
Drain holes and routing slip clips are standard on all MetroTrux units.

* Cart covers are a darker blue than the truck color.
Color block is an approximate shade of Navy Blue color.



Metro incorporates several elements in its product design to support a facility's cleaning protocols:

- Microban® antimicrobial protection helps prevent the growth of stain and odor causing bacteria on the product.
- Advanced polymer and other proprietary finishes provide corrosion resistance
- Smooth rounded corners to allow for easier cleaning

Look for the “red check” symbol for this added protection.



Security Bulk Trux



Bulk Trux



Convertible Linen Truck — {31.12}

Versatile construction allows folding shelves to be positioned horizontally or vertically to configure 3 different truck positions.

- Brake Lock/Swivel Lock combination casters increase flexibility.
- Open-wire design maximizes air circulation and visibility.

Shelf Size		Height (in.)	Height (mm)	Description	Approx. Pkd. Wt.		Cat. No.
Width (in.)	Length (mm)				(lbs.)	(kg)	
Standard-Duty — Chrome							
24x48	610x1219	70	1778	CLT with 3-sided top frame	180	82	CLTS2448C
24x60	610x1524	70	1778	CLT with 3-sided top frame	200	91	CLTS2460C
Standard-Duty — Stainless Steel							
24x60	610x1524	70	1778	CLT with 3-sided top frame	169	77	CLT2460S
Heavy-Duty — Chrome							
24x60	610x1524	70	1778	CLT with 3-sided top frame	241	109	CLTH2460C



CLTH2460C

Material: Chrome Models: Chrome-plated steel dolly and aluminum tubes. Stainless Steel: Stainless steel dolly and aluminum tubes.
Note 1: Casters on above units consist of two 6P and one pair BL6P, 8P and BL8P available on special order.
Note 2: Before employing any of various cart-washing systems, please contact InterMetro Industries Corporation or your Metro representative for special recommendations on casters and for cleaning instructions.

Accessories

Description	Model
Card Holder	CLCHC
Push Handle	PH24NC

EXCHANGE CARTS/TOTES AND BINS



Standard-Duty Cart
(shown with optional slides
and tote boxes)

Transfer/Exchange Carts — {31.56}

- Slanted shelves have 2" (50mm) slant front to back to reduce loss or breakage of items during transport.
- Standard-Duty: mounted on four 5" (127mm) stem casters.
- Heavy-Duty: mounted on aluminum dolly with bumper, two 6" (152mm) swivel casters and one set of brake lock/swivel lock casters.

Description	Width (in.) (mm)	Length (in.) (mm)	Height (in.) (mm)	No. of Shelves	Casters	Approx. Pkd. Wt. (lbs.) (kg)	Cat. No.
Heavy-Duty	24 610	36 914	62 1575	3	2-BL6P, 2-6P	140 64	AST35MC
Heavy-Duty	24 610	48 1219	62 1575	3	2-BL6P, 2-6P	162 73	AST55MC
Heavy-Duty	24 610	60 1524	62 1575	3	2-BL6P, 2-6P	187 84	AST65MC
Standard-Duty	24 610	36 914	59 1495	3	4-5MP	105 47	AST35DC
Standard-Duty	24 610	48 1219	59 1495	3	4-5MP	125 56	AST55DC
Standard-Duty	24 610	60 1524	59 1495	3	4-5MP	150 66	AST65DC

For cart handles, tote box slide accessories, and covers see pages 49 and 54.

MetroTotes Divider Box Line — {16.64}

Metro's Divider Tote Box Line offers safe and efficient storage of items in bulk, or in compartmentalized fashion with the use of optional dividers. Manufactured of polypropylene material, these injection-molded totes are available in white and can be stored and transported in a variety of standard Metro products (e.g. PT Slide Trucks, Super Slide System, etc.).



Outside Dimensions (includes lip) Length x Width (in.) (mm)		Inside Dimensions Length x Width (in.) (mm)		Height O.D. (in.) (mm)	I.D.* (in.) (mm)	Capacity (cu. ft.) (cu. m.)	Approx. Tote Box Wt. (lbs.)	Cat. No.
10 ⁷ / ₈ x8 ¹ / ₄	276x210	9 ¹ / ₈ x6 ¹ / ₂	232x165	3 ¹ / ₂ 89	3 76	.10 0.003	.77	MTB91035W
16 ¹ / ₂ x10 ⁷ / ₈	419x276	14 ⁷ / ₈ x9 ¹ / ₄	378x235	3 ¹ / ₂ 89	3 76	.24 0.007	1.5	MTB92035W
16 ¹ / ₂ x10 ⁷ / ₈	419x276	14 ⁷ / ₈ x9 ¹ / ₄	378x235	6 152	5.5 140	.44 0.012	2.33	MTB92060W
22 ¹ / ₂ x17 ¹ / ₂	572x445	20 ¹ / ₄ x15 ¹ / ₈	514x384	3 76	2.5 64	.44 0.017	2.57	MTB93030W
22 ¹ / ₂ x17 ¹ / ₂	572x445	20 ¹ / ₄ x15 ¹ / ₈	514x384	5 127	4.5 114	.79 0.02	4.0	MTB93050W
22 ¹ / ₂ x17 ¹ / ₂	572x445	20 ¹ / ₄ x15 ¹ / ₈	514x384	6 152	5.5 140	.97 0.027	4.0	MTB93060W
22 ¹ / ₂ x17 ¹ / ₂	572x445	20 ¹ / ₄ x15 ¹ / ₈	514x384	8 203	7.5 191	1.32 0.037	5.25	MTB93080W
22 ¹ / ₂ x17 ¹ / ₂	572x445	20 ¹ / ₄ x15 ¹ / ₈	514x384	12 305	11.5 292	2.03 0.057	6.67	MTB93120W

*Loading height restrictions when using covers or stacking totes.

MetroTote Accessories — {16.64}

Covers and Dividers

For Tote Box	Insert Cover	Dividers	Maximum Tote
MTB91035W	CI91000CLR	Short MDS91035NAT Long MDL91035NAT	7 5
MTB91060W	CI91000CLR		
MTB92035W	CI92000CLR	Short MDS92035NAT Long MDL92035NAT	11 7
MTB92050W	CI92050CLR	MDS92050NAT	11
MTB92060W	CI92000CLR	Short MDS92060NAT Long MDL92060NAT	11 7
MTB93030W	CI93000CLR	Short MDS93030NAT Long MDL93030NAT	15 11
MTB93060W	CI93000CLR	Short MDS93060NAT Long MDL93060NAT	15 11
MTB93080W	CI93000CLR	Short MDS93080NAT Long MDL93080NAT	15 11
MTB93120W	CI93000CLR	Short MDS93080NAT Long MDL93080NAT	15 11

Snap-On Card Holder Clear vinyl with clear window.

Size (in.) (mm)	Cat. No.
4 ¹ / ₂ x8 114x199	OP2501CLR
2 ¹¹ / ₁₆ x5 76x127	OP2535CLR



Stacking Bins

Injection molded from polypropylene base material in natural gray color. All sizes have an open hopper front for easy access to contents and a slot on the back for use on bin holder bars.

Length (in.) (mm)	Width (in.) (mm)	Height (in.) (mm)	Carton Qty.*	Est. Carton Wt. (lbs.)	Cat. No. Natural Polypropylene
8 203	3 ¹ / ₂ 89	4 ¹ / ₈ 105	48	39	SB90835NAT
7 ³ / ₈ 187	4 ¹ / ₈ 105	3 76	48	36	SB90743NAT
10 ⁷ / ₈ 276	5 ¹ / ₂ 140	5 127	24	25	SB91055NAT
14 ³ / ₄ 375	8 ¹ / ₄ 210	7 179	12	18	SB91587NAT
14 ³ / ₄ 375	16 ¹ / ₂ 419	7 179	6	18	SB91516NAT

*Items must be purchased in carton quantities to avoid a broken lot charge.

**Pricing based on quantity ordered. Please consult your Metro representative.

Slanted-Shelf Merchandisers/Dispenser Racks — {50.50}

Slanted shelves add visibility and accessibility. Loading is quick, easy, and organized.

- Open-wire construction and slope of shelves permit instant identification.
- System eliminates duplication and confusion in ordering.
- Shelves are adjustable at 1" (25mm) intervals along the height of the post.
- 5" (127mm) casters add mobility, while brakes lock firmly in position.

Width (in.) (mm)		Length (in.) (mm)		Height (in.) (mm)		Approx. Pkd. Wt. (lbs.) (kg)		Shelves	Cat. No.
18	457	24	610	60	1524	103	46.3	Four Slanted Shelves One Flat Top Shelf (Pkg. of 12 dividers)	DC15EC
18	457	24	610	70	1780	112	50.4	Five Slanted Shelves (Pkg. of 12 dividers)	DC16EC
18	457	36	914	60	1524	95	42.7	Four Slanted Shelves One Flat Top Shelf	DC35EC
18	457	36	914	70	1780	104	46.8	Five Slanted Shelves	DC36EC
18	457	48	1219	60	1524	112	50.4	Four Slanted Shelves One Flat Top Shelf	DC55EC
18	457	48	1219	70	1780	123	55.3	Five Slanted Shelves	DC56EC



DC56EC

Triangle Shelves — {10.04}

Put unused corner space to work while keeping traffic aisles clear.

- Shelf sizes corresponding to width (depth) of shelving for add-on capabilities.
- Shelves attach to standard Super Erecta or quikSLOT posts, see pages 42 and 199.

Size Width (in.) (mm)		Approx. Pkd. Wt. (lbs.) (kg)		Cat. No. Chrome	Cat. No. Black
18	457	15½	7	H18TRC	H18TRB
24	610	21½	10	H24TRC	H24TRB

Weight load capacity: 200 lbs. (91kg) per shelf; 400 lbs. (182kg) per unit.

Triangle Shelving Unit with four triangle shelves and three Super Erecta posts.



Move more product with the look that sells.

Wine Cart

Mobile wine merchandiser is perfect for creating “impulse” opportunities. The Wine Cart consists of the following components:

- 2 — 1436NC shelves — see page 42
- 1 — 1236CSNC cantilever shelf — see page 46
- 2 — 13P posts cut to 7" (179mm) — see page 42
- 2 — 27UP posts — see page 42
- 2 — 5M swivel casters — see page 50
- 2 — 5MB swivel/brake casters — see page 50



Wine Cart



3KR366FC Keg Handling Rack

HD Super™ Beer Keg Handling Racks — {10.70}

Withstands the heavy load of full kegs and the repeated impact of being loaded and unloaded. Doubles storage capacity and provides a neat, orderly way to store kegs for easier inventory and stock rotation.

- Constructed of sturdy HD Super™ components, with 1⁵/₈" (41mm) diameter posts.

Shelf Length/Height (in.)	Shelf Length/Height (mm)	Shelves*	Keg 1/2 Barrel Storage Capacity	Approx. Pkd. Wt. (lbs.)	Approx. Pkd. Wt. (kg)	Cat. No. Chrome
42x56 ¹ / ₈	1067x1424	2-D	4	118	53.1	2KR345DC
60x56 ¹ / ₈	1524x1424	2-D	6	147	66.1	2KR365DC
42x56 ¹ / ₈	1067x1424	1-D	4	87	39.1	KR345DC
60x56 ¹ / ₈	1524x1424	1-D	6	104	46.8	KR365DC
42x64 ¹ / ₈	1067x1628	1-D, 2-S	2	121	54.4	3KR346FC
60x64 ¹ / ₈	1524x1628	1-D, 2-S	3	151	67.9	3KR366FC
42x64 ¹ / ₈	1067x1628	1-D, 1-S	4	112	50.4	2KR346MC
60x64 ¹ / ₈	1524x1628	1-D, 1-S	6	137	61.6	2KR366MC

*D = dunnage shelf; S = solid shelf; all shelves are 18" (457mm) wide. All models include foot plates for stability and easy leveling.



WC257C Cradle Shelving

Super Erecta® Cradle Wine Shelving — {10.48}

Each bottle is supported individually in a cradle formed by the wires of the shelf, so it cannot roll or bump against adjacent bottles.

- Open-wire construction keeps bottles and labels highly visible for easy reading and selection.
- Shelves, spaced 5" (127mm) apart, provide easy access to bottles for loading or removal and permit air to circulate freely around the bottles.

Width/Length (in.)	Width/Length (mm)	Overall Height (in.)	Overall Height (mm)	Capacity (750ml bottles)	Approx. Pkd. Wt. (lbs.)	Approx. Pkd. Wt. (kg)	Cat. No. Chrome
14x36	355x914	74 ³ / ₄	1899	126	112	51	WC237C
14x36	355x914	86 ³ / ₄	2203	153	133	60	WC238C
14x48	355x1219	74 ³ / ₄	1899	168	133	60	WC257C
14x48	355x1219	86 ³ / ₄	2203	204	160	73	WC258C

All models include foot plates for stability and easy leveling.



WB257C Bulk Shelving

Super Erecta® Bulk Storage Wine Shelving — {10.47}

Permits storage of a large quantity of wines in a limited space — an average of one case per linear foot (350mm) of shelf.

- Holds bottles at an upward slant of 10° to keep corks moist.
- Open-wire construction permits air flow, which is critical in maintaining the proper temperature.
- Units are enclosed by back and side panels which keep bottles secure and prevent accidents.
- For security from loss or pilferage, optional doors, which can be locked with a padlock, are available for the 16-case unit.

Width/Length (in.)	Width/Length (mm)	Overall Height (in.)	Overall Height (mm)	Capacity (Cases of 750ml bottles)	Approx. Pkd. Wt. (lbs.)	Approx. Pkd. Wt. (kg)	Cat. No. Chrome
14x36	355x914	74 ³ / ₄	1899	12	138	63	WB237C
14x36	355x914	86 ³ / ₄	2203	15	168	76	WB238C
14x48	355x1219	74 ³ / ₄	1899	16	168	76	WB257C
14x48	355x1219	86 ³ / ₄	2203	20	204	93	WB258C

All models include foot plates for stability and easy leveling.

Basic Wine Shelving Components — {10.49}

Posts with Foot Plate



Overall Height		Approx. Pkd. Wt. Each		Cat. No.
(in.)	(mm)	(lbs.)	(kg)	
74 ³ / ₄	1899	4.5	2.0	74FPC
86 ³ / ₄	2203	5.5	2.5	86FPC

Wall Clamps

Give single units greater stability.

Cat. No. 9984C



Wall Clamp

Templates

For assembling bin shelving. Included in standard unit. Request #C05-077*

14" (355mm) Wall Mounts

Both types of wine shelves can be wall-mounted. See pages 80 and 81 for 14" (355mm) direct and post-type wall mounts.

14" (355mm) Cradle Shelves

Width/Length		Capacity (750ml bottles)	Approx. Pkd. Wt.		Cat. No.
(in.)	(mm)		(lbs.)	(kg)	
14x36	355x914	9	7	3.2	W1436NC
14x48	355x1219	12	8.5	3.8	W1448NC

Enclosure Components — {10.49}

End Panels*

Two required per unit (one for each end)

Width	Height	Use With	Approx. Pkd. Wt.		Cat. No.
(in.) (mm)	(in.) (mm)	Posts	(lbs.)	(kg)	
13 330	60 1524	74FPC	10.5	4.7	EP27C
13 330	75 1905	86FPC	12.5	5.6	EP28C

*For end and back panels to fit properly, there must be a shelf spaced every 15" (381mm) as in the standard 15" (381mm) spacing for bulk storage wine units and 5" (127mm) spacing for cradle wine units.

Bin Components for Bulk Storage Units — {10.49}

Bin Dividers

Used to separate bottles.

Width	Height	Approx. Pkd. Wt.		Cat. No.
(in.) (mm)	(in.) (mm)	(lbs.)	(kg)	
12 ¹ / ₂ 317	19 482	1.5	.67	BD15C

Bottle Supports

Use when bottles are to be stacked in bins. For use with 1436NC or 1448NC shelves spaced 15" (381mm) apart.

Length	Shelf Length	Approx. Pkd. Wt.		Cat. No.
(in.) (mm)	(in.) (mm)	(lbs.)	(kg)	
35 889	36 914	1.5	.67	BS3C
47 1194	48 1219	2	.9	BS5C



14" (355mm) Flat Wire Shelves

Width/Length		Approx. Pkd. Wt.		Cat. No.
(in.)	(mm)	(lbs.)	(kg)	
14x36	355x914	9.5	4.3	1436NC
14x48	355x1219	12	5.4	1448NC

Back Panels*

36" units require two back panels per unit. 48" units require three back panels per unit.

Width	Height	Use With	Approx. Pkd. Wt.		Cat. No.
(in.) (mm)	(in.) (mm)	Posts	(lbs.)	(kg)	
14 ¹ / ₂ 368	60 1524	74FPC	11	5.0	BP27C
14 ¹ / ₂ 368	75 1905	86FPC	13	5.9	BP28C

*For end and back panels to fit properly, there must be a shelf spaced every 15" (381mm) as in the standard 15" (381mm) spacing for bulk storage wine units and 5" (127mm) spacing for cradle wine units.

Wine Shelving Accessories — {10.47/10.48/10.49}

Door Set (Fits only WB257C and WC257C)

Width	Height	Fits Units	Approx. Pkd. Wt.		Cat. No.
(in.) (mm)	(in.) (mm)		(lbs.)	(kg)	
51 1295	60 1524	48" longx74 ³ / ₄ " high (1219x1898mm)	42	18.9	ED57C

Joining Hook

Used when units are placed back to back or end to end.



Width	Depth	Height	Cat. No.
(in.) (mm)	(in.) (mm)	(in.) (mm)	
2 ¹ / ₃₂ 15.2	1 ⁵ / ₈ 40.6	2 ¹ / ₄ 57	JH2C

TERMS AND CONDITIONS (SUBJECT TO CHANGE)



Standard Terms and Conditions of Sale

These Terms and Conditions, the attendant quotation or acknowledgment, and all documents incorporated by specific reference therein will be the complete and exclusive statement of the terms of the agreement governing the sale of goods ("Goods") by InterMetro Industries Corporation and its divisions ("Seller") to Customer ("Buyer"). Buyer's acceptance of the Goods will manifest Buyer's assent to these terms and conditions. If these terms and conditions differ in any way from the terms and conditions of Buyer's order, or other documentation, this document will be construed as a counteroffer and will not be deemed an acceptance of Buyer's terms and conditions which conflict herewith, and to the extent there is any conflict between the terms and conditions herein and any purchase order or other document from the Buyer, the terms and conditions herein shall govern and prevail.

1. Prices:

Unless otherwise specified in writing by Seller, Seller's price for the Goods shall remain in effect for thirty (30) days after the date of Seller's quotation or acknowledgment of Buyer's order for the Goods, whichever occurs first, provided an unconditional, complete authorization for the immediate shipment of the Goods is received and accepted by Seller within such time period. If such authorization is not received by Seller within such thirty (30) day period, Seller shall have the right to change the price for the Goods to Seller's price for the Goods at the time of shipment.

2. Taxes:

Any tax or governmental charge or increase in same hereafter becoming effective increasing the cost to Seller of producing, selling or delivering the Goods or of procuring material used therein, and any tax now in effect or increase in same payable by the Seller because of the manufacture, sale or delivery of the Goods, may at Seller's option, be added to the price.

3. Terms and Payment:

Subject to the approval of Seller's Credit Department, terms are 1% ten (10) days net thirty (30) days from date of Seller's invoice in U.S. currency. Payment shall be made in full without set-off, counterclaim or withholding of any kind. Freight, handling and other service charges are not subject to discount. If any payment owed to Seller is not paid when due, it shall bear interest at a rate to be determined by Seller, which shall not exceed the maximum rate permitted by law, from the date on which it is due until it is paid. Seller shall have the right, among other remedies, either to terminate the agreement or to suspend further performance under this and/or other agreements with Buyer. Buyer shall be liable for all expenses, including attorneys' fees, relating to the collection of past due amounts.

Forms of payment accepted by InterMetro include: Cash, Check, Wire Transfer, Automated Clearing House Network, and Credit Card. Credit Card payments will be subject to a 3% charge.

Minimum Order, Returns, Cancellations, Changes and Configured Products:

Orders under \$250.00 net, routed prepaid via small package carriers (UPS and FedEx), will be charged \$39.00 freight and handling. Orders under \$250.00 net, routed air freight, LTL, third party, or collect, will be charged a handling fee of \$29.00 plus actual freight costs when applicable. (All amounts in U.S. currency.)

Written approval is required from the Seller's factory to return merchandise. All merchandise must be returned within forty-five (45) days from the invoice date and be returned in original, unopened, and resalable packaging. A Return Merchandise Authorization (RMA) must be obtained through Seller's customer service department prior to returning the product. All costs of returned items, including shipping and insurance shall be the responsibility of the Buyer.

1. Minimum return value - \$200.00 net.
2. Restocking charge - 15% (\$50.00 minimum).

Exceptions - Special orders of cut posts, made to order dollies, cart covers, Designer Color product, Configured Products (defined as *C5 Heated Cabinets, Lifeline, Flexline, Starsys, MetroBasix Pus, MetroBasix, Lionville Fixtures, Lionville iPoint Carts, and Lionville Med carts*), and custom or made-to-order are not returnable. Accessories for Configured Products are returnable at the discretion of Seller.

All order change requests must be requested through Seller's customer service. Changes/cancellations, for exception items listed above, requested within seven (7) workdays of the scheduled ship date that will impact order production will incur, at minimum, a 20% Change/Cancellation Fee, up to the full order value, depending on the percentage of the order completed. Customer service will relay percentage of order completed along with the Change/Cancellation Fee amount. Prior to Seller accepting the change, a revised purchase order (including associated Fee) is required. Orders for C5 cabinets with an "A" suffix are non-cancellable.

Buyer may request changes or additions to the Goods consistent with Seller's specifications and criteria. In the event such changes or additions are accepted by Seller, Seller may revise the price and delivery schedule.

Seller reserves the right to change designs and specifications for the Goods without prior notice to Buyer, except with respect to Goods being made-to-order for Buyer.

4. Shipment and Delivery:

Shipments are made FOB Seller's shipping point. Seller reserves the right to split orders based on the FOB Shipping Point. Order consolidation is available for an additional charge. Buyer should contact customer service for more information. Any claims for shortages or damages suffered in transit shall be submitted by the Buyer directly to the carrier. While Seller will use all reasonable commercial efforts to maintain the delivery date acknowledged or quoted by Seller, all shipping dates are approximate. Seller reserves the right

to make partial shipments and to segregate "specials" and made-to-order Goods from normal stock Goods. Seller shall not be bound to tender delivery of any Goods for which Buyer has not provided shipping instructions.

5. Limited Warranty:

(a) Subject to the limitations of Section 6, Seller warrants that the Goods will be free from defects in material and workmanship under normal use, service and maintenance for a period of one year (unless otherwise specified by Seller in writing) from the date of shipment of the Goods by Seller. THIS IS THE SOLE AND EXCLUSIVE WARRANTY GIVEN BY SELLER WITH RESPECT TO THE GOODS AND IS IN LIEU OF AND EXCLUDES ALL OTHER WARRANTIES, EXPRESS OR IMPLIED, ARISING BY OPERATION OF LAW OR OTHERWISE, INCLUDING WITHOUT LIMITATION, MERCHANTABILITY OR FITNESS FOR A PARTICULAR PURPOSE WHETHER OR NOT THE PURPOSE OR USE HAS BEEN DISCLOSED TO SELLER IN SPECIFICATIONS, DRAWINGS OR OTHERWISE, AND WHETHER OR NOT SELLER'S PRODUCTS ARE SPECIFICALLY DESIGNED AND/OR MANUFACTURED BY SELLER FOR BUYER'S USE OR PURPOSE.

This warranty does not extend to any losses or damages due to misuse, accident, abuse, neglect, normal wear and tear, unauthorized modification or alteration, use beyond rated capacity, or improper installation, maintenance or application. To the extent that Buyer or its agents has supplied specifications, information, representation of operating conditions or other data to Seller in the selection or design of the Goods and the preparation of Seller's quotation, and in the event that actual operating conditions or other conditions differ from those represented by Buyer, the warranties or other provisions contained herein which are affected by such conditions shall be null and void. If, within thirty (30) days after Buyer's discovery of any warranty defects within the warranty period, Buyer notifies Seller thereof in writing, Seller shall, at its option, repair or replace F.O.B. point of manufacture, or refund the purchase price for that portion of the Goods found by Seller to be defective. Failure by Buyer to give such written notice within the applicable time period shall be deemed an absolute and unconditional waiver of Buyer's claim for such defects. Goods repaired or replaced during the warranty period shall be covered by the foregoing warranty for the remainder of the original warranty period or ninety (90) days, whichever is longer. Buyer assumes all other responsibility for any loss, damage, or injury to persons or property arising out of, connected with, or resulting from the use of Goods, either alone or in combination with other products/components.

(b) All batteries sold by Seller to Buyer hereunder receive the Goods warranty under Sections 5 and 6 with a warranty period of one year from the warranty start date. Battery adjustments will be prorated over a one year period.

(c) Seller has no obligation under the warranties provided in Sections 5 and 6 to correct any software programming error(s) that do not significantly adversely affect the use of the Goods; however, such programming error



Standard Terms and Conditions of Sale (continued)

corrections shall be made available from time to time to those Buyers purchasing applicable contract maintenance services from the Seller.

(d) SECTIONS 5 AND 6 APPLY TO ANY ENTITY OR PERSON WHO MAY BUY, ACQUIRE OR USE SELLER'S GOODS, INCLUDING ANY ENTITY OR PERSON WHICH BUYS THE GOODS FROM SELLER'S DISTRIBUTOR AND SUCH ENTITY OR PERSON SHALL BE BOUND BY THE LIMITATIONS THEREIN.

6. Limitation of Remedy and Liability:

THE SOLE AND EXCLUSIVE REMEDY FOR BREACH OF ANY WARRANTY HEREUNDER (OTHER THAN THE WARRANTY PROVIDED UNDER SECTION 11) SHALL BE LIMITED TO REPAIR, REPLACEMENT OR REFUND OF THE PURCHASE PRICE OF THE AFFECTED GOODS. SELLER SHALL NOT BE LIABLE FOR DAMAGES CAUSED BY DELAY IN PERFORMANCE, AND IN NO EVENT, REGARDLESS OF THE FORM OF THE CLAIM OR CAUSE OF ACTION (WHETHER BASED IN CONTRACT, INFRINGEMENT, NEGLIGENCE, STRICT LIABILITY, OTHER TORT OR OTHERWISE), SHALL SELLER'S LIABILITY TO BUYER AND/ OR ITS CUSTOMERS EXCEED THE PRICE PAID BY THE BUYER FOR THE SPECIFIC GOODS PROVIDED BY SELLER GIVING RISE TO THE CLAIM OR CAUSE OF ACTION. BUYER AGREES THAT IN NO EVENT SHALL SELLER'S LIABILITY TO BUYER AND/OR ITS CUSTOMERS EXTEND TO OR INCLUDE INCIDENTAL, CONSEQUENTIAL OR PUNITIVE DAMAGES. THE TERM "CONSEQUENTIAL DAMAGES" SHALL INCLUDE, BUT NOT BE LIMITED TO, LOSS OF ANTICIPATED PROFITS, LOSS OF USE, LOSS OF REVENUE, COST OF CAPITAL AND DAMAGE OR LOSS OF OTHER PROPERTY OR EQUIPMENT.

It is expressly understood that any technical advice furnished by Seller with respect to the use of the Goods is given without charge, and Seller assumes no obligation or liability for the advice given, or results obtained; all such advice being given and accepted at Buyer's risk.

7. Excuse of Performance:

Seller shall not be liable for delays in performance or for non-performance due to acts of God; acts of Buyer; war, riot, fire, flood, power surges, other severe weather, sabotage, or epidemics; strikes or labor disturbances; governmental requests, restrictions, laws, regulations, orders or actions; unavailability of or delays in transportation; default of suppliers; or unforeseen circumstances or any events or causes beyond Seller's reasonable control. Deliveries may be suspended for an appropriate period of time as a result of the foregoing. If Seller determines that its ability to supply the total demand for the Goods is hindered, limited or made impracticable due to causes addressed in this Section 7, Seller may allocate its available supply of the Goods or such material (without obligation to acquire other supplies of any such Goods or such materials) among itself and its purchasers on such basis as Seller determines to be equitable without liability for any failure of performance which may result therefrom. Deliveries suspended or not made by reason of this Section 7 may be canceled by Seller upon notice to Buyer without liability, but the balance of the agreement shall otherwise remain unaffected.

8. Software:

Notwithstanding any other provision herein to the contrary, Seller or applicable third party licensor to Seller shall retain all rights of ownership and title in its respective Software, including without limitation all rights of ownership and title in its respective copies of such Software. Except as otherwise provided herein, Buyer is hereby granted a nonexclusive, non-transferable royalty free license to use the Software incorporated into the Goods solely for purposes of Buyer properly utilizing such Goods purchased from Seller. All other Software shall be furnished to, and used by Buyer only after execution of Seller's (or the licensor's) applicable standard license agreement.

9. Tooling:

Tool, die, and pattern charges, if any, are in addition to the price of the Goods and are due and payable upon completion of the tooling. All such tools, dies and patterns shall be and remain the property of Seller. Charges for tools, dies, and patterns do not convey to Buyer title, ownership interests in, or rights to possession or removal, nor prevent their use by Seller for other purchasers, except as otherwise expressly provided by Seller and Buyer in writing with reference to this provision.

10. Assignment:

Buyer shall not assign its rights or delegate its duties hereunder or any interest therein or any rights hereunder without the prior written consent of the Seller, and any such assignment, without such consent, shall be void.

11. Patents and Copyrights:

Subject to Section 6, Seller warrants that the Goods sold, except as are made specifically for Buyer according to Buyer's specifications, do not infringe any valid U.S. patent or copyright in existence as of the date of delivery. This warranty is given upon the condition that Buyer promptly notify Seller of any claim or suit involving Buyer in which such infringement is alleged, and that Buyer cooperate fully with Seller and permit Seller to control completely the defense or compromise of any such allegation of infringement. Seller's warranty as to use only applies to infringements arising solely out of the inherent operation (1) of such Goods, or (2) of any combination of Goods in a system designed by Seller. In the event such Goods, singularly or in combination, are held to infringe a U.S. patent or copyright in such suit, and the use of such Goods is enjoined, or in the case of a compromise by Seller, Seller shall have the right at its option and expense to: (i) procure for Buyer the right to continue using such Goods; or (ii) replace them with non-infringing Goods; or (iii) modify same to become non-infringing; or (iv) grant Buyer a credit for the depreciated value of such Goods and accept return of them.

All information (including but not limited to pricing, descriptions, specifications and drawings) provided by Seller in email, literature, website, quotations, order acknowledgements or other is proprietary in nature and deemed CONFIDENTIAL intended for use solely by the designated party.

Seller's name, logo, designs, drawings, trademarks and other intellectual property remains the property of Seller and may not be disclosed, reproduced, or used without its prior written consent.

12. General Provisions:

These terms and conditions supersede all other communications, negotiations and prior oral or written statements regarding the subject matter of these terms and conditions. No change, modification, rescission, discharge, abandonment or waiver of these terms and conditions shall be binding upon the Seller unless made in writing and signed on its behalf by a duly authorized representative of Seller. No conditions, usage of trade, course of dealing or performance, understanding or agreement purporting to modify, vary, explain, or supplement these terms and conditions shall be binding unless hereafter made in writing and signed by the party to be bound, and no modification or additional terms shall be applicable to this agreement by Seller's receipt, acknowledgment, or acceptance of purchase orders, shipping instruction forms, or other documentation containing terms at variance with or in addition to those set forth herein. Any such modifications or additional terms are specifically rejected by Seller. No waiver by either party with respect to any breach or default or of any right or remedy, and no course of dealing, shall be deemed to constitute a continuing waiver of any other breach or default or of any other right or remedy, unless such waiver be expressed in writing and signed by the party to be bound. All typographical or clerical errors made by Seller in any quotation, acknowledgment or publication are subject to correction.

The validity, performance, and all other matters relating to the interpretation and effect of this agreement shall be governed by the law of the Commonwealth of Pennsylvania. Buyer and Seller agree that the proper venue for all actions arising in connection herewith shall be only in the Court of Common Pleas of Luzerne County, Pennsylvania or the United States District Court for the Middle District of Pennsylvania, and the parties agree to submit to such exclusive jurisdiction. No action, regardless of form, arising out of transactions relating to this agreement or underlying agreement, may be brought by either party more than two (2) years after the cause of action has accrued. The United Nations Convention for the International Sales of Goods shall not apply to this agreement.

Buyer agrees that all applicable import, export control and sanctions laws, regulations, orders and requirements, as they may be amended from time to time, including without limitation those of the United States, the European Union and the jurisdictions in which Seller and Buyer are established or from which items may be supplied, and the requirements of any licenses, authorizations, general licenses or license exceptions relating thereto will apply to its receipt and use of hardware, software, services and technology. Buyer agrees furthermore that it shall not engage in any activity that would expose Seller or any of its affiliates to a

Standard Terms and Conditions of Sale (continued)

risk of penalties under laws and regulations of any relevant jurisdiction prohibiting improper payments, including but not limited to bribes, to officials of any government or of any agency, instrumentality or political subdivision thereof, to political parties or political party officials or candidates for public office, or to any employee of any customer or supplier. Buyer agrees to comply with all appropriate legal, ethical and compliance requirements. To the extent applicable, and except to the extent otherwise required by applicable law, Seller shall have no responsibility for the collection, treatment, recovery or disposal of (i) the Goods or any part thereof when they are deemed by law to be 'waste' or (ii) any items for which the Goods or any part thereof are replacements. If Seller is required by applicable

law, including waste electrical and electronic equipment legislation, European Directive 2002/96/EC (WEEE) and related legislation in EU Member States, to dispose of 'waste' Goods or any part thereof, Buyer shall, unless prohibited by applicable law, pay Seller, in addition to the Contract Price, either (i) Seller's standard charge for disposing of such Goods or (ii) if Seller does not have such a standard charge, Seller's costs (including all handling, transportation and disposal costs and a reasonable mark-up for overhead) incurred in disposing of such Goods. GOODS AND SERVICES PROVIDED HEREUNDER ARE NOT SOLD OR INTENDED FOR USE IN ANY NUCLEAR OR NUCLEAR RELATED APPLICATIONS. Buyer (i) accepts Goods and Services in accordance with the foregoing restriction, (ii)

agrees to communicate such restriction in writing to any and all subsequent purchasers or users and (iii) agrees to defend, indemnify and hold harmless Seller and Seller's Affiliates from any and all claims, losses, liabilities, suits, judgments and damages, including incidental and consequential damages, arising from use of Goods and Services in any nuclear or nuclear related applications, whether the cause of action be based in tort, contract or otherwise, including allegations that the Seller's liability is based on negligence or strict liability.

All purchases made by Buyer from Seller are subject to Seller's Warranty Remedy and Return Policy.



Cabinets

- C5 146-187
- Delivery/Storage 195-196
- Heated Banquet 188-194

Carriers

- Mightylite..... 140-143

Carts

- Basket 127
- Breakfast..... 96
- Bussing..... 124-125
- Dish & Tray..... 207
- Ice 207
- Linen 217
- Lodgix 211-213
- Mini Bar Restocking 216
- Slanted Shelf..... 214-215
- Stem Caster 20, 39, 48

Carts Utility

- Accessories 127
- Deep Ledge..... 127
- MetroMax i 19, 21, 83
- MetroMax Q 21
- myCart 124-125
- myFold 126
- Wire: Heavy Duty 129
- Wire: Standard Duty..... 128
- Wine 219

Caster Guide 51

Casters

- Antimicrobial 50
- HD Super 78
- Decorative 51
- Plate 53
- Polymer 18, 50
- Stainless Steel 18, 50
- Stem Casters 18, 50

Counter Units 97

Draining Grate 206

Dollies

- Cup/Glass Rack..... 206
- Made-To-Order/Truck..... 52
- Poker Chip 204-205

Hangers

- Extension Display 60
- Garment Tube 59
- Rail 58
- Swing 60

High-Density Storage

- qwikTRAK 108, 110-111
- Top-Track 109, 112-115

Housekeeping

- Housekeeping Carts.. 210-211
- Houserunner Carts 212
- Linen Trucks & Carts 217
- Lodgix Carts 211
- Mini Bar Restocking Cart.. 216
- Totes & Bins 218
- Transfer Exchange..... 215
- Valet/Special Delivery 213

Posts

- Designer 43
- HD Super 78
- MetroMax i 14, 16
- MetroMax Q 16
- qwikSLOT 66, 67, 68
- Super Erecta
SiteSelect..... 35, 37, 42

Racks

- Beer Keg..... 220
- Can 26
- Drying 28, 207
- Dunnage 130-131
- Platform..... 102
- Pot & Pan 207
- Slanted Shelf
Merchandising 219
- Tray Drying..... 28

Racks, Mobile Pan & Tray

- Adjustable..... 198
- End Load 197-199
- Oval Trays 200
- Portable Wire Prep..... 197
- Roll In 197
- Side Load 197-199
- Wire Bun Pan 197

**Security Trucks
& Units**..... 132-137

Shelving

- Cantilever..... 104
- Convenience Pak..... 46
- Designer 43
- Drop Mat..... 69
- Dunnage 46, 79
- Erecta..... 40-43, 77
- HD Super 78-79
- Hi-Rise 119
- MetroMax i Polymer 12
- MetroMax 4 Polymer 14
- MetroMax Q Polymer
Wire Hybrid..... 16
- qwikSLOT 66-70
- Seismic 120-121
- SmartLever 93-95

Starter & Add-On Units

- MetroMax i 13
- MetroMax 4 15
- MetroMax Q 17
- Super Adjustable
Super Erecta 38
- Super Erecta Pro..... 32-35
- Super Adjustable
Super Erecta 36-39
- Super Erecta Shelf
— Solid 74-75
- Super Erecta Shelf
— Wire 40-49
- Triangle 219
- Wine 220-221

Shelving Accessories

- Baskets 27, 59, 60
- Bins 72-73
- Cart Covers..... 62, 213
- Color Identification Tubes... 61
- Dividers..... 22, 23, 55, 69
- Enclosure Panels 24, 56
- Foot Plates 14, 47
- Glides..... 47
- Handles 19, 54
- Hooks..... 38, 58
- Joining Clamps..... 47, 68
- Keyboard Tray 63
- Label Holders 25, 35, 61
- Ledges..... 22, 23, 55
- Leveling Feet 47
- Post Clamps 14, 47
- Rods & Tabs 57
- Shelf Inlays..... 58
- Shelf Markers..... 25, 35, 61
- Slides 26, 59
- Split Sleeves 47, 104
- Three-Sided Frames 27, 57
- Tote Boxes 218
- Tow Bar Assembly 54

Wall Shelving

- Brackets..... 86, 95
- Erecta Shelf..... 88
- MetroMax i 90
- SmartWall..... 82-87
- Super Erecta Shelf 88-89

Ware Handling

- Poker Chip
Dish Dollies 204-205
- Side-Load Dish &
Tray Carts..... 206

WorkStations

- PrepMate 91-92
- SmartLever 93-95
- SmartStations..... 96-97

Work Tables

- & Accessories** 98-104

Look inside for what's new.



NEW PrepMate™
MultiStation
pg.91



NEW Mightylite™
Insulated Food Carriers
pg.139



NEW SmartLever™
Multifunctional Storage
& Workstations
pg.93



NEW MetroMax® 4
All-Polymer Shelving System
pg.14

Corporate Headquarters
651 North Washington Street
Wilkes-Barre, PA 18705
Phone: +1 570 825 2741
Fax: +1 570 825 2852

U.S. & Canada Customer Service
Phone: 1.800.992.1776
Fax (PA): +1 800 638 9263
Fax: (CA): +1 800 638. 3292

**International Sales/
Customer Service Offices**
Middle East/Africa/India
Dubai-United Arab Emirates
Phone: +971 4 811 8286
Fax: +971 4 886 5465

Asia/Pacific
Singapore
Phone: +65 6829 5382

Latin America
Mexico
Phone: +52 33 362 778 30

Europe
The Netherlands
Phone: +31 76 587 7550
Fax: +31 76 581 1313

www.metro.com

2018/2019
LO4-029 6/18

Information and specifications are subject to change without notice. Please confirm at time of order.

© 2018 InterMetro Industries Corporation, Wilkes-Barre, PA 18705



We put space to work.

an Ali Group Company



The Spirit of Excellence